

Emmaus Visitor

JANUARY, 2013

Mark Your Calendar for Annual Meeting

Mark your calendars for the annual meeting of Emmaus, to be held January 27 at 10:45 a.m. Agenda items



will include FaithWorks, refinancing of our current loan, and suggestions for capital improvements.

Emmaus to Host Employment Classes

Racine Vocational Ministries (RVM) will hold employment preparation classes in our Sunset Room from 9:00 a.m. to 3:00 p.m. Monday, January 14 through Thursday, January 17. "Solutions for Success" is a basic training program for unemployed and underemployed adults.

Emmaus members are needed to make and to serve coffee and lunch to participants in the Solutions for Success program at Emmaus. Can you bake bars or cookies or donate fruit for 10-15 people?

Volunteers are needed to serve a light lunch on September 14, 15, or 16. (The group will order out for pizza on Thursday.) Funds are

available to reimburse for groceries purchased for the lunches.

RVM began Solutions for Success in 2003. After participants complete the four-day Solutions for Success

training, they become eligible for job placement. RVM works with employers to match participants with jobs, and provides continuing one-on-one job counseling after its graduates are employed.

For more information about RVM, call 633-8660.

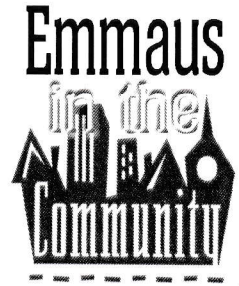

Emmaus Evangelical Lutheran Church "Sent Forth by God's Blessing" e-mail: emmausracine@sbcglobal.net http://www.emmaus-racine.org	1925 Summit Avenue Racine, Wisconsin 53404 Phone: 262 634-5515 Fax 262 634-0835
---	--

Pastoral Acts

Baptism: Maxwell Thomas Schultz December 26, 2012	Max is the son of Adam and Kate (Mason) Schultz. Adam is a son of the congregation, now living in Fairfax, Virginia. Max's sponsors are Austin Schultz and Sarah Kimou.
Confirmation: December 8, 2012	Bishop Jeff Barrow and Pastor Jhon Freddy Correa presided over the confirmation of six new members of Emaús congregation.
Funerals: Jose Cruz December 7, 2012	Jose Cruz, 80, came here from Zacatecas in Mexico, where he owned a farm. He leaves behind his wife, Saturnina, their children and grandchildren.
Isabelle Traeger Barry December 22, 2012	Isabelle is the sister of Ruth Estep. A longtime member of Emmaus before moving to Menomonee Falls in 1998, she was a member of the Altar Guild. Music was a very important thing in her life. She played clarinet, piano, and organ. She retired from nursing in 1976; her husband, Elmer, died in 1988.

Lydia Circle Meets January 9

All women of the church are invited to attend a time of study and hospitality at 1:30 p.m. Wednesday,

January 9. The monthly gathering meets in the Sunset Room on the second Wednesday of the month.

Emmaus Staff & Worship Times

Pastors: Rev. Mary L. Janz 1530 S. Main Street, 53403 262/633-3059
 Rev. Jhon Freddy Correa 1909 Summit Ave. 53404 414/881-1403
Church office: Paul Berge emmausracine@sbcglobal.net
Education Coord.: Nancy Smith nnsdaisy@aol.com
Director Outreach: Liliana Moncada moncada.liliana@hotmail.com
Accompanist: Brenda Trumbauer brenda6175@earthlink.net
Custodians: Rich Benson & Antelmo Hernandez

English language services are held at Emmaus every Saturday evening at 5:00, and Sunday mornings at 9:15. Spanish language services meet at noon on Sunday.

Emmaus office hours are 9:00 a.m. to 3:00 p.m. Monday through Friday.

The VISITOR is published monthly September to July. The deadline for the February VISITOR is January 15. Submit articles to Paul Berge's attention by mail or by e-mail.

Emmaus Visitor

Vol. 41, No. 5

January, 2013

Year End Improvements Made

One of the few times in the year when there is any lull in church activities is the time between Christmas and the first of the year. This year we are taking advantage of the time to:

- Have the kitchen walls and cupboards professionally painted
- Have a new phone system installed
- Have up-to-date wiring installed to provide possibilities for expansion of technology and

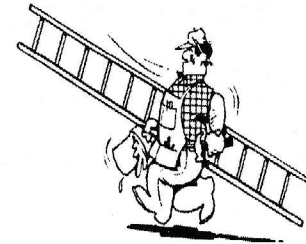

wireless capabilities

- Have diagnostic work done on the networking of the computers in the downstairs computer lab

Funds for these projects are outside of our regular operating budget and come from special gifts and memorial money. Work on the above projects is expected to be complete by January 5.

Emmaus Ends 2012 in the Black

Thanks to strong giving the last quarter of the year, it has been possible to pay all bills due by year's end as well as to fulfill our commitment for benevolence giving to the greater church. The council



will present a year-end report and make recommendations for 2013 at the January 27 annual meeting. Thank you for sharing of your resources to help support the ministry of Emmaus!

Annual Reports Are Due in January

In order to present the full report to the congregation a week before the January 27 annual meeting, the office would like reports turned in by January 14. Reports may be submitted on paper, on computer disk, or by e-mail. If



Annual Church Meeting

you submit a report by e-mail, it works best to have the report in the text of the e-mail in case there is any difficulty opening the report as an attached file.

FaithWorks Seeks Fleece for Youth Project

The next FaithWorks Youth event, at St. Andrew Lutheran Church, 1015 Four Mile Road, at 6:30 p.m. January 4, will be a community-wide service project as well as a Youth Lock-In for grades 6-12. The members of each church as well as the community are invited to help make fleece blankets to be distributed throughout organizations in Racine. But we need fleece.



If you have any extra fleece around the house, please think about donating. Or, if you see a sale at the hobby store, think of us. Please contact Amanda McTavish at 608-807-8066 if you have any questions or for donations.

Find FaithWorks on line at <http://faithworksracine.wordpress.com>

Participate in Souper Bowl of Caring February 2-3

The Super Bowl takes place on Sunday, February 3, and approximately 100 million Americans are expected to tune in to watch. As many are enjoying abundant food and friendship while hosting or attending parties, approximately 1 billion people will be hungry.



The Souper Bowl of Caring is an ecumenical, youth-led movement, with more than 2,000 ELCA youth groups raising money for hunger-related charities each year.

At the February 2 and 3 worship services, drop a dollar in a soup pot as you leave worship. Your donation will go directly to the Northside Food Pantry right here in our community. With your help, more dollars will be raised, more lives will be changed, and more

young people will experience the joy of serving Christ by serving others.

Youth Birthdays

Jan. 1	Collin Cacciotti, 8
Jan. 1	Patrick Austin, 15
Jan. 4	Danna Trevino, 5
Jan. 5	Luis Tapia, Jr., 12
Jan. 9	Daniella Zavala, 4
Jan. 10	Abbigail Perez-Alvarez, 2
Jan. 10	Rylee Brown, 11
Jan. 13	Madelyn Vash, 8
Jan. 20	Maraina Love, 3
Jan. 20	Odalys Tinaro, 11
Jan. 23	Ilyn Ruiz, 3
Jan. 25	Angel Mateo-Perez, 5
Jan. 26	Carina Saucedo, 4
Jan. 26	Leah Talbott, 5
Jan. 26	Carina Saucedo, 3
Jan. 28	Kaitlyn Sodke, 13
Jan. 29	Joshua Martinez, 18
Jan. 31	David Castañeda Jr., 5



Children Present Fun Christmas Pageant

It was no ordinary night. As people passed by on their way to Bethlehem for the census, a bunch of shepherds couldn't understand why no one would pay any attention to them. Reality check: They were just lowly shepherds watching a bunch of smelly sheep. Then an angel came and announced that a Savior was to be born and that they were to head down to Bethlehem to see this special baby boy.

Led by a cast of five shepherds (Jose Arroyo, Luis Faz, Bianca Ramirez, Lenice Arellano, and Alan Faz) and Mary and Joseph (Angela Aburto-Sanchez and Irving Ruiz) and a supportive choir of shepherds and sheep, the kids engaged the audience in a fun presentation of one aspect of the Christmas story.

A highlight was the group of sheep (Flavio, Melanie and Brianna Hernandez, Nizeth Arroyo, Selena Laura Ramirez and Nataly Contraras) and dressed in black

with floppy ears doing their interpretation of the song Stinky, Smelly Sheep. The rousing finale had all singing with lots of enthusiasm, Go and Tell; go and tell your friends and neighbors that Jesus Christ is born today!

Thanks to the sewing crew of Carol Eschmann, Kathy Christensen and Shirley Velzka for creating shepherd headdresses and sheep ears for our "black sheep." Kudos go to Brenda Trumbauer, the accompanist and Ryan Lamberton, soundman. Thanks Andrea for your "black sheep" routine. The staff (Katie, Courtney, Marco, Jose and Diane whose ongoing encouragement helped the kids learn the words and music - thank you!

The pageant can presently be seen on you tube on Art Smith's YouTube Page and on the Education page of Emmaus' web site, www.emmaus-racine.org/Educacn.html

Knitters Purl for Wadewitz Kids

Thanks to the busy hands of the folks of "Knit One, Purl One," many kids will have hats, mittens and scarves to keep them warm this winter. Your loyalty is appreciated: Thanks Bev Hansen, Lael Richter, Cathy Meyer, Sandi Strini and Diane Melander.

K1P1 meets on Mondays at 10:00 a.m. This group also creates prayer shawls and baptismal blankets. All who like working with your hands and enjoy a few laughs amidst quiet conversation are invited to join. To the knitters and sewers who joined forces to wrap

the Christmas gifts for the EASY kids: it was fun.

Knitters Regroup in January

The Knit One, Purl One group has been taking a break for Christmas and New Year's, but will resume their regular Monday morning sessions on January 7. Anyone who enjoys working with yarn and thread is invited to join them in the Fireside Room Mondays at 10:00 a.m.

Crunching the Numbers

Weekly worship attendance averages (calculated as of Dec. 24, 2012)

	2010				2011				2012		
	Sat	9:15	12:00	Wed	Sat	9:15	12:00	Wed	Sat	9:15	12:00
Dec	12	90	126	63	13	57	148	n/a	11	51	229
Adv.	108+364+182=654				78+376=454				156 + 207 = 363		
12/24	4:30		7:00		4:30		7:00		4:30		7:00
	130		86		125		89		96		284
	2011				2012						
Jan.	16	59	143	54	12	44	186	49			
Feb.	14	52	136	49	14	43	183	10			

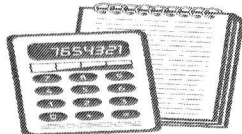

Financial Figures

Total for month Year to date

General Fund offerings received in November: \$ 10,031.43 }

Thanksgiving (to Food Pantry): 217.14 } \$135,663.42

Mortgage retirement offerings received in Nov. '12 \$120.00..... Campaign TD: \$71,572.62

Mortgage payments in Dec. '12: Principal \$824.39

Interest..... \$167.61

Total..... \$992.00

Principal balance as of December 14, 2012: \$32,148.99

January Worship Leaders

	Altar Guild	Communion Assts.	Readers	Ushers
Sat. Dec. 29 5:00 pm	Marge Zielke Amy Zielke	—		—
Sun. Dec. 30 9:15 am	Caren Lambertson	Karen Sedgwick	Chris Lambertson	Team 3
Sat. Jan. 5 5:00 pm	Barb & Jamie Toslek	—		—
Sun. Jan. 6 9:15 am	Joy Lippmann Marge Jensen	Kathy Christensen	Chris Lambertson	Team 1
Sat. Jan. 12 5:00 pm	Cheryl Dexter Shirley Irvine	—		—
Sun. Jan. 13 9:15 am	Barb Larsen Pat Jensen	Cindi Larsen Nancy Smith	John Knuteson	Team 2 Christensen
Sat. Jan. 19 5:00 pm	Judy Berndt Linda Meteyard	—		—
Sun. Jan. 20 9:15 am	Bev Hansen Audrey Villalobos	Shirley Velzka	Jim Larrabee	Team 4 Meteyard
Sat. Jan. 26 5:00 pm	Cathy Meyer Linda Clinton	—		—
Sun. Jan. 27 9:15 am	Kathy Christensen Marlyn Christensen	Karen Sedgwick Diane Melander	<i>tbd</i>	Team 5 Porcaro
Sat. Feb. 2 5:00 pm	Brian & Denise Keller	—		—
Sun. Feb. 3 9:15 am	Grace Falaschi	Chris Lambertson	Amy Haman	Team 1





Fellowship Hosts in January

January 13: Loren & Cindi Larsen

January 20: Maribel and children

Readings for January

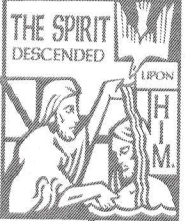
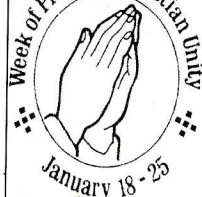
January 6:	Isaiah 60:1-6	Ephesians 3:1-12	Matthew 2:1-12
January 13:	Isaiah 43:1-7	Acts 8:14-17	Luke 3:15-17, 21-22
January 20:	Isaiah 62:1-5	1 Cor. 12:1-11	John 2:1-11
January 27:	Neh. 8:1-3, 5-6, 8-10	1 Cor. 12:12-31a	Luke 4:14-21
February 3:	Jeremiah 1:4-10	1 Cor. 13:1-13	Luke 4:21-30

Sunday	Monday	Tuesday	Wednesday	Thursday	Friday	Saturday
<p><i>January, 2013</i></p> <p>1925 Summit Avenue Racine, Wisconsin 53404 262-634-5515 Emmaus Evangelical Lutheran Church</p>		<p>1 NAME OF OUR LORD <i>Offices closed</i></p>	<p>2</p>	<p>3 11:00 am Sunday bulletin deadline 6:00 pm Ensayo de coro</p>	<p>4 6:30 pm FaithWorks youth service activity at St. Andrew LC</p>	<p>5 TWELFTH NIGHT 5:00 pm Worship service with Holy Communion (English)</p>
<i>Pastor Mary is away until January 4</i>						
<p>6 EPIPHANY 9:15 am Communion service (English) 10:30 am Coffee & conversation 10:30 am Blood pressure tests 12:00 m Santa misa (español) 12:30 pm Kids' Camp (bilingual)</p>	<p>7 10:00 am Knit 1, Purl 1 3:00 pm EASY</p>	<p>8 1:30 pm Clergy meeting 3:00 pm EASY 5:00 pm GED class 5:30 pm TOPS</p>	<p>9 1:30 pm Women's Bible study 3:00 pm EASY 5:30 pm Supper 5:30 pm Clases (español) 6:15 pm Kids' religious ed. 6:15 pm Adult English class</p>	<p>10 11:00 am Sunday bulletin deadline 3:00 pm EASY 4:00 pm BENNU legal appointments 6:00 pm Ensayo de coro 6:00 pm GED class</p>	<p>11</p> 	<p>12 10:00 am Clase de 1ª comuni6n 5:00 pm Worship service with Holy Communion (English)</p>
<p>13 BAPTISM OF OUR LORD; ST. KNUT 9:15 am Communion service (English) 10:30 am Coffee & fellowship 12:00 m Santa Misa (español) 12:30 pm Kids' Camp (bilingual)</p> 	<p>14 Annual reports due 10:00 am Knit 1, Purl 1 3:00 pm EASY 6:30 pm Worship & music committee</p>	<p>15 Feb. <i>Visitor</i> articles due 3:00 pm EASY 5:00 pm GED class 5:30 pm TOPS</p>	<p>16 3:00 pm EASY 5:30 pm Supper 5:30 pm Clases (español) 6:15 pm Kids' religious ed. 6:15 pm Adult English class</p>	<p>17 11:00 am Sunday bulletin deadline 3:00 pm EASY 6:00 pm Ensayo de coro 6:00 pm GED class</p>	<p>18 CONFESSION OF ST. PETER</p> 	<p>19 5:00 pm Worship service with Holy Communion (English)</p>
<i>Solutions for Success classes, 8:30 a.m. to 3:00 p.m.</i>						
<p>20 2ND SUNDAY AFTER EPIPHANY; DAY OF PRAYER FOR PEACE IN MIDDLE EAST 8:30 am Musicians' rehearsal (English) 9:15 am Chicago Folk Service (English) 10:30 am Coffee & fellowship 12:00 m Santa misa (español) 12:30 pm Kids' Camp (bilingual)</p>	<p>21 MARTIN LUTHER KING DAY 10:00 am Knit 1, Purl 1</p> 	<p>22 5:30 pm TOPS 6:00 pm GED class 6:30 pm Church council</p>	<p>23 3:00 pm EASY 5:30 pm Supper 5:30 pm Clases (español) 6:15 pm Kids' religious ed. 6:15 pm Adult English class</p>	<p>24 ST. TIMOTHY 11:00 am Sunday bulletin deadline 3:00 pm EASY 4:00 pm BENNU legal appointments 6:00 pm Ensayo de coro 6:00 pm GED class</p>	<p>25 CONVERSION OF ST. PAUL</p>	<p>26 ST. TITUS 5:00 pm Worship service with Holy Communion (English)</p>
<p>27 3RD SUNDAY AFTER EPIPHANY; LYDIA, DORCAS & PHOEBE 9:15 am Communion service (English) 10:30 am Annual meeting of the congregation (English) 12:00 m Santa Misa (español) 12:30 pm Kids' Camp (bilingual)</p>	<p>28 10:00 am Knit 1, Purl 1</p>	<p>29 8:30 am WCATY 5:30 pm TOPS 6:00 pm GED class 7:00 pm Fireside Exchange</p>	<p>30 3:00 pm EASY 5:30 pm Supper 5:30 pm Clases (español) 6:15 pm Kids' religious ed. 6:15 pm Adult English class</p>	<p>31 11:00 am Sunday bulletin deadline 3:00 pm EASY 6:00 pm Ensayo de coro 6:00 pm GED class</p>	<p>February 1</p>	<p>2 PRESENTATION OF OUR LORD 10:00 am Mundo maravilloso 5:00 pm Worship service with Holy Communion</p>

Keenagers in January

Keenagers will take the winter season off.



January Birthdays: 70 Years and Better

Jan. 6	Carol Perce	5311 Douglas Ave. # 202	53402
Jan. 7	Harold Miller	2704 James Avenue	53403
Jan. 29	Jan Bertram	1400 Eighth Avenue, Union Grove	53182

Winter Envelopes Will Be in Narthex

As we continue efforts to control expenses, the next set of offering envelopes will be made available for members to pick up in the narthex. We will mail envelopes to shut-ins and distant members who wish to have them, but at over \$1 in postage per set, we try to mail out as few of them as we possibly can.

Members who use electronic funds transfers (EFTs) to make their offering contributions will not receive offering envelopes. We are also trying to cut costs by not ordering offering envelopes for members who tend not to use them.

We will have some blank sets

on hand for new or reactivated contributors, however.

If you are interested in arranging EFTs to Emmaus, click on the green "Electronic Fund Giving" button on our web site, www.emmaus-racine.org, or our blog, emmaus.wordpress.com. Or fill out the form on Page 13 and give it to Paul in the office. You can arrange one-time or recurring gifts to Emmaus on a secure web site, either from your checking account or on your credit card. (Emmaus is charged a small percentage of credit card transactions.)

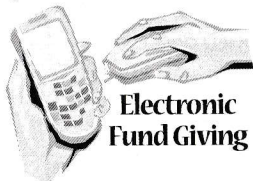

Emmaus to Serve Community Meal February 7

It's Emmaus' turn to serve at St. Patrick's Community Meal Site on February 7. Please sign up in the narthex to help serve, or to provide a casserole, jello, or dessert. 9"x13" pans are available in the kitchen off

the Sunset Room.

Whether you bring your own container or borrow a pan from church, please tape your name to it so that it gets returned.

Generous Hearts Help Giving Tree

Your gifts to the Giving Tree meant that the EASY kids all received an educational game and books. Thank you! The Knit One

Purl One and sewing groups took a morning to play Santa's elves to wrap the gifts and celebrated the season with a potluck lunch.

Food Pantry Hires New Director

By Rev. Rosalind Dryver-Scott

We hope that each of you had a very blessed Thanksgiving and found much to be thankful for. We now prepare our spirits and minds in this Advent to once again receive the gift of Christ at Christmas and to renew our hope in the coming Kingdom of God.

The purpose of my letter is to thank you for your continued support of the North Side Food Pantry and to announce good news as we head into the year 2013. We were able to find a director/coordinator for the Food Pantry. Her

name is Jamie Singleton. She will be assisted by her family in the day-to-day management level operations. She of course will still need your participation and support.

Emmaus Northside Food Pantry Volunteers

Trinity United Methodist Church
3825 Erie Street
1:30 p.m. to 4:00 p.m.

January 24: Cheryl Dexter, James Larrabee, Marge Zielke, Diane Melander

February 28: Boots LeRoux, Pat & Ron Jensen, James Larrabee

If you are unable to work your scheduled date, please trade with someone on the schedule. Please do not call Cindi to find someone. Also, please do not leave only two people on duty.

Thank you for your support of this important ministry.



Memorials & Honoraria

Non-designated memorials:

In memory of Isabelle Barry: \$25.00

In memory of Helmie Wosilait: \$50.00

Every Litter Bit Hurts

by John Berge

Litter is a problem around the world; Southeast Wisconsin is no exception. There are volunteers from various organizations that "Adopt-A-Highway" and pick up bags of trash three times a year. Yet in a couple of days or even less, someone will have littered that section of highway.

I once sent the local paper two pictures, one of a waste basket and the other a car window. I asked the editor to print the two pictures side by side in the hopes that people might learn the difference.



"Letters to the editor do not include pictures," came back the reply.

And yet, how simple it would be to eliminate the litter problem if each person would be more careful ... if they made sure that they did not litter in any way.

Litter in our area is not a severe health problem nor does it seriously affect our food resources, but in the oceans it is much more serious. The coasts of Alaska, Hawaii, British Columbia and other areas on the Pacific Coast are now receiving the first debris (after a while it is no longer "litter") from the earthquake and tsunami that

devastated Japan. This trash definitely does affect people's health and safety and that of other creatures in and around the sea, many of which are directly or indirectly part of our food chain.

How well do the salmon grow with their stomachs full of polystyrene foam? How well can the Alaskan crabs forage for food with their claws entangled in fish lines or wire? How well can a young sea turtle swim with its head trapped in the plastic from a six pack?

Scientists from the Ocean Conservancy and elsewhere are trying to determine whether the trash is from the tsunami or not, but first

indications are that the vast majority is not from any tsunami but from careless loss or dumping of waste by people.

Here in southeast Wisconsin, it may be just an eyesore, but when our trash gets blown or washed into the lakes, rivers and streams it becomes a health, safety, food issue ... an environmental stewardship issue.

Remember, the water and the trash in virtually every river and stream in the world eventually ends up in big lakes and the oceans where it does real harm to God's creatures and creation.

AUTHORIZATION FORM

The Simply Giving Program
endorsed by
Thrivent Financial Bank

FOR OFFICE USE ONLY		ENVELOPE/DONOR #	DATE
Emmaus Evangelical Lutheran Church		504744303	
Effective date of authorization: ____/____/____			
Type of Authorization Form: <input type="checkbox"/> New Authorization <input type="checkbox"/> Change banking information <input type="checkbox"/> Change donation amount <input type="checkbox"/> Discontinue electronic donation <input type="checkbox"/> Change donation date			
Last Name		First Name	
Address			
City		State	Zip
Email Address			
FIRST DONATION DATE: ____/____/____	FREQUENCY OF DONATION: <input type="checkbox"/> Weekly on _____ <input type="checkbox"/> Monthly on _____ <input type="checkbox"/> Semi-Monthly (transferred on 1 st and 15 th of each month)	FUNDS AND AMOUNTS: <input type="checkbox"/> General Operating \$ _____ <input type="checkbox"/> Debt Retirement \$ _____ <input type="checkbox"/> Memorials _____ \$ _____ <input type="checkbox"/> Outreach _____ \$ _____ <input type="checkbox"/> Neighborhood Camp \$ _____ <input type="checkbox"/> Other _____ \$ _____	
CHECKING / SAVINGS	Please debit my donation from my (check one): <input type="checkbox"/> Savings Account (contact your financial institution for Routing #) <input type="checkbox"/> Checking Account (attach a voided check below)		Routing Number: _____ Valid Routing # must start with 0, 1, 2, or 3
			Account Number: _____ 1234567890 123 4567890001 Routing Number Account Number Check Number
I authorize the above church to process debit entries to my account. I understand that this authority will remain in effect until I provide reasonable notification to terminate the authorization.			
Authorized Signature: _____		Date: _____	
CREDIT CARD	Please charge my payments to my (check one): <input type="checkbox"/> Visa <input type="checkbox"/> MasterCard <input type="checkbox"/> American Express <input type="checkbox"/> Discover Card		
	Credit Card Number: _____		Expiration Date: _____
	Name on Card: _____		
	Billing Address (if different from above): _____		
I authorize the above church to charge my credit card in accordance with the information above.			
Signature (as it appears on the credit card): _____		Date: _____	

Harmony Club Welcomes Volunteers

By Stephanie Schreiner

Make friends for a lifetime by volunteering at Harmony Club. Held at different sites throughout Racine County, Harmony Club is a unique social program that provides quality care as well as companionship,



socialization and activities for older adults.

Volunteers are needed to help from 10:00 a.m. to 2:00 p.m. with crafts, lunch and playing games. Contact Stephanie Schreiner at sschreiner@llor.org or (262) 898-2731 to learn more.

Elsewhere in Our Area

Norwegian Lutheran Serves Lutefisk, Meatballs

Norway Evangelical Lutheran Church, 6321 Heg Park Road in Wind Lake, invites you to reserve your seat at their annual Norwegian lutefisk and meatball dinner on Saturday, February 9. Servings are at 11:30 a.m., 1:30 p.m. and 4:00 p.m. and include side dishes, beverages, cakes and ethnic pastries.

Call Joanne Jacobson at 262 534-6867 or Donna Hanson at 262 534-3862. Tickets are \$17.50 for adults, \$7.50 for children under 10 (free for children able to fit in a high chair), or \$16.00 is offered for seniors.

Crossroads Holds Anti-Racism Workshop

Crossroads Anti-Racism Organization invites you to
Emmaus Visitor * January, 2013 * Page M

"Understanding and Analyzing Systemic Racism," a three-day workshop, January 17-19, 2013, Thursday (5:00 to 9:00 p.m.); Friday (8:30 a.m. to 6:00 p.m.); Saturday 8:30 am to 4:00 p.m.) at Lutherdale Ministries, N7891 US Hwy 12, Elkhorn, WI 53121. Cost is \$125 for ELCA participants (\$150 with overnight dorm stay, bring own bedding), or \$175 for non-ELCA participants (\$200 with above Lutherdale accommodations). Cost includes materials and food. Scholarship assistance available upon request. To receive more details or if you have questions, please contact the following of the Greater Milwaukee synod's Anti-Racism Team: Mr. Jerry Key 414-465-0352 or keyju@match.edu, or Rev. Chuck Ruehle 262-886-3286 or chuck.ruehle@yahoo.com

Pastor Mary's Page

Called to Serve

Shuffling through my bills, Christmas cards and junk mail recently, an official looking envelope caught my eye. After opening it, my first response was, "Oh, no, why me?" My number had come up in the lottery of those called to serve on jury duty. The directions were clear: be available the week of January 21. Call in the night before to see if you must report in person Monday morning. There was a form to fill out, and information on parking was provided.

It's so easy to respond as I first did—I'm too busy; why me? But, I then stopped and asked, "Why not me?" There are so few times when we are directly called to serve to help our democratic system function as intended, and I should count it a privilege rather than a burden to do my part.

So often the invitations we receive to serve our community or our church are much more subtle. We don't typically receive mandates such as "Show up, or you will be fined \$500." But, when I reflect on

Jesus' words, "follow me," I hear both an invitation and a mandate. And when we hear those two great commandments, to love God and to love one another, those words are a privilege when received with an open heart.

We are called to love our God and our neighbors day in and day out. It's not just a short-term call, like that of jury duty, where we do our duty for a week and then check that off our to-do list.

How are we, as people of faith, going to respond for the long haul? Will we continue to serve and worship way into the future, even when, no doubt, the church as we know it today will change?

We know one thing for sure—God is faithful, all the time—and because of that, we are able to make a long-term commitment, trusting that God will lead the way.

Grateful that God lights our way,

Pastor Mary

IN THE JANUARY VISITOR:

- * *Annual Meeting*
- * *2012 Ends in Black*
- * *FaithWorks Seeks
Fleece*
- * *Souper Bowl of
Caring*
- * *Kids' Pageant Thanks*
- * *Knitters & Purlers*
- * *Envelopes Arrive Soon*
- * *New Food Pantry
Director*
- * *Every Litter Bit Hurts*
- * *Volunteer at Harmony
Club*
- * *Called to Serve*

Emmaus Evangelical Lutheran Church
1925 Summit Avenue
Racine, Wisconsin 53404-2374

Change service requested

Non-Profit Org.
U.S. Postage PAID
Racine, WI
Permit No. 137

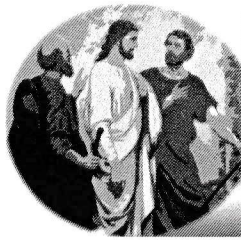

Emmaus Visitor

February, 2013

FaithWorks Congregations Host 'Our Stories, The Story: Lenten Pilgrimage'

The five congregations of FaithWorks Racine ELCA are trying something new with midweek worship services during Lent. Members of our congregations are invited to come to one worship service at each of the five Wednesdays from February 20 to March 20.



St. Andrew Lutheran Church, 1015 Four Mile Road, will host the February 20 worship service.

Lutheran Church of the Redeemer, 2417 Drexel Avenue, will host the February 27 service. Musicians from Redeemer and Atonement will lead Marty Haugen's "Holden Evening Prayer Service," and Pastor Elias Nasari

will share his story as a pastor/missionary from Tanzania called to serve in the U.S.

The Ascension Mime group will present their version of the Passion story at Atonement Lutheran Church, 2915 Wright Avenue, on March 6. For eighteen years, the Ascension Lutheran Church Youth of Waukesha have shared the passion story of Christ. After six weeks of rehearsal, they share it with a different church each Wednesday and Sunday during Lent. The entire cast is made up youth in grades 9 through 12.

Our Savior's Lutheran Church, 2219 Washington Avenue, hosts the worship service on March 13. Milwaukee native Arno Michaelis

➔ *Please turn to Page 3*

Emmaus Evangelical Lutheran Church
"Sent Forth by God's Blessing"
e-mail: emmausracine@sbcglobal.net
<http://www.emmaus-racine.org>

1925 Summit Avenue
Racine, Wisconsin 53404
Phone: 262 634-5515
Fax 262 634-0835

Pastoral Acts

Funeral:

Jesus Vargas Rodriguez
January 5, 2013

Jesus Vargas passed away December 28 at the age of 39. Jesus was a resident of Kenosha, where he was a cook with the Hillcrest Restaurant. He is mourned by his wife, Maribel, and their children, Stephanie and Joseph.

We Extend Our Sympathy and Prayers

Please remember the family of Rick Haman's mother, Caroline Haman, in your prayers. Mrs. Haman passed away January 11 in Rochester, Minnesota.

We extend our condolences to the family of Mariam Bacon, whose

funeral was January 15 at Sturino Funeral Home.

Al Svendsen's brother Ruben passed away in Minnesota January 21 at age 92; a celebration of his life was held at Lutheran Church of the Resurrection January 26.

Lent Begins February 13

Lent begins on Ash Wednesday, February 13. Pastor Mary will preach at the noon worship service.

After a 6:00 p.m. dinner, Emmaus will have a bilingual Ash Wednesday service at 7:00

including the imposition of ashes and communion.

In preparation for Ash Wednesday, our middle school kids burned their written confessions together with last year's palm branches.

Lenten Offerings for Outreach Encouraged

Outreach For Hope, the arm of our synod that provides funding for our outreach ministry at Emmaus, as well as generous support for Neighborhood Camp, is again offering the opportunity to help to support ministry to and with people in poverty. During this Lenten season, we are encouraged to give \$1.00 a day for

40 days. Remember others as you generously share, filling Lenten banks or envelopes as you are able. You decide what daily amount is right for you—50 cents, a dollar, or even five dollars a day. Your gift directly touches lives right here in our synod! Thank you for your generosity!

Contribute to 'Noisy Offering' on Souper Bowl Sunday

The Souper Bowl of Caring, led by youth of Emmaus and from churches all over the nation, is planned to help put God's love in action, providing care for those who are hungry and hurting.



Bring your change for a "noisy offering" on February 2 and 3. Every coin (and any paper money, too) dropped in the soup kettle will go toward relief efforts for world hunger. All contributions will go to the Northside Food Pantry.

Lenten Pilgrimage

↳ Continued from page 1

III, former white supremacist and author of *My Life After Hate*, will share his compelling story.

Emmaus will present The Prayer Walk of the Passion on March 20.

Services are all at 7:00 p.m. Dinner is served at 6:00

with the hosting congregation sharing their story of mission and ministry during the dinner hour.

Need a ride? Call the church office so that prior arrangements can be made.

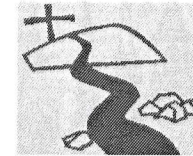

Emmaus Staff & Worship Times

Church: 1925 Summit Avenue, Racine, Wisconsin 53404-2374.

emmausracine@sbcglobal.net ☎ 262 634-5515

Pastors: Rev. Mary L. Janz 1530 S. Main St. 53403 mljanz@aol.com ext. 201
Jhon Freddy Correa 1909 Summit. jhoncorrea@hotmail.com ext. 202

Council President: Chris Lamberton

Church office: Paul Berge emmausracine@sbcglobal.net ext. 200

Education Coord.: Nancy Smith nnsdaisy@aol.com ext. 203

Director Outreach: Liliana Moncada moncada_liliana@hotmail.com ext. 204

Accompanist: Brenda Trumbauer Custodians: Rich Benson, Antelmo Hernando

English language services are held at Emmaus every Saturday evening at 5:00, and Sunday mornings at 9:15. Spanish language worship services are offered Sundays at noon. Ash Wednesday worship services on February 13 are offered at noon and 7:00 p.m.

Emmaus office hours are 9:00 a.m. to 3:00 p.m. Monday through Friday.

The VISITOR is published monthly September to July. The deadline for the March VISITOR is February 15. Submit articles to Paul Berge's attention by mail or by e-mail.

Emmaus Visitor

Vol. 41, No. 6

February, 2013

Can You Help Brighten Someone's Day?

The Member Care group could use extra help at this time. We need people to visit shut-ins, to write cards for special occasions, maybe just to make a



phone call or to offer a prayer.

If you could spare even an hour each month, we would appreciate any time you could share to provide care to other Emmaus members. Please contact Cathy Meyer (321-0050) if you would like to get involved.

Pastors Study Best Practices of Partnerships

What are other congregations doing nationwide as they also work on collaboration, partnerships and/or mergers for the sake of mission? Pastor Mary and Pastors Dana O'Brien and Ron Ballew have been named by the FaithWorks Mission Council to interview and study some of the best practices that have driven other partnerships among



congregations throughout the country.

Sandy Chrostowski of the synod staff and Dave Daubert, representing the ELCA staff in Chicago, are pointing to some cities where similar endeavors to strengthen ministry together are currently taking place. Phone interviews and possible site visits are a part of the information gathering process.

Bible Readings in February

- February 3: Jeremiah 1:4-10; Psalm 71:1-6; 1 Corinthians 13:1-13; Luke 4:21-30.
- February 10: Exodus 34:29-35; Psalm 99; 2 Corinthians 3:12-4:2; Luke 9:28-36 or 43a.
- February 13: Joel 2:1-2, 12-17 or Isaiah 58:1-12; Psalm 51:1-17 or Psalm 103:8-14; 2 Corinthians 5:20b-6:10; Matthew 6:1-6, 16-21.
- February 17: Deuteronomy 26:1-11; Psalm 91:1-2, 9-16; Romans 10:8b-13, Luke 4:1-13.
- February 24: Genesis 15:1-12, 17-18; Psalm 27; Philippians 3:17-4:1; Luke 13:31-35.

Emmaus Team Needed for Building Assessment

Each of the FaithWorks congregations will need to be represented by three to four people on Saturday, February 16 for a day for an assessment of our buildings. This is a full-day commitment, which will begin with an orientation led by Pat Dever of the Mission Investment Fund.

After that orientation, the group will tour four of the five buildings (Lutheran Church of the Redeemer has already taken part in such an assessment), with both

written and videoed documentation being recorded throughout the day. The group will then assimilate the information and pass it on to the respective Design/ Discernment Teams of each congregation for their work in the spring.

Please contact Pastor Mary (262-893-1317 or mljanz@aol.com) if you would like further information and/or might consider making this one-day commitment.

Tech Infrastructure, New Telephone System Installed

Hundreds of feet of cables are now in place following the recent wiring job completed throughout the entire Emmaus building. This allows us to connect directly phones, computers and other technology in areas previously not wired for those possibilities. The computer lab has been serviced, and it is now possible for the students using it to connect to the Internet without the previous difficulties.

WiFi is now available throughout the building, and those using laptop computers and tablets can access the wireless network through the use of the password that is available from any of the staff members.

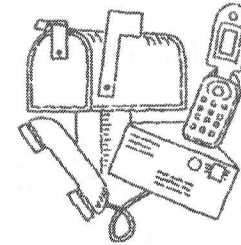

In addition to the new infrastructure for technology, a new phone system has been installed. The myriad of options for messages and forwarding calls are still being learned, and the system continues to be tweaked by those who installed it.

Now, rather than the large PBX box on the lower level, there is a smaller box that is part of the overall system. Our phone carrier has also been changed, meaning both a monthly monetary savings and faster Internet connection time.

These technical updates were made possible through memorial and special designated gifts for technology.

Katie Syslack Says Good-bye to EASY

Katie Syslack, Carthage education grad who is Bev Hansen's granddaughter, began a full-time teaching position with Milwaukee Public Schools January 14. After spending 1½ years as an assistant teacher in the EASY program, Katie realized that it wasn't "easy" to say good-bye to all the students she had grown to know and love in the after school program. She did assure Nancy



Smith that she hoped to return in June to again be part of the Neighborhood Camp staff. We wish Katie all the best in her new endeavors!

Youth Birthdays in February

- Feb. 5 Jordan Gallagher, 14
- Feb. 6 Trista Meteyard, 7
- Feb. 8 Ismael Saldivar, 9
- Feb. 13 Alicea Castulo, 14
- Feb. 15 Rose Rubio, 1
- Feb. 27 Carol Saldivar, 10
- Feb. 27 Alex Maryland, 18

Emmaus to Host WCATY

Emmaus will open our doors to the Wisconsin Center for Academically Talented Youth (WCATY) on Tuesday, February 26; and Tuesday, March 26. WCATY will conduct classes for academically talented middle schoolers from the area.



WCATY will offer four online courses for these gifted, talented, and high achieving students. A part of the coursework includes the opportunity to meet together

with their instructors and their classmates in face to face meetings.

Cindi Larsen, Gifted and Talented Coordinator for RUSD, has worked with David Metzger at McKinley and the other middle school counselors to arrange the classes for this year. RUSD would like to express its thanks for the cooperation of Emmaus in permitting us the use of the church facility. The face to face meetings will be conducted from 9:30 a.m. to 1:30 p.m.

Renew Your Pledge for 2013 Now

By Carolyn Wooster

Another year already and there is still time to renew your pledge for 2013. Thank you for your generous support last year.



If you haven't already done so, we are encouraging your support again this year to help fund Emmaus' budget and our very successful outreach programs. We need your pledge to help plan our finances for 2013.

You can fill out a pledge card or choose on-line giving. To

implement on-line giving fill out the authorization form on page 14 or visit the Emmaus web site and click on on-line giving (<http://emmaus-racine.org>). If you have any questions, please call Paul at 634-5515.

Council to Meet After Service

The Emmaus church council will meet at 10:45 a.m. Sunday, February 10.

Memorials & Honoraria

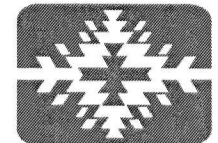

Non-designated memorials:

In memory of Isabelle Barry: \$180.00

Crunching the Numbers

Weekly worship attendance averages (calculated as of Jan. 20, 2013)

	2011				2012			2013			
	Sat	Sun	Dom	Wed	Sat	Sun	Dom	Sat	Sun	Dom	
Jan	16	59	143	54	13	49	180	12	37	178	
Feb	14	52	136	49	14	43	183				
Mar	14	60	167	45	17	46	189				
ASH	English: 10		Spanish: 226		Noon: 13		7:00: 200				

Financial Figures

Total for month **2012 to date**
 Gen'l Fund offerings received in Dec. '12: \$ 18,695.00 }
 Initial, Xmas, Sustainability, corporate: 951.00 } \$155,309.42

Mortgage retirement offerings received in Dec. '12	\$160.00.....	Campaign TD: \$71,732.62
Mortgage payments in Jan., 2013: Principal	\$832.79	
Interest.....	\$159.21	
Total.....	\$992.00	
Principal balance as of January 14, 2013: \$31,320.41		Emmaus Visitor ♥ Page 7

Lydia Circle Meets Again in March

Because the regularly scheduled Bible study would fall on Ash Wednesday, the women of

the Lydia Circle decided to forgo their February meeting. The next study will be March 13 at 1:30 p.m.

Emmaus to Serve Community Meal February 7

It's Emmaus' turn to serve at St. Patrick's Community Meal Site on February 7. Please sign up in the narthex to help serve, or to provide a casserole, jello, or dessert. 9"x13" pans are available in the kitchen off the Sunset Room.

A recipe for the casserole is posted on line at www.emmaus-racine.org/SociConc.html.

You may bring your own container or borrow a pan from church. Either way, please tape your name to the pan so that it gets returned.

Thanks to Food Pantry Volunteers

by Cindi Larsen, Northside Food Pantry Co-Director

Loren and I would first like to express our sincere thanks to the many Emmaus volunteers who assisted us with the two monthly deliveries: Cheryl Dexter, Audrey, Ashley, and Alex Villalobos, Sarah Dexter, Ron and Pat Jensen, Deb Albright, Diane Melander, Linda Meteyard, Karen Sedgwick, Marge Zielke, and Kathy and Rich Christensen.

The volunteers who work throughout the year on the fourth Thursday of the month are Jim and Mary Larrabee, Cheryl Dexter, Marge Zielke, Diane Melander, Boots LeRoux, Pat and Ron Jensen, June Beck, Kathy and Rich

Christensen, and Karen Sedgwick. New to this year's list of volunteers will be Art Smith. We will remain involved as volunteers ourselves on Pantry days.



FOOD SHELF

Emmaus is so blessed to have such willing volunteers to give of themselves in serving in this important ministry.

Thank you to the Emmaus family for your support in so many ways of the Northside Food Pantry.

Volunteer Schedule

February 28: Boots LeRoux, Pat and Ron Jensen, James Larrabee
 March 28: June Beck, James Larrabee, Cheryl Dexter, Cindi Larsen

February Worship Leaders

	Altar Guild	Communion Assts.	Readers	Ushers
Sat. Feb. 2 5:00 pm	Brian & Denise Keller	—	—	—
Sun. Feb. 3 9:15 am	Grace Falaschi	Chris Lamberton	Amy Haman	Team 1
Sat. Feb. 9 5:00 pm	Marge & Amy Zielke, Missy P.	—	—	—
Sun. Feb. 10 9:15 am	Caren Lamberton	Pat Jensen Joy Lippmann	Ron Jensen	Team 2 Christensen
Wed. Feb. 13 Noon / 7 pm	Pat Jensen / Barb Larsen			/ Team 3
Sat. Feb. 16 5:00 pm	Barb & Jamie Tosiek	—	—	—
Sun. Feb. 17 9:15 am	Joy Lippmann Marge Jensen	Cindi Larsen	Cindi Larsen	Team 4 Meteyard
Sat. Feb. 23 5:00 pm	Cheryl Dexter Shirley Irvine	—	—	—
Sun. Feb. 24 9:15 am	Kathy Christensen Marlyn Christensen	Chris Lamberton Diane Melander	Jenn Haman	Team 5 Porcaro
Sat. Mar. 2 5:00 pm	Judy Berndt Linda Meteyard	—	—	—
Sun. Mar. 3 9:15 am	Bev Hansen Audrey Villalobos	Pat Jensen	Melissa Lemke	Team 1

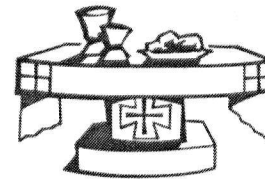





Fellowship Hosts in February:

February 3: Marge, Amy and Missy
 February 10: Carolyn & Dan Wooster
 February 17 and 24: open

Keenagers are taking the winter off.

February Birthdays: 70 Years and Better

Feb. 1	Carol Saylor	4511 Harvest Lane	53402
Feb. 2	Pat Torine	2621 Donna Avenue	53404
Feb. 2	Hedy Wagner	4508 N. Green Bay Road	53404
Feb. 10	Alfred Thomsen	3296 Backridge Rd., Woodlawn TN	37191
Feb. 14	Bernice Holding	401 Center St., Birnamwood WI	54414
Feb. 20	John Demant	8600 Corporate Dr., #1	53406
Feb. 21	Constance Bertermann	135 Avie Ct., Brookfield, WI	53045

Sunday	Monday	Tuesday	Wednesday	Thursday	Friday	Saturday
			Emmaus Evangelical Lutheran Church 1925 Summit Avenue, Racine Wis. http://www.emmaus-racine.org emmausracine@sbcglobal.net 262 634-5515		1 	2 PRESENTATION OF OUR LORD 10:00 am Clase de 1a comunión 5:00 pm Worship service with Holy Communion
			Jan. 31 7:00 pm P. Devine Funeral, Purath-Strnd			
3 4 TH SUNDAY AFTER EPIPHANY; ST. ANSGAR 9:15 am Worship service with Holy Communion (English) 10:30 am Coffee & fellowship 12:00 d Santa misa (español) 12:30 pm Kids' Camp (bilingual)	4 10:00 am Knit One, Purl One 3:00 pm EASY	5 3:00 pm EASY 5:00 pm TOPS 6:00 pm GED class	6 3:00 pm EASY 5:30 pm Supper 5:30 pm Clases (español) 6:15 pm Kids' religious ed 6:15 pm Adult English class	7 11:00 am Sunday bulletin deadline 3:00 pm EASY 4:00 pm BENNU legal consultation 6:00 pm Ensayo de coro 6:00 pm GED class	8	9 10:00 am Clase de 1ª comunión 5:00 pm Worship service with Holy Communion
10 TRANSFIGURATION OF OUR LORD 9:15 am Worship service with Holy Communion (English) 10:30 am Coffee & fellowship 10:45 am Church council meeting 12:00 d Santa misa (español) 12:15 pm Guitar lessons 12:30 pm Kids' Camp (bilingual)	11 10:00 am Knit One, Purl One 3:00 pm EASY	12 SHROVE TUESDAY 3:00 pm EASY 5:00 pm TOPS 6:00 pm GED class	13 ASH WEDNESDAY 12:00 noon Worship service 3:00 pm EASY 6:00 pm Supper 7:00 pm Worship service 	14 VALENTINES DAY 11:00 am Sunday bulletin deadline 3:00 pm EASY 6:00 pm Ensayo de coro 6:00 pm GED class	15	16 5:00 pm Worship service with Holy Communion
<i>Pastor Mary on vacation Feb. 15 – Mar. 8</i>						
17 1 ST SUNDAY IN LENT 9:15 am Chicago Folk service with Holy Communion 10:30 am Coffee & fellowship 12:00 d Santa misa (español) 12:15 pm Guitar lessons 12:30 pm Kids' Camp (bilingual)	18 PRESIDENTS' DAY 10:00 am Knit One, Purl One 3:00 pm EASY	19 <i>No Keenagers</i> 3:00 pm EASY 5:00 pm TOPS 6:00 pm GED class	20 DAY OF PRAYER FOR PEACE IN MIDDLE EAST 3:00 pm EASY 6:00 pm Dinner at St. Andrew LC 7:00 pm Lenten service at St. Andrew LC	21 11:00 am Sunday bulletin deadline 3:00 pm EASY 4:00 pm BENNU legal consultation 6:00 pm Ensayo de coro 6:00 pm GED class	22  CELEBRATE BLACK HISTORY	23 5:00 pm Worship service with Holy Communion
<i>Pastor Mary on vacation</i>						
24 2 ND SUNDAY IN LENT; ST. MATHIAS 9:15 am Worship service with Holy Communion 10:30 am Coffee & fellowship 12:00 d Santa misa (español) 12:30 pm Kids' Camp (bilingual)	25 10:00 am Knit One, Purl One 3:00 pm EASY	26 9:00 am WCATY 3:00 pm EASY 5:00 pm TOPS 6:00 pm GED class 7:00 pm Fireside Exchange	27 3:00 pm EASY 6:00 pm Dinner at LC of the Redeemer 7:00 pm Lenten service at LC of the Redeemer	28 11:00 am Bulletin deadline 3:00 pm EASY 6:00 pm Ensayo de coro 6:00 pm GED class	March 1	2 10:00 am Clase de 1a comunión 5:00 pm Worship service with Holy Communion
<i>Pastor Mary on vacation</i>						

Scrip Available After Services

Need an idea for a Valentine's Day gift? We have a variety of gift cards on hand, including various

restaurants, department stores, and specialty stores. Check out the Scrip table after worship services.

Offering Envelopes Are in Narthex

Our offering envelopes for February through May were ordered in December and are in alphabetical order in a tray in the narthex for members to pick up.

To trim costs, we have not ordered offering envelopes for members who generally give "loose" offerings or who contribute by electronic funds

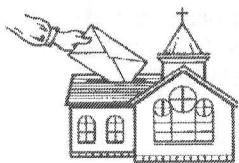

transfers. We also plan to mail only those envelopes assigned to members who are not able to attend church regularly; please give the church office a call if you would like your envelopes mailed or delivered to your home.

Thread By Thread Posts New Hours

Free clothes every first & third Wednesday! Bethania Lutheran Church, 4120 Wright Avenue, hosts Thread by Thread 11:00 a.m. to 1:30 p.m., 6:00 p.m. to 7:30 p.m.

Good clean clothes for the families who need them. They only request that, "you take what you need and need what you take." Please bring a canned good in exchange for the clothes.



This clothing ministry gladly accepts donations of clean clothes for kids. Boots, shoes, coats, hats, and gloves for all ages. Also gently used games, toys bedding and baby equipment. Tax donation statement available.

Donation Drop Off: Tuesday to Thursday 2:00 p.m. to 4:30 p.m. and Friday 10:00 a.m. to 2:00 p.m. or during store hours above. For pick up or to arrange for other drop off times or to volunteer- Please call 262.632.7267 or email Bethania@tds.net

Environmental Stewardship

Native Gardens Foster Biodiversity

by John Berge

As I write this column, it is in the middle of winter, the coldest temperatures of the year are expected in the next few days and gardening catalogues are arriving in the mail. We are more than fourteen inches behind "normal" in snowfall; southern Wisconsin is under drought conditions, more than a foot behind in total precipitation in the last year and a half, resulting in dry soils, lower lakes, rivers and streams and plants are under stress.

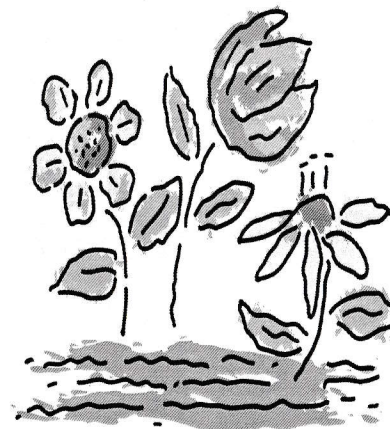

Those are conditions that should lead us to considering and fostering more sustainable gardens and yards for both now and the long term. The thirty-year temperature averages (referred to as "normal" in the paper and on TV), now calculated over a more recent time period (1981-2010) are 0.5 degrees higher than the previous tri-decade. Gardens and yards planted with native species, rather than the imported and hybrid species most of us are used to, have deeper roots and so require less water, fertilizer and pesticides. In fact, reduced use of

pesticides mean that more insects and other organisms are in balance with the native plants and so are available to feed the birds that many of us enjoy watching in our yards, parks and neighborhoods.

Now is the time to start planning to put at least a portion of your property into a more native garden. A monoculture such as an Iowa corn field or a Kentucky bluegrass lawn is the antithesis of the biodiverse community of a well-planned native planting.

There are a number of good books on native or natural gardening in libraries and book stores. Native plants and seeds are available from several natural garden suppliers and from groups like The Wild Ones and the University of Wisconsin Friends of the Arboretum plant sales in the spring. You do not need to suddenly redo the entire yard (although some will like the idea of a no-mow lawn), but you can start with a smaller area and see what works best for you, your soil and your location.

Diakonia Requests Your Prayers

Our Synod diakonia students need your prayers and support! As we enter this season after Epiphany and begin our journey toward Lent please remember those individuals who are studying this semester. Faithfully committed to seeking something greater than themselves, diakonia students are working toward equipping the baptized saints for ministry and



raising themselves to a higher call within their churches and their communities. diakonia offers time for discernment and devotion to this call. If you have a student or graduate in your congregation, please take a second to thank them and encourage them to complete this brilliant and worthwhile program!

Someone Needs Gentle Worship

Someone you know needs Gentle Worship. The couple who has been married 50 years, and one of them now has dementia... The family who has a child with autism... The single mother with a boy who just can't sit still... The man who relies on his service dog to get around...



for folks with disabilities or special needs. Please spread the word to those that you know who may not feel comfortable in a typical Sunday church service, but hunger for a chance to be part of a worshiping congregation!

Their next service is Saturday, February 2 at 4:00 p.m. at Holy Communion Northwest Campus, 5040 Northwest Ave. (Better yet: why not offer to come with them?)

Mt. Pleasant Designates Lenten Offerings for Neighborhood Camp

At their annual congregational meeting the members of Mt. Pleasant Lutheran Church approved a budget that included designating their Lenten offerings for Neighborhood Camp and the Racine ELCA Cluster Meal Site. Pastor Mary and Diane Thygeson will attend one of the Lenten services to tell about the ministry of the summer Neighborhood Camp program.

Elsewhere in Our Area

Green Congregations Meet February 23

Racine Green Congregations took a sabbatical this fall. Thanks to Marilyn Kiemen's leadership, we had a steering committee meeting last week to plan for the late winter and spring.

Here is the information for our winter meeting: Saturday, February 23, 8:30 to 10:00 at Resurrection Lutheran Church. Program: Ross Astoria from the Citizens Climate Lobby will make a presentation about that group's efforts related to climate change.

The meeting always involves brief devotions to open and close, a short program, reports and conversation from the congregations, and refreshments. The steering committee includes Marilyn Kiemen, Adele Helmlé, Sister Janet Weyker, Betty Brenneman, Lynne Leithleiter, Jeff Sytsma, Diane Tetrault, and Dave Rhoads. Green Congregations are seeking more members to participate on the planning committee.

Green Teams to Bless HALO Men's TV Room

Congratulations! Resurrection Lutheran Church Green Team has redone four rooms at HALO in eco-friendly manner. The latest was the men's television room,

done with 80% recycled materials—chairs, bookcase, tables, lamps, and theater seats. It took more time to put theater seats together than the time spent on the other rooms.

To celebrate with clients of HALO, the Resurrection Lutheran Church Green Team would love to have people join them for the Blessing on February 2 (the day before Super Bowl) at 3:00 p.m. for the blessing of the newly-furnished television room. Light refreshments to follow.

HALO is located at 2000 DeKoven Avenue in Racine.

RIC Holds Breakfast

Love and Justice Breakfast – February 16, 2013 Racine Interfaith Coalition Love and Justice Breakfast Location: Christ Church-United Methodist 5109 Washington Avenue Racine, Wisconsin 53406 Breakfast Served Promptly at 8:00 a.m. Tickets \$12.00; Ages 5-12 \$ 5.00; Under 5 Free Please contact your representative of RIC or call the RIC Office for tickets. 262-635-9532 Present Community Awards... Clergy Bakery Auction....Bake Sale...

Called to Re-Imagine Our Future Together

By mid-February the Emmaus Design/Discernment Team for FaithWorks will be formed. Each congregation of FaithWorks is forming its own team to do the work of assessing the gifts and assets of all of the FaithWorks member congregations. Tours of the buildings and facilities are scheduled to take place on Saturday, Feb. 16 under the direction of Pat Dever of the ELCA Mission Investment Fund. Ms. Dever, who has national experience in the assessment of church properties, will guide the group as they assess the assets and liabilities of our current facilities.

Lenten pilgrimages and any additional information regarding ministry and mission to be prepared by each congregation will also be taken into consideration when each of the Design/Discernment teams does its work. Information from the Best Practice Team (see article on Page 4) will also be considered.

What will be the responsibilities of the Design Team? The Lenten season will be a time of information gathering and of listening to one another's stories. We will gather as much

information as possible about each of the FaithWorks congregations—building, staff, programming, financial assets, and focus and passion for mission. Then, after Easter, the Design Team will prayerfully imagine what it would

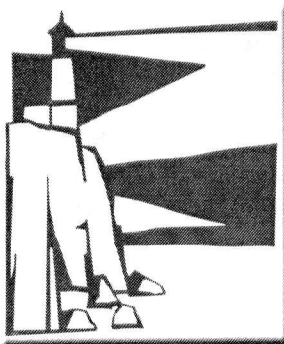

look like to “dismantle” our existing way of doing ministry among the five congregations and, with the guidance of the Spirit, cast a preliminary proposal about what a new collaborative model might look like in the future. Driven by the question, “What is God

calling us to do?”, each team will put together a plan that would affect all five congregations, including their own.

The individual plans will then be brought together in late spring to an overall FaithWorks Re-Imagining Team. That group, with representation from each of the FaithWorks congregations, will then determine where there is consensus, and where there is need for further work and conversation. It will be their task to work together to formulate an overall proposal for our future collaboration.

While time is difficult to

→ Please turn to Page 19

→ Continued from Page 18

predict, it is hoped that, where there is consensus, a number of the proposed changes will be initiated by the fall of 2013. The progress would then be highlighted with a FaithWorks celebration event to be scheduled during Advent. Each congregation will be asked for their approval and commitment to the ongoing process again in their 2014 annual meetings.

Throughout this entire process, we must be first and foremost attentive to the work of the Spirit. If you feel called to serve on our Design Team, which will have a major part in casting

the vision and re-imagining the future of the FaithWorks congregations in Racine, please contact me (262-893-1317 or mljanz@aol.com) by February 8. I look forward to our next steps with eager anticipation, confident that God is leading us and that we are stronger as we walk this path together.

Your traveling partner,

Pastor Mary

Congregation Approves Extension of Covenant

At the January 27 annual meeting of the congregation, the amended FaithWorks covenant and action plan were approved. This will commit Emmaus to the ongoing work of the FaithWorks process during 2013. There will be an update letter sent to congregational members from our FaithWorks mission council representatives, Art Smith and Melissa Lemke.

The congregation approved the proposed six-month budget.

Those elected to serve on the 2013 council are:

President, Chris Lamberton
 Vice-President, Brenda Trumbauer
 Treasurer, Art Smith
 Fund Raising, Melissa Lemke and Stacy Steinike
 Fellowship, Cheryl Dexter and Pat Jensen
 Building and Grounds, Loren Larsen
 Youth, Rich Benson
 Stewardship, Carolyn Wooster
 Member Care, Cathy Meyer
 Social Concerns, Diane Melander

In the February Visitor:

- ♥ Ash Wednesday
Services
- ♥ Building Assessment
Team Members Sought
- ♥ Community Meal
February 7
- ♥ New Hours for Thread
by Thread
- ♥ Native Gardens
- ♥ Telescopes to Tanzania
- ♥ Gentle Worship
- ♥ Mt. Pleasant Pledges
Lenten Offerings
- ♥ Re-Imagining Future
- ♥ Annual Meeting
Results

Emmaus Evangelical Lutheran Church
1925 Summit Avenue
Racine, Wisconsin 53404-2374

Change service requested

Non-Profit Org.
U.S. Postage PAID
Racine, WI
Permit No. 137

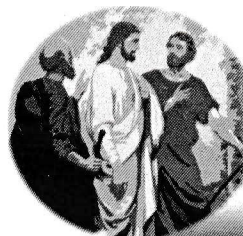

Emmaus Visitor

March, 2013

Lenten Pilgrimage Leads to Prayer Walk of the Passion

Wednesday, March 20, Emmaus/Emaús will host the last of the Wednesdays of the FaithWorks Lenten pilgrimage. The community, together with members of the other FaithWorks congregations, will be our guests. Between 5:00 and 6:00 p.m. "tour guides" will be available to welcome people and to give tours of the building, including the second floor murals created by David Holmes.

At 6:00 p.m., everyone is invited to Fellowship Hall for a full meal. During this time, there will be an opportunity to hear the story of Emmaus/Emaús through a short video being produced to tell our story.



At 7:00 p.m. there will be a procession, beginning at the back circle drive, where the crowds shout "Hosanna" and wave palms, as they greet Jesus and the live donkey making their entry into Jerusalem (circling around the field area of the church). The crowd then enters the sanctuary to a changed mood. The time which precedes Jesus' death is reenacted

by the children, with the story being told through mime and the narrator. At the end, all are invited to the haunting experience of entering the tomb—a time for prayer and reflection.

Emmaus Evangelical Lutheran Church
"Sent Forth by God's Blessing"
e-mail: emmausracine@sbcglobal.net
<http://www.emmaus-racine.org>

1925 Summit Avenue
Racine, Wisconsin 53404
Phone: 262 634-5515
Fax 262 634-0835

Pastoral Acts

Baptisms:

Alonso Alexander Garay
February 16, 2013

Alonso is the 1-year-old son of Cinthya and Jose Garay. His sponsors are Jesus and Griselda Olguin.

Funeral:

Patricia Sorensen Devine
January 31, 2013

Pat is a cousin of Sandy Strini and daughter of the late Al and Sally Sorensen. She was owner operator of a bookstore in Westgate mall. She is survived by her husband, Michael, and their children Deanna, Michelle and Kerri, three brothers and four grandchildren.

Emmaus Joins Fellow FaithWorks Congregations for Holy Week Services

The worship service on Passion Sunday, March 24, will begin with the traditional Procession of Palms. Worship services are at 5:00 p.m. Saturday, March 31, and at 9:15 a.m. Passion Sunday, April 1, will begin with the traditional Procession of Palms. Worshipers will become a part of the passion story as we participate in a dramatic reading of the Passion narrative.

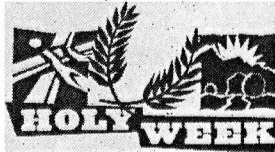

Maunder Thursday

Pastor Jhon Freddy will lead a Spanish language worship service at 7:00 at Emmaus. For an English language service, we invite you to join with other FaithWorks congregations at St. Andrew Lutheran Church, 1015 Four Mile

Road, Thursday, March, 28 at 7:00 p.m.

Good Friday

You are invited to experience the crucifixion at St. Andrew Lutheran Church, 1015 Four Mile Road at 7:00 p.m. This is a joint worship of FaithWorks congregations.

Atonement Hosts Easter Vigil March 30

We will not have the usual 5:00 p.m. worship service on March 30. Join us for a celebration of visuals, Word, song and Baptisms at Atonement Lutheran Church, 2915 Wright Avenue, at 8:00 p.m.

FaithWorks Pilgrimage Continues Wednesdays in Lent

The congregations of FaithWorks Racine continue their Lenten series of Wednesday evening worship services at each congregation in turn. Dinner is served at 6:00 with worship services beginning at 7:00 p.m.

The Ascension Mime group will present their version of the Passion story at Atonement Lutheran Church, 2915 Wright Avenue, on March 6. For nineteen years, the Ascension Lutheran Church Youth of Waukesha have shared the passion story of Christ. After six weeks of rehearsal, they share it with a different church each Wednesday and Sunday during Lent. The cast is made up of about 40 high school youth. This powerful presentation will be an opportunity for you to experience the story of Jesus' betrayal and execution in a new and meaningful way.

Our Savior's Lutheran Church, 2219 Washington Avenue, hosts the worship service on March 13. Milwaukee native Arno Michaelis III has a powerful story. He was once the head of one of the largest skinhead hate groups in the country and lead singer in the racist metal band Centurion. He hated the church and was a "reverend" in a self-proclaimed racial holy war. His life was turned



around by love and forgiveness and his story is well worth hearing and bringing your children and grandchildren to hear as well. Mr. Michaels is author of *My Life After Hate*. There will be a special presentation for kids at 5:00 p.m.

Emmaus will present The Prayer Walk of the Passion on March 20. (See story on page 1).

Need a ride? Call the church office ahead of time so that arrangements can be made.

Beware the Ides of March

The final days of March coincide with Easter weekend this year, so please get your articles for the April *Visitor* in to the church office by March 15. We would like to get the *Visitor* to your mailbox before Easter if at all possible.

Celebrate Christ's Resurrection March 31

Pastor Mary will lead a celebration of the empty tomb at 9:15 a.m. Easter Sunday, March 31. The service will be marked with festive floral decorations, music by Joyce Kaiser and the Brass Nickel, and the proclamation of the Easter message.

Pastor Jhon Freddy will lead an Easter celebration in

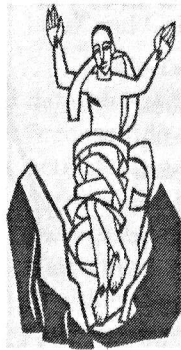

Spanish at noon, featuring the music of the Latino Praise Band.

We will celebrate the sacrament of Holy Communion at both of these festival services. We hope you will join us on this journey from the palms and hosannas of Passion Sunday to the Good News of the resurrection on Easter.

Emmaus Congregations Meet for Easter Brunch

Once again this year, thanks to Danny Johnson and his crew, a full Easter brunch will be offered in Fellowship Hall, beginning at 10:30 a.m. March 31. Join us as those

from the 9:15 festival Easter worship service and those who worship in Spanish at noon enjoy food and fellowship together!

Emmaus Staff & Worship Times

Church: 1925 Summit Avenue, Racine, Wisconsin 53404-2374.

emmausracine@sbcglobal.net ☎ 262 634-5515

Pastors:	Rev. Mary L. Janz	1530 S. Main St. 53403	mljanz@aol.com	ext. 201
	Jhon Freddy Correa		jhoncorrea@hotmail.com	ext. 202
Church office:	Paul Berge		emmausracine@sbcglobal.net	ext. 200
EASY Coord.:	Nancy Smith		nnsdaisy@aol.com	ext. 203
EASY Admin.:	Liliana Moncada		moncada_liliana@hotmail.com	ext. 204
Council President:	Chris Lamberton		clamberton@wi.rr.com	
Accompanist:	Brenda Trumbauer		brenda6175@gmail.com	
Custodians:	Rich Benson & Antelmo Hernandez		Directory:	dial 8

English language services are held at Emmaus Saturday evenings at 5:00 and Sunday mornings at 9:15. Spanish language worship services are offered Sundays at noon and March 28 at 7:00. Emmaus hosts the FaithWorks Racine Lenten midweek service Wednesday, March 20 at 7:00 p.m. There will not be a regular Saturday service on March 30.

Emmaus office hours are 9:00 a.m. to 3:00 p.m. Monday through Friday (closed at noon March 29 and all day April 1).

The VISITOR is published monthly September to July. The deadline for the April VISITOR is March 15. Please submit articles to Paul Berge's attention by mail or by e-mail.

Emmaus Visitor

Vol. 41, No. 7

March, 2013

Brass Nickel Returns for Easter Worship

The Brass Nickel will provide special music for our Festival Easter services on March 31. Donations to help defray the cost can be earmarked "Easter Music" on your offering envelope. Note the amount on the blank on the right side of your offering envelope and note "Easter music" above it, or include that notation on your



check if you do not use your offering envelope. If you make your donation on line (you may use the "Electronic Fund Giving" link at www.emmausracine.org), select "Other" as the category and note "Easter music" in the space provided.

Wednesday Night Kids Prepare for Passion Walk

Anticipation is already beginning to build for the March 20 Prayer Walk of the Passion. This presentation is a reenactment of the Passion of Christ through the eyes of kids. This moving presentation is narrated with music accompaniment.

Roles have been chosen. The kids will act out the final week of Christ's life from Palm Sunday through the Last Supper, the trial and crucifixion and conclude with quiet time in the

tomb. There will be a live donkey to lead the procession through the neighborhood and into the church. The mood of joy and celebration as Jesus enters Jerusalem quickly changes into the realization that Jesus' time on earth is suddenly about to come to an end.

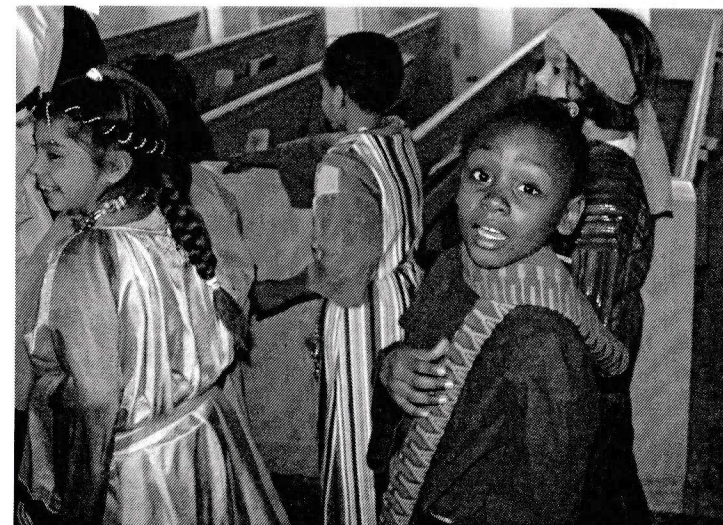

Science Keeps EASY Kids Smiling

The EASY kids have had quite a time with science in February. What happens when you put a balloon that is full of static near an empty soda can? You create the energy for a soda can race. The static balloon has enough power to move a can from one end of the room to the other.

To celebrate Valentine's Day, the kids made heart pumps. If you take a cut-off balloon and place it over a cup filled with water and insert two straws into the cup, then push on the balloon, you create

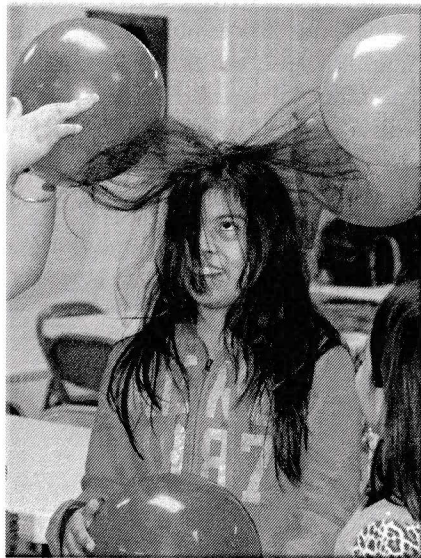

enough pressure to get the water to spurt out of the straws. They also found their pulses and listened to their hearts.

FaithWorks Youth Team Meets Here

The FaithWorks Youth Team will meet in the Sunset Room at 2:00 p.m. Saturday, March 16.

Youth Birthdays

Nolan Meteyard	Mar. 3	3
Cameron Palmgren	Mar. 4	2
Jiselle Dominguez	Mar. 5	8
Nancy Aragon	Mar. 6	3
Paul Velasquez Jr.	Mar. 6	14
Marilena Velasquez	Mar. 7	15
Natalie Garcia	Mar. 8	3
Fernando Cruz	Mar. 9	4
Veronica Medina	Mar. 11	10
Jackson Tepley	Mar. 12	9
Katie Maranger	Mar. 15	14
Jovanna Hernandez	Mar. 18	10
Jesper Christensen	Mar. 21	1
Lukas Burns	Mar. 23	8
Adrian Sanchez, Jr.	Mar. 25	3
Angie Mendoza	Mar. 31	4

Souper Bowl of Caring Tops \$6 Million

As of February 20, 6,146 groups collected nearly \$6.6 million in cash and food items for 2013 Souper Bowl of Caring.

Emmaus Visitor ☩ March, 2013 ☩ Page 6

Emmaus raised \$165.61 through a "noisy offering" on February 2 and 3 to be donated to the Northside Food Pantry.

Lenten Offerings Benefit Outreach

Outreach For Hope, the arm of our synod that provides funding for our outreach ministry at Emmaus and generous support for Neighborhood Camp, is again offering the opportunity to help to support ministry to and with people in poverty. During this Lenten season, we are encouraged

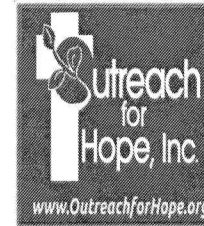

to give \$1.00 a day for 40 days. You decide what daily amount is right for you—50 cents, a dollar, or even five dollars a day.

All gifts will be forwarded to Outreach for Hope after Easter. Gifts received will be used to support 21 congregations and ministries in the Greater Milwaukee Synod. Your gift directly touches lives right here in southeast Wisconsin! Thank you for your generosity!

Pray for Better Weather When Emmaus Serves April St. Patrick's Community Meal

Emmaus will prepare and serve the food at the St. Patrick's Community Meal site on Thursday, April 4. A sign-up sheet is on the table in the narthex for those who can help by preparing a casserole, jello, or dessert, and for those who can help serve the food.

Thank you to all who braved the worst weather of the winter to provide for our meal in February!

9"x13" pans are available in the kitchen off the Sunset Room. Please tape your name to the pans (whether they are yours or were borrowed from the church) so they can be returned.



Casserole ingredients:

2 lbs. ground beef
Onion (chopped, diced or grated)
Salt and pepper
1½ lbs. french cut green beans (frozen)

2 cans of cream of chicken or cream of mushroom soup

1½ lbs. tater tots

Brown the beef, onion, salt and pepper and put them in the bottom of a 9"x13" pan.

Sprinkle the green beans over the beef. Pour both cans of soup over the beans.

Spread the tater tots over the top of the casserole.

Bake at 350°F for 45 minutes.

Emmaus Visitor ☩ March, 2013 ☩ Page 7

Flowering plants, symbolizing rebirth, have long been used to enhance the worship experience at Easter services. We offer a wide variety to choose from again this year. Choose from the plants listed below to decorate Emmaus on this special day. The plants will be yours to take after the late worship service on Easter Sunday, March 31.

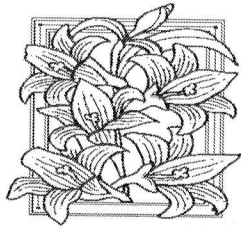

Please indicate your choice of plant(s) on this order form and return it to the church office by March 17.

<u>Quantity</u>	<u>Description</u>	<u>Cost per plant</u>
_____	6" white Easter lily (5-8 flowers)	\$9.00
_____	6" chrysanthemums	\$9.50
_____	7" cineraria	\$10.00
_____	6½" daffodil (3-4 flowers)	\$10.00
_____	6½" hyacinth (3-4 flowers)	\$10.00
_____	6½" tulip (6-7 flowers)	\$10.00
_____	7" regal geranium	\$10.00
_____	7" azalea	\$16.00
_____	7" hydrangea (3-5 flowers)	\$17.00
Total enclosed		_____

Your name(s): _____ Phone _____

Given in memory honor of: _____

I will take my plant home. Please give my plant to a shut-in
 Counters mark if paid. Office mark: Bulletin Order list

Volunteers Sought for March 20 Event

Needed: Greeters, tour guides, ushers, kitchen crew when Emmaus hosts the March 20 FaithWorks Pilgrimage. How can

you help? Training provided! See Pastor Mary, and ask how you can give an hour or two of your time.

March Worship Leaders

	Altar Guild	Communion Assts.	Readers	Ushers
Sat. Mar. 2 5:00 pm	Judy Berndt Linda Meteyard	—	—	—
Sun. Mar. 3 9:15 am	Bev Hansen Audrey Villalobos	Pat Jensen	Melissa Lemke	Team 1
Sat. Mar. 9 5:00 pm	Cathy Meyer Linda Clinton	—	—	—
Sun. Mar. 10 9:15 am	Barb Larsen Pat Jensen	Karen Sedgwick Kathy Christensen	Lee Woodward	Team 2 Christensen
Sat. Mar. 16 5:00 pm	Marge & Amy Zielke, M. Porcaro	—	—	—
Sun. Mar. 17 9:15 am	Grace Falaschi	Joy Lippmann	Kathy Christensen	Team 3
Wed. Mar. 20 7:00 pm	Kathy Christensen Marlyn Christensen	—	—	Team 4 Meteyard
Sat. Mar. 23 5:00 am	Barb & Jamie Toslek	—	—	—
Sun. Mar. 24 9:15 am	Caren Lamberton	Carol Eschmann Shirley Velzka	Nancy Smith Karen Sedgwick	Team 5 Porcaro
Sun. Mar. 31 9:15 am	Joy Lippmann	Joy Lippmann Pat & Ron Jensen	Karen Sedgwick	Team 1
Sat. Apr. 6 5:00 pm	Cheryl Dexter	—	—	—
Sun. Apr. 7 9:15 am	Barb Larsen Pat Jensen	Cindi Larsen	Sandy Strini	Team 2 Christensen

Fellowship Hosts

March 3: Pat Jensen & Cheryl Dexter

March 24: Maribel and children

Fellowship hosts are needed! Call the church office to sign up for a Sunday.

Sunday

Monday

Tuesday

Wednesday

Thursday

Friday

Saturday

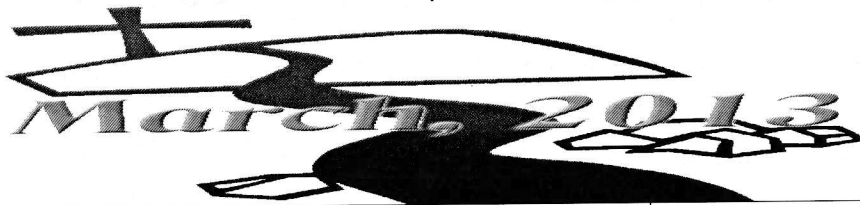

Emmaus Evangelical Lutheran Church
1925 Summit Avenue, Racine, Wisconsin 53404-2374
Phone 262-634-5515. Email emmausracine@sbcglobal.net
http://www.emmaus-racine.org
Follow "Emmaus Lutheran Racine" on Facebook.

1 Pastor Mary on vacation to March 8

2 10:00 am Clase de 1ª comunión
5:00 pm Worship service with Holy Communion

3 3RD SUNDAY IN LENT
9:15 am Worship service with Holy Communion (English)
10:30 am Coffee & fellowship
12:00 d Santa misa (español)
12:30 pm Kids' Camp (bilingual)

4 10:00 am Knit One, Purl One
3:00 pm EASY
6:00 pm Coach group in Spanish

5 3:00 pm EASY
5:00 pm TOPS
6:00 pm GED class

6 3:00 pm EASY
6:00 pm Supper at Atonement
7:00 pm Lenten worship service at Atonement

7 11:00 am Sunday bulletin deadline
No EASY
4:00 pm BENNU legal consultation
6:00 pm Ensayo de coro
6:00 pm GED class

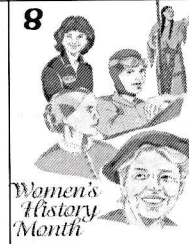

9 10:00 am Clase de 1ª comunión
5:00 pm Worship service with Holy Communion
2:00 am Daylight Savings Time begins

Pastor Mary on vacation to March 8.

10 4TH SUNDAY IN LENT
9:15 am CST Worship service with Holy Communion (English)
10:30 am Coffee & fellowship
12:00 d Santa misa (español)
12:30 pm Kids' Camp (bilingual)

11 10:00 am Knit One, Purl One
No EASY this week
6:00 pm Coach group in Spanish

12 5:00 pm TOPS
6:00 pm GED class

13 1:30 pm Lydia Circle
6:00 pm Supper at Our Savior's
7:00 pm Lenten worship service at Our Savior's

14 11:00 am Sunday bulletin deadline
6:00 pm Ensayo de coro
6:00 pm GED class

15 April Visitor articles due

16 2:00 pm FaithWorks Youth Team meeting
5:00 pm Worship service with Holy Communion

17 5TH SUNDAY IN LENT; ST. PATRICK'S DAY
Easter flower orders due
9:15 am Chicago Folk service with Holy Communion
10:30 am Coffee & fellowship
12:00 d Santa misa (español)
12:30 pm Kids' Camp (bilingual)

18 10:00 am Knit One, Purl One
3:00 pm EASY
6:00 pm Coach group in Spanish

19 St. JOSEPH
No Keenagers
3:00 pm EASY
5:00 pm TOPS
6:00 pm GED class
6:30 pm Church council

20 DAY OF PRAYER FOR PEACE IN MIDDLE EAST
3:00 pm EASY
6:00 pm Supper at Emmaus
7:00 pm Passion prayer walk worship at Emmaus

21 11:00 am Sunday bulletin deadline
3:00 pm EASY
4:00 pm BENNU legal consultation
6:00 pm Ensayo de coro
6:00 pm GED class

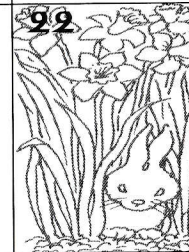

23 5:00 pm Worship service with Holy Communion

24 PASSION OF OUR LORD SUNDAY
9:15 am Worship service with Holy Communion
10:30 am Coffee & fellowship
12:00 d Santa misa (español)
12:30 pm Kids' Camp (bilingual)



25 ANNUNCIATION OF OUR LORD
10:00 am Knit One, Purl One
3:00 pm EASY
6:00 pm Coach group in Spanish

26 PASSOVER
9:00 am WCATY
3:00 pm EASY
5:00 pm TOPS
6:00 pm GED class
7:00 pm Fireside Exchange

27 9:00 am Bulletin deadline
3:00 pm EASY

28 MAUNDY THURSDAY
3:00 pm EASY
7:00 pm Misa de Jueves Santo (español)
7:00 pm Worship service at St. Andrew (English)

29 GOOD FRIDAY
Office closed in afternoon
6:00 pm Worship at St. Andrew

30 8:00 pm Easter vigil service at Atonement LC

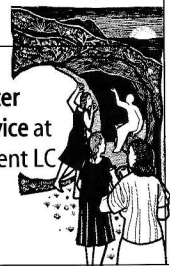

31 RESURRECTION OF OUR LORD
9:15 am Festival service with Holy Communion
10:30 am Easter brunch
12:00 m Santa misa (español)
12:30 pm Youth activity (bilingual)

April 1 Office closed

2 ELECTION DAY
3:00 pm EASY
5:00 pm TOPS

3 3:00 EASY



4 11:00 am Sunday bulletin deadline
3:00 pm EASY
5:00 pm Community Meal at St. Pat's

5

6 10:00 am Clase de 1a comunión
5:00 pm Worship service with Holy Communion

Thank You for Help and Prayers

To All My Emmaus Family Friends:

This comes a bit late, but I want to thank all my friends at Emmaus who made my recovery from surgery such a help. To all the ladies who came over and surprised me, and filled my freezer so I would not have to cook, I thank



you so much. Then a big thank you for all the prayers from every one. I could truly feel my friends were with me as well as God. Thank you from the bottom of my heart. I have never felt so blessed.

God bless,
Boots LeRoux

Keenagers Will Not Meet in March

Emmaus' social group for the young at heart will take the month of March off.

March Birthdays: 70 Years and Better

Mar. 4	Bev Hansen	130 23 rd Avenue, Kenosha	53140
Mar. 7	Pat Jensen	5512 West Branch Trail	53402
Mar. 19	Bonnie French	2301 Summit Avenue	53404

Crunching the Numbers

Weekly worship attendance averages (calculated as of Feb. 17, 2013)

	2011				2012				2013		
	Sat	Sun	Dom	Wed	Sat	Sun	Dom	Wed	Sat	Sun	Dom
Jan.	16	59	143	54	12	44	186	49	12	38	178
Feb.	14	52	136	49	14	43	183	10	14	36	180
Ash	Eng.: 10		Sp.: 226		Noon: 13		7:00: 200		Noon: 10		7:00: 190
Mar.	21	113	204	93	17	56	189	14			

Financial Figures

Total for month 2013 to date

Gen'l Fund offerings received in Jan. '13: \$ 10,000.26 } \$10,000.26

Mortgage retirement offerings received in Jan. '13: \$140.00 Campaign TD: \$71,872.62.62

Mortgage payments in Feb., 2013: Principal \$832.79

Interest..... \$159.21

Total..... \$992.00

Principal balance as of February 14, 2013: \$30,487.62

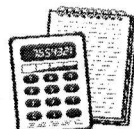

Workshops Offer Advice for Green Lawns

by John Berge

In my column last month, I discussed some of the advantages of planting native species in our yards and avoiding the monoculture of a Kentucky bluegrass lawn and only exotic species in the gardens. For those not quite ready for a leap that far, they might want to attend one of the free workshops offered by the Root/Pike Watersheds Initiative (WIN) entitled "Greener Yards, Cleaner Water." These workshops will be given at five different locations and four different dates.

Preregistration is required and can be done at the Root/Pike WIN website, rootpikewin.org, or by calling (262) 898-2055.

- Thursday, April 4, 2013, 5:30 - 7:30 p.m. Oak Creek Community Center - 8580 South Howell Avenue, Oak Creek.

- Saturday, April 13, 2013, 10:00 - noon, SC Johnson iMet, Auditorium, Room #104, 2320 Renaissance Blvd., Sturtevant.

- Saturday, April 13, 2013, 10:00 - noon, Kenosha Public Museum, 5500 1st Avenue, Kenosha.

- Saturday, April 20, 2013, 10:00 - noon, Celebrate Earth Day, Gateway Technical College-

Kenosha Campus, Technical Building, Room T130, 3520 30th Avenue, Kenosha.

- Saturday, April 27, 2013, 10:00 - noon, New Berlin City Hall Council Chambers, 3805 S. Casper Dr., New Berlin.

Two other means of being better environmental stewards of our yards and homes are with rain barrels and trees. Even a small tree can reduce storm runoff by up to 200 gallons per year.

According to the American Forests, a large tree can reduce runoff by 550 gallons per year. That can save a community millions of dollars in storm sewer infrastructure and reduce the amount of pollution washed into our lakes and streams. It would be best if the trees that you plant are natives rather than some exotic imports. Rain barrels can be purchased (and installed for an additional fee) from the local group of the Sierra Club. Contact Jeff Sytsma at Jeff12759@aol.com or call him at 262-637-6845.

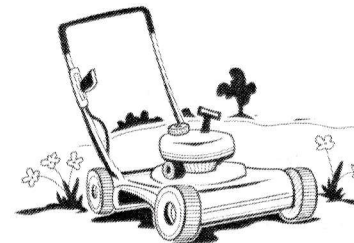

infrastructure and reduce the amount of pollution washed into our lakes and streams. It would be best if the trees that you plant are natives rather than some exotic imports. Rain barrels can be purchased (and installed for an additional fee) from the local group of the Sierra Club. Contact Jeff Sytsma at Jeff12759@aol.com or call him at 262-637-6845.

Memorials

Non-designated memorials:

In memory of Pat Devine: \$555.00

Greater Milwaukee Synod Seeks Your Nominations

The Greater Milwaukee Synod is seeking individuals, both lay and clergy, to serve on the Synod Council and Consultation Committee. The deadline to submit nominations is April 1. Elections will be held during the 2013 Synod Assembly in May.

Synod Council Vice-President (lay male or female): The synod's constitution lays out the council's role and responsibilities in great detail, but the most important considerations for those thinking of service are that the council generally meets six times a year, with special meetings possible; that it serves as the board of directors for the synod with wide latitude for decision-making



between sessions of the synod assembly; and that terms of service on the council are four years, with a second term possible. This position serves through August, 2017 (one opening).

Any member of a member church of the Greater Milwaukee Synod of the ELCA who is interested in serving should submit a nomination form to Mary Romskog at the synod office no later than Monday, April 1. Email mary.romskog@milwaukeeesyndod.org or call 414-671-1212. Nomination forms can be obtained by visiting the synod website or contacting Mary Romskog at the synod office.

Bible Readings in March

- March 3: Isaiah 55:1-9; Psalm 63:1-8; 1 Corinthians 10:1-13; Luke 13:1-9.
 March 10: Joshua 5:9-12; Psalm 32; 2 Corinthians 5:16-21; Luke 15:1-3, 11b-32.
 March 17: Isaiah 43:16-21; Psalm 126; Philippians 3:4b-14; John 12:1-8.
 March 24: Isaiah 50:4-9a; Psalm 31:9-16; Philippians 2:5-11; Luke 22:14-23:56 or Luke 23:1-49.
 March 28: Exodus 12:1-4[5-10] 11-14; Psalm 116:1-2, 12-19; 1 Corinthians 11:23-26; John 13:1-17, 31b-35.
 March 29: Isaiah 52:13-53:12; Psalm 22; Hebrews 10:16-25 or Hebrews 4:14-16; 5:7-9; John 18:1-19:42.
 March 31: Acts 10:34-43 or Isaiah 65:17-25; Psalm 118:1-2, 14-24; 1 Corinthians 15:19-26 or Acts 10:34-43; Luke 24:1-12 or John 20:1-18.

Emmaus Visitor ☩ March, 2013 ☩ Page 14

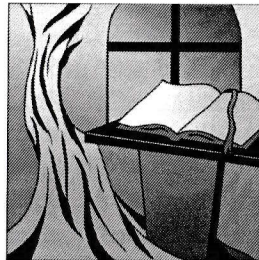

It's Never Too Early to Plan

By Stephanie Schreiner

Lincoln Lutheran advises you that it is never too early to make a plan for your future or your parents. As life spans increase and family structures change, this month think about and discuss the variety of ways to plan for long-term care, and make this planning

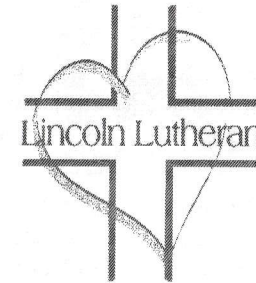

part of your personal retirement preparation. Maintain your independence and choose where you will want to be. If you would like information on planning for the future, visit www.lincolnlutheran.com to see what options are available to you.

Northside Food Pantry Schedule

Trinity United Methodist Church, 3825 Erie Street, 1:30 to 4:00 p.m.

February 28: Boots LeRoux, Pat and Ron Jensen, James Larrabee.

March 28: June Beck, James Larrabee, Cheryl Dexter, Cindi Larsen.

April 25: James Larrabee, Kathy and Rich Christensen, Karen Sedgwick.

If you are unable to work your scheduled date, please trade with someone on the schedule. Please do not leave only two people on duty. Thank you for your support of this important ministry.

Store Coupons Benefit Emmaus

Boston Store community coupon books are now available. See Sandy Strini if you are interested in purchasing one or in helping sell them to your friends

and family. The entire \$5.00 donation is kept by Emmaus. The event takes place March 1 and March 2.

March 10 Hours to Be Cut More Than 4%

There is no truth to the rumor that the loss of an entire hour at 2:00 a.m. the morning of Sunday, March 10 is a result of federal



budget sequestration. Daylight Savings Time is back! Be sure to set your clocks ahead one hour on Saturday night, March 9.

Emmaus Visitor ** March, 2013 ** Page 15

Develop the Capacity to Forgive

"Father, forgive them for they know not what they do."

He turned it over to God. He let it go, all of it—the taunting, the bullying and mocking, the unfair arrest, the being convicted to a death sentence in spite of his innocence. There he

was on a cross about to die, and Jesus makes this plea. He had taught, "Love your enemies," but this is *so* extreme. He was living...and dying ...by those very words he had taught during his ministry.



"Forgive us our trespasses as we forgive those who trespass against us." Those are words we pray so frequently in the prayer that Jesus taught us to pray. How often, as we pray this prayer, are we holding a grudge, anger, resentment or bitterness aimed at someone who has wronged us? How often do we feel shame because we cannot forgive ourselves for the ways we have caused brokenness or hurt or disappointment to others or to God?

In his book *Why Forgive?*, Johann Arnold quotes Martin Luther King Jr. from a passage of his book, *Strength to Love*, (pp 28 and 29):

"Returning hate for hate multiplies hate, adding deeper darkness to a night already devoid of stars. Darkness cannot drive out darkness; only light can do that. Hate cannot drive out hate, violence multiplies violence, and toughness multiplies toughness in a descending spiral of destruction..."

"Love is the only force capable of transforming an enemy into a friend. We never get rid of an enemy by meeting

hate with hate; we get rid of the enemy by getting rid of enmity. By its very nature, hate destroys and tears down; by its very nature, love creates and builds up. Love transforms with redemptive power.

"We must develop and maintain the capacity to forgive. Whoever is devoid of the power to forgive is devoid of the power to love..."

During this Lenten season we continue to reflect on repentance, transformed lives and what it means to forgive and be forgiven. Former skinhead and white supremacist, Arno Michaelis, who is scheduled to speak at our March 13 FaithWorks

→ Please turn to page 19

→ Continued from page 18

Lenten service at Our Savior's, is the first to admit that forgiving himself is the most difficult part of his personal process of transformation. Sammy Rangel, former gang member, who spoke on February 20, has initiated the Forgiveness Project as a part of his transformation as he reaches out to help others.

We, as Christians, are all called to reach out with love and compassion, sharing this transformative word of forgiveness and unconditional love with a hurting, broken, and angry world. Yes, this even includes our enemies. It's an ongoing process

that is possible only because we ourselves walk loved and forgiven by the One we worship, the One into whose death and resurrection we have been baptized. Let's claim that identity!

Looking forward to the empty tomb!

Pastor Mary
Save the date! - Fiesta Mexicana - May 18

CAPTIVE FREE
WEST LAKES

Young adults seeking to experience God with you and taking faith to the next level through worship and service together.

Thursday, February 28
Spark 4:30 p.m.
Worship 6:30 p.m.

Our Savior's Lutheran Church
2219 Washington Avenue
Racine, WI

www.youthcenter.org/captivefreewestlakes

Youth

Youth Encounter - St. Paul, Minnesota
800.63.VOYU74 - www.youthencounter.org
facebook.com/youthencounter
twitter.com/youthencounter

In the March Visitor:

- ⊕ FaithWorks Lenten Pilgrimage
- ⊕ Holy Week Services
- ⊕ Easter Worship, Brunch
- ⊕ Static in the Air
- ⊕ Recipe for Community Meal
- ⊕ Easter Flower Order Form
- ⊕ Synod Solicits Nominees
- ⊕ Developing Capacity to Forgive

Emmaus Evangelical Lutheran Church
1925 Summit Avenue
Racine, Wisconsin 53404-2374

Change service requested

Non-Profit Org.
U.S. Postage PAID
Racine, WI
Permit No. 137

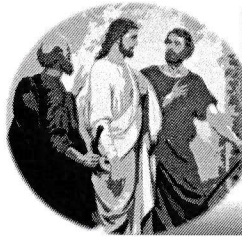

Emmaus Visitor

April, 2013



Some of our kids came out in the cold to meet Mamacita, the donkey here for the Prayer Walk of the Passion on March 20. Story on page 6.

Emmaus Evangelical Lutheran Church
"Sent Forth by God's Blessing"
e-mail: emmausracine@sbcglobal.net
<http://www.emmaus-racine.org>

1925 Summit Avenue
Racine, Wisconsin 53404
Phone: 262 634-5515
Fax 262 634-0835

Funeral:

Martin C. Andersen
March 1, 2013

Marty passed away peacefully at Elizabeth Residence on February 25. He retired from Twin Disc in 1990, and had been active in the Bell City Investment Club, Danish Brotherhood and Dania Hall. He is survived by Marion, his bride of 64 years; their daughters Nancy LaForest, Mary Kophamer and Janet Macemon; eleven grandchildren and eleven great-grandchildren. Pastor Michael Mueller from St. Andrew led the funeral service.

Remember Our Friends in Your Prayers

Please keep the family of Barb Fogarty's father, Bill Kluge, in your prayers. Mr. Kluge died on March 24. In accordance with Mrs. Kluge's wishes, there will not be a

funeral service. Barb Fogarty worked with Neighborhood Camp and the EASY program several years ago.

Emmaus Shows Oscar-Winning Films

By Laura Bernett & Brenda Trumbauer

It's movie time again! Let's step into spring and have some fun!

At 6:00 p.m. Saturday, April 6, we're showing "Silver Lining Playbook."

At 2:00 p.m. Sunday, April 7, the feature film is Stephen Spielberg's "Lincoln."

Bring a snack to share. At Mitchell Wagon Factory Lofts

"Little Theater," 815 Eighth Street, Racine.

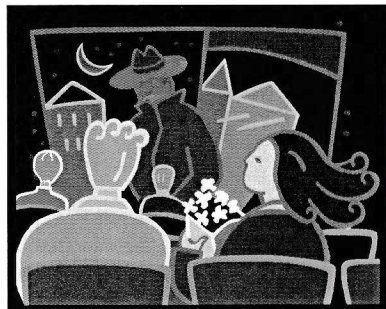

The first 15 to 20 people to sign up for either day will have a reserved seat, since seating is limited. Or call Laura at

262-422-9544. Sign-up will be at coffee hour after Sunday service in the Sunset Room.

Atonement Hosts FaithWorks Easter Vigil

We will not have the usual 5:00 p.m. worship service on March 30. Please join the whole FaithWorks community at 8:00 p.m. at Atonement Lutheran Church, 2915 Wright Avenue, for a

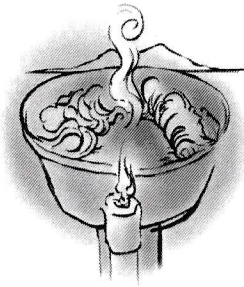

celebration in which all the signs of faith and hope come together as we pass over with Christ from darkness to light, from bondage to freedom, and from death to life.

Easter Sunday Services

Christ Is Risen! Alleluia!

Pastor Mary will lead a celebration of the empty tomb at 9:15 a.m. Easter Sunday, March 31.

The service will be marked with festive floral decorations, music by Joyce Kaiser and the Brass Nickel, and the proclamation of the Easter message.

The Brass Nickel will provide special music for our Festival Easter services on March 31. Donations to help defray the cost can be earmarked "Easter Music"

on your offering envelope. Note the amount on the blank on the

right side of your offering envelope and note "Easter music" above it, or include that notation on your check if you do not use your offering envelope.

Pastor Jhon Freddy will lead an Easter celebration in Spanish at noon, featuring the music of the Latino Praise Band.

We will celebrate the sacrament of Holy Communion at both of these festival services. We hope you will join us on this journey from the palms and hosannas of Passion

Sunday to the Good News of the resurrection on Easter.



Emmaus Congregations Meet for Easter Brunch

Thanks to Danny Johnson and his crew, Emmaus offers a full Easter brunch in Fellowship Hall in memory of Betty Johnson. The meal begins at 10:30



a.m. March 31. Join us as those from the 9:15 festival Easter worship service and those who worship in Spanish at noon enjoy food and fellowship together!

Emmaus Celebrates Fiesta Mexicana May 18

The annual Fiesta Mexicana fund raiser returns this May. Meal tickets and raffle tickets will soon be available for sale. Donations of items for a silent auction are encouraged. Please check the website, future bulletins and the May *Visitor* for more details. Meanwhile, tell your friends about this special event, and be sure to

mark your calendar for Saturday, May 18.

Are you able to volunteer your time either before or during the Fiesta? Contact the church office, Melissa Lemke, Liliana Moncada or Stacy Steinike regarding the ways you may be able to pitch in for this fun event.

Emmaus Staff & Worship Times

Church: 1925 Summit Avenue, Racine, Wisconsin 53404-2374.

emmausracine@sbcglobal.net ☎ 262 634-5515

Pastors:	Rev. Mary L. Janz 1530 S. Main St. 53403 mljanz@aol.com ext. 201	Jhon Freddy Correa jhoncorrea@hotmail.com ext. 202
Church office:	Paul Berge emmausracine@sbcglobal.net ext. 200	
EASY Coord.:	Nancy Smith nnsdaisy@aol.com ext. 203	
EASY Admin.:	Liliana Moncada moncada_liliana@hotmail.com ext. 204	
Council President:	Chris Lamberton clamberton@wi.rr.com	
Accompanist:	Brenda Trumbauer brenda6175@gmail.com	
Custodians:	Rich Benson & Antelmo Hernandez	Directory: dial 8

English language services are held at Emmaus Saturday evenings at 5:00 and Sunday mornings at 9:15. Spanish language worship services are offered Sundays at noon and March 28 at 7:00. There will not be a regular Saturday service on March 30.

Emmaus office hours are 9:00 a.m. to 3:00 p.m. Monday through Friday (closed at noon March 29 and all day April 1).

The VISITOR is published monthly September to July. The deadline for the May VISITOR is April 15. Submit articles to Paul Berge's attention by mail or by e-mail.

Emmaus Visitor

Vol. 41, No. 8

April, 2013

Page 4

EASY Eases into Spring

It's hard to believe that EASY has just seven weeks remaining this year. After a

tumultuous change in schedule

during the snowy months of February and March, and the preparation

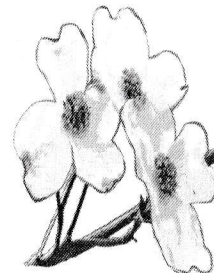

for the Prayer Walk, we are hopeful that the schedule is back to normal. (The groundhog is in trouble!)

Mentors, thank you for your patience during this time.

The closing dinner and program for EASY will be on Wednesday, May 15.

Youth Birthdays

Sarah Albright	April 4	13
Carlos Garcia	April 4	15
Rafael Carrasquillo	April 9	3
Kamaria Cardenas	April 10	3
Anna Posadas	April 13	6
Michaela Keller	April 18	15
Jose Medina	April 19	11
Brisa Antonio	April 20	4
Evelyn Valentin	April 20	7
Miguel Aragon Vasquez		
	April 27	7
Marco Posadas	April 27	9

Fund Raising Efforts Continue

The Charcoal Grill "Dine and Donate" fund raiser on February 12 raised \$147.

We continue to sell Scrip gift cards after weekend worship services. In addition to a variety of gift cards that we have on hand,

we also have a complete list of businesses that offer Scrip gift cards, and we can order those cards for you.

If you have any questions about the Scrip program, please contact Cathy Meyer.

Northside Food Pantry Volunteers

Trinity United Methodist Church, 3825 Erie Street, 1:30 to 4:00 p.m.

April 25: James Larrabee, Kathy and Rich Christensen, Karen Sedgwick.

May 23: Pat & Ron Jensen, James Larrabee, Boots LeRoux

If you are unable to work your scheduled date, please trade with someone on the schedule. Please do not leave only two people on duty. Thank you for your support of this important ministry.

Emmaus Visitor ☩ April, 2013 ☩ Page 5

Prayer Walk Touches Lives

The Prayer Walk of the Passion was the final Wednesday Night of the FaithWorks Lenten series. Kids dressed in costume presented the Passion of Christ in mime as a narration of the last week of Christ was read. This “hands on” presentation by the kids gives them a deeper understanding of the different emotions of the last week in Christ’s life.

Jesus, played by Chris Lambertson, led the disciples and followers into the sanctuary leading a live donkey. The passion then moved to the Last Supper where Jesus washed the disciples’ feet to show them how to be servants and commanded them to Love One Another.

Jesus moved to the Garden of Gethsemane, where Judas betrayed Jesus with a kiss. The soldiers arrested Jesus and took him to the chief priests whereupon Peter denied knowing him. As the cock crowed Jesus was led before Pilate who washed his hands of the decision of the crowd who shouted, “Crucify him! Nail him to a cross!”

As Jesus was whipped again and again, he stumbled through the crowd carrying his own cross

until Simon was ordered to carry it for him. The narration went on to tell of Christ’s final hours and the placement of the body into the tomb.

The congregation then moved downstairs, walked



through a candlelit hallway to visit the tomb. They were invited to take a carved fish that also spelled “JESUS.” The kids who participated received a cross with the fish. Thank you to Dennis Eschmann who created these special mementoes.

Many people expressed their amazement and appreciation for this remembrance.

Thank you to all who helped with this presentation: greeters, ushers, costume helpers, middle school kids who created sound effects, and sound man Ryan Lambertson. Many thanks go to Laura Bernett and Cheryl Dexter and their crew who planned, cooked and served a fantastic meal to a full house.

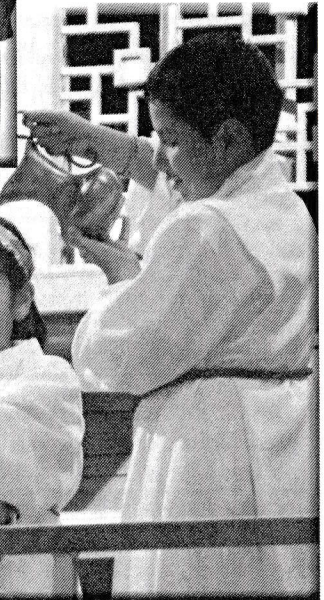

**Prayer Walk
of the Passion**
Emmaus Lutheran Church
March 20, 2013

Synod Assembly Asks the Musical Question

This year's Greater Milwaukee Synod Assembly will convene at Country Springs Hotel and Conference



Center in Waukesha, May 30 to June 1. The assembly schedule is forthcoming, but the theme has been announced: "Why?"

First Quarter Statements Available Soon

First quarter offering statements will be available early in April. Anyone who has made a contribution of record should have an offering statement in the marked box in the narthex.

Please check your offering statement to help make sure that we are correctly recording your offerings and any pledges you've made. Call Paul in the church office, 634-5515, if you have

any questions. The earlier we correct any mistakes the better.

Memorials, Honoraria

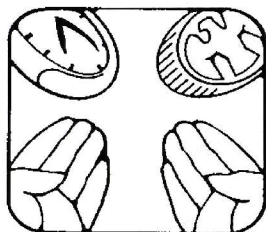

Designated for plants, groundskeeping:

In memory of Martin Andersen: \$330.00

Non-designated:

In memory of Stanley Breiwick: \$50.00

In honor of Rich & Kathy Christensen: \$50.00.

Crunching the Numbers

Weekly worship attendance averages (calculated as of Mar. 24, 2013)

	2011				2012				2013			
	Sat	Sun	Dom	Wed	Sat	Sun	Dom	Wed	Sat	Sun	Dom	Wed
Feb	14	52	136	49	14	43	183	10	14	38	180	n/a
Mar	14	61	167	45	17	56	189	14	13	55	154	288
Apr	21	113	204	93	15	70	205	143				

Financial Figures

	Total for month	2013 to date
General Fund offerings received in Feb. 2013	\$9,604.68 }	
Initial, Lent, Holiday, Adopt-Bill:	\$304.72 }	\$ 19,909.66

Mortgage retirement offerings received in Feb. '13	\$360.00	Campaign TD: \$70,539.62
Mortgage payments in Mar. 2013:		
Principal	\$841.28	Principal balance as of
Interest	\$150.72	March 14, 2013:
Total	\$992.00	\$29,650.60

April Worship Leaders





	Altar Guild	Communion Assts.	Readers	Ushers
Sun. Mar. 31 9:15 am	Joy Lippmann	Joy Lippmann, Pat & Ron Jensen	Karen Sedgwick	Team 1
Sat. Apr. 6 5:00 pm	Cheryl Dexter Shirley Irvine	—	—	—
Sun. Apr. 7 9:15 am	Barb Larsen Pat Jensen	Cindi Larsen	Sandy Strini	Team 2 Christensen
Sat. Apr. 13 5:00 pm	Brian & Denise Keller	—	—	—
Sun. Apr. 14 9:15 am	Caren Lambertson	Kathy Christensen Nancy Smith	Carol Eschmann	Team 3
Sat. Apr. 20 5:00 pm	Judy Berndt Linda Meteyard	—	—	—
Sun. Apr. 21 9:15 am	Bev Hansen Audrey Villalobos	Chris Lambertson	Chris Lambertson	Team 4 Meteyard
Sat. Apr. 27 5:00 am	Cathy Meyer Linda Clinton	—	—	—
Sun. Apr. 28 9:15 am	Kathy Christensen Marlyn Christensen	Karen Sedgwick Diane Melander	John Knuteson	Team 5 Porcaro
Sat. May 4 5:00 pm	Marge & Amy Zielke, M. Porcaro	—	—	—
Sun. May 5 9:15 am	Grace Falaschi	Carol Eschmann	Kathy Christensen	Team 1

Fellowship Hosts

April 7: Chris and Caren Lambertson
April 14: Carol and Dennis Eschmann

Easter Season Bible Readings

March 31	Acts 10:34-43 or Isaiah 65:17-25; Psalm 118:1-2, 14-24; 1 Corinthians 15:19-26 or Acts 10:34-43; Luke 24:1-12 or John 20:1-18.
April 7	Acts 5:27-32; Psalm 118:14-29 or Psalm 150; Revelation 1:4-8; John 20:19-31.
April 14	Acts 9:1-6 [or -20]; Psalm 30; Revelation 5:11-14; John 21:1-19.
April 21	Acts 9:36-43; Psalm 23; Revelation 7:9-17; John 10:22-30.
April 28	Acts 11:1-18; Psalm 148; Revelation 21:1-6; John 13:31-35.
May 5	Acts 16:9-15; Psalm 67; Revelation 21:10, 22-22:5; John 14:23-29 or John 5:1-9.

Sunday	Monday	Tuesday	Wednesday	Thursday	Friday	Saturday
<p>March 31 RESURRECTION OF OUR LORD 9:15 am Festival service of Holy Communion (English) 10:30 am Easter brunch 12:00 m Santa misa (español) 12:30 pm Kids' Camp (bilingüe)</p> <p>Emmaus Evangelical Lutheran Church 1925 Summit Avenue, Racine WI 53404 emmausracine@sbcglobal.net 262 634 5515</p>	<p>April 1 Office closed. No K1P1 or EASY 6:00 pm Coach group in Spanish 6:00 pm Neighborhood Camp meeting</p>	<p>2 ELECTION DAY 3:00 pm EASY 5:00 pm TOPS 6:00 pm GED class</p> 	<p>3 3:00 pm EASY 5:30 pm Supper 6:15 pm Study groups</p>	<p>4 11:00 am Sunday bulletin deadline 3:00 pm EASY 5:00 pm Community Meal at St. Patrick's 6:00 pm GED class 6:00 pm Ensayo de coro 7:00 pm FaithWorks at LC Redeemer</p>	<p>5 5:00 pm FaithWorks 30-Hour Famine at St. Andrew LC</p>	<p>6 10:00 am Clase de 1ª comunión 6:00 pm Movie Night at Mitchell Wagon Factory Lofts 5:00 pm Worship service with Holy Communion (English)</p>
Pastor Mary's week off						
<p>7 2ND SUNDAY OF EASTER; YOM HASHOAH 9:15 am Worship service with Holy Baptism, Holy Communion 10:30 am Coffee & fellowship 12:00 m Santa misa (español) 12:30 pm Kids' Camp (bilingual) 2:00 pm Movie night at Mitchell Wagon Factory Lofts</p>	<p>8 10:00 am Knit one, purl one 11:30 am Worship & Music committee meeting 3:00 pm EASY 6:00 pm Coach group in Spanish</p>	<p>9 3:00 pm EASY 5:00 pm TOPS 6:00 pm GED class</p>	<p>10 1:30 pm Women's Bible study 3:00 pm EASY 5:30 pm Supper 6:15 pm Study groups</p>	<p>11 11:00 am Sunday bulletin deadline 3:00 pm EASY 6:00 pm GED class 6:00 pm Ensayo de coro</p>	<p>12</p> 	<p>13 10:00 am Clase de 1ª comunión 5:00 pm Worship service with Holy Communion (English)</p>
<p>14 3RD SUNDAY OF EASTER 9:15 am Worship service with Holy baptism, Holy Communion 10:30 am Coffee & fellowship 12:00 m Santa misa (español) 12:30 pm Kids' Camp (bilingual)</p>	<p>15 May Visitor articles needed in church office 10:00 am Knit one, purl one 3:00 pm EASY 6:00 pm Coach group in Spanish</p>	<p>16 3:00 pm EASY 5:00 pm TOPS 6:00 pm GED class 6:30 pm Church council meeting</p>	<p>17 3:00 pm EASY 5:30 pm Supper 6:15 pm Study groups</p>	<p>18 11:00 am Sunday bulletin deadline 3:00 pm EASY 6:00 pm GED class 6:00 pm Ensayo de coro</p>	<p>19</p>	<p>20 DAY OF PRAYER FOR PEACE IN MIDDLE EAST 5:00 pm Worship service with Holy Communion (English)</p>
<p>21 4TH SUNDAY OF EASTER 9:15 am Chicago Folk service with Holy Communion 10:30 am Coffee & fellowship 12:00 m Santa misa & quinceañera (español) 12:30 pm Kids' Camp (bilingual)</p>	<p>22 EARTH DAY 10:00 am Knit one, purl one 3:00 pm EASY 6:00 pm Coach group in Spanish</p>	<p>23 3:00 pm EASY 5:00 pm TOPS 6:00 pm GED class 7:00 pm Fireside Exchange</p>	<p>24 3:00 pm EASY 5:30 pm Supper 6:15 pm Study groups</p>	<p>25 ST. MARK 11:00 am Sunday bulletin deadline 3:00 pm EASY 6:00 pm GED class 6:00 pm Ensayo de coro</p>	<p>26 ARBOR DAY</p> 	<p>27 5:00 pm Worship service with Holy Communion (English) 7:00 pm Misa de sanación (español)</p>
<p>28 5TH SUNDAY OF EASTER 9:15 am Worship service with Holy Communion 10:30 am Coffee & fellowship No noon worship service 12:30 pm Kids' Camp (bilingual)</p>	<p>29 10:00 am Knit one, purl one 3:00 pm EASY 6:00 pm Coach group in Spanish</p>	<p>30 12:00 pm Sunday bulletin deadline 3:00 pm EASY 5:00 pm TOPS 6:00 pm GED class</p>	<p>May 1 ST. PHILIP & ST. JAMES 3:00 pm EASY 5:30 pm Supper 6:15 pm Study groups</p>	<p>2 Secretary on vacation 3:00 pm EASY 6:00 pm GED class 6:00 pm Ensayo de coro</p>	<p>3</p> 	<p>4 STAR WARS DAY 10:00 am Clase de 1ª comunión 5:00 pm Worship service with Holy Communion (English)</p>

Emmaus Serves April 4 Community Meal

Emmaus' turn to serve the Community Meal at St. Patrick's Catholic Church falls on April 4.

For over a quarter century, this program has been a blessing to those who, for whatever reason, find themselves in need of a good hot meal. It could not have been such a success without the dedication of the church members who prepare and serve the food. We thank all who have shared in this program.

Casserole recipe:

- 2 lbs. ground beef
- Onion (chopped, diced or grated)
- Salt and pepper
- 1½ lbs. french cut green beans (frozen)



2 cans of cream of chicken or cream of mushroom soup
1½ lbs. tater tots

Brown the beef, onion, salt and pepper and put them in the bottom of a 9"x13" pan.

Sprinkle the green beans over the beef. Pour both cans of soup over the beans.

Spread the tater tots over the top of the casserole.

Bake at 350°F for 45 minutes.

April Birthdays: 70 Years and Better

- | | | | |
|---------|----------------|---|-------|
| Apr. 14 | Mavis Agerholm | 15827 N. 138 th Ave. Surprise AZ | 85374 |
| Apr. 26 | Arvilla Nemer | 816 Porter Ave., Eau Claire WI | 54701 |
| Apr. 26 | Donna Rode | 1402 Douglas Avenue #204, Racine WI | 53402 |

Neighborhood Camp Plans Get Underway

A meeting on April 1 will set the gears in motion for Neighborhood Camp. The site coordinators will begin the task of discussing calendars and themes for another fun-filled summer for the campers. Last year's staff has been inquiring about camp and

expressing excitement for summer to come soon.

Emmaus will hold camp during the month of July. Your support for this much needed enrichment program is vital. You have been there and oh how much your help is appreciated. Stay tuned!

Cards, Letters & E-mail

Thanks from Christensens

Many thanks to our Emmaus Family for honoring us on our 50th anniversary. Pastor Marcy's words of blessing, the lovely green plant and the coffee and treats in

our honor all made the occasion very special for us. But the love and caring of our Emmaus Family is the best gift of all.

— Rich and Kathy Christensen

AUTHORIZATION FORM

The Simply Giving Program
endorsed by
Thrivent Financial Bank

FOR OFFICE USE ONLY	ENVELOPE/DONOR #	DATE						
Emmaus Evangelical Lutheran Church		504744303						
Effective date of authorization: ____/____/____								
Type of Authorization Form: <table border="0"> <tr> <td><input type="checkbox"/> New Authorization</td> <td><input type="checkbox"/> Change banking information</td> </tr> <tr> <td><input type="checkbox"/> Change donation amount</td> <td><input type="checkbox"/> Discontinue electronic donation</td> </tr> <tr> <td><input type="checkbox"/> Change donation date</td> <td></td> </tr> </table>			<input type="checkbox"/> New Authorization	<input type="checkbox"/> Change banking information	<input type="checkbox"/> Change donation amount	<input type="checkbox"/> Discontinue electronic donation	<input type="checkbox"/> Change donation date	
<input type="checkbox"/> New Authorization	<input type="checkbox"/> Change banking information							
<input type="checkbox"/> Change donation amount	<input type="checkbox"/> Discontinue electronic donation							
<input type="checkbox"/> Change donation date								
Last Name		First Name						
Address								
City		State Zip						
Email Address								
FIRST DONATION DATE: ____/____/____	FREQUENCY OF DONATION: <input type="checkbox"/> Weekly on _____ <input type="checkbox"/> Monthly on _____ <input type="checkbox"/> Semi-Monthly (transferred on 1 st and 15 th of each month)	FUNDS AND AMOUNTS: <input type="checkbox"/> General Operating \$ _____ <input type="checkbox"/> Debt Retirement \$ _____ <input type="checkbox"/> Memorials \$ _____ <input type="checkbox"/> Outreach \$ _____ <input type="checkbox"/> Neighborhood Camp \$ _____ <input type="checkbox"/> Other \$ _____						
CHECKING / SAVINGS	Please debit my donation from my (check one): <input type="checkbox"/> Savings Account (contact your financial institution for Routing #) <input type="checkbox"/> Checking Account (attach a voided check below)		Routing Number: _____ Valid Routing # must start with 0, 1, 2, or 3					
			Account Number: _____ <small>Routing Number Account Number Check Number</small>					
I authorize the above church to process debit entries to my account. I understand that this authority will remain in effect until I provide reasonable notification to terminate the authorization.								
Authorized Signature: _____		Date: _____						
CREDIT CARD	Please charge my payments to my (check one): <input type="checkbox"/> Visa <input type="checkbox"/> MasterCard <input type="checkbox"/> American Express <input type="checkbox"/> Discover Card							
	Credit Card Number: _____	Expiration Date: _____						
	Name on Card: _____							
	Billing Address (if different from above): _____							
I authorize the above church to charge my credit card in accordance with the information above.								
Signature (as it appears on the credit card): _____		Date: _____						

Racine Hosts Medication Collection

by John Berge

It is good stewardship of our environment to do all that we can to keep hazardous and biologically active materials out of that environment. Unwanted and unused medications are slowly building up in our ground and surface water, partly because of improper disposal.

If you have no longer any need for the medication, don't throw it in the trash or flush it down the sink or toilet. Our wastewater treatment processes do not remove or deactivate most of these chemicals and they are then passed on to lakes or rivers which in turn are the sources of our and nature's drinking water. Studies have shown that fish in waters, such as the Chesapeake Bay, heavily polluted by drugs and other bioactive chemicals are more and more becoming "intersexed" – that is, males are growing eggs or female ovarian tissue.

So how should one dispose of unwanted medications? On April 20, the City of Racine hosts a Medicine Collection Day at the Household Hazardous Waste site, 6200 21st Street (north of the former Sam's Club building) from 8:00 a.m. to 1:00 p.m. Bring prescription and over-the-counter medications, including pet medications, ointments, creams,

sprays and inhalers. Do not bring illegal drugs, needles/sharps or personal care products such as shampoos, soaps, lotions or sunscreens.

Keep all the medications in their original containers. Cross out your name if you wish, but leave the name of the medication and seal them up in a plastic bag.

The next collection day will be the third Saturday in October. Last October, 1,426 pounds of uncontrolled substances and 173 pounds of controlled substances (narcotics) were collected, properly destroyed by incineration and kept out of the environment; 1,981 pounds of plastic containers were recycled.

While you are in that area, why not bring in your household hazardous waste? Burnt-out compact and regular (long) fluorescent light bulbs contain small amounts of mercury which would be released to the environment (even your immediate neighborhood) if put out with the regular trash collection. Bring them to the HHW collection along with unwanted automotive chemicals, oil paints and varnishes, pesticides, etc. This too is good environmental stewardship.

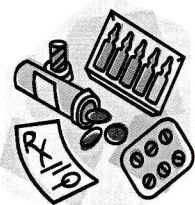

LSS Helps Adults Activate Brain Fitness

LSS MindWorks is a memory enhancement program based on current research and successful programs for people experiencing early memory loss. This program offers physical and mental exercise and helps participants develop memory strategies that allow them to cope with their changing cognitive status. LSS currently operates the MindWorks program in several locations throughout Wisconsin, including Waukesha, Jackson, Appleton, and Oshkosh.



MindWorks is a supportive place for members to proactively work on their brain fitness and provides an avenue to connect with others who understand memory loss challenges. This class brings members together twice each week, four hours each day.

The LSS MindWorks program provides a supportive environment for individuals, as well as families, experiencing early memory loss. Caregivers of program participants express that their life is less stressful and the quality of life for the family has benefited. Caregivers also consistently report that the participant has:

- Maintained or improved their ability to perform daily living activities;
- Is more social or interactive at

home;

- Has an improved quality of life.

The MindWorks team has worked hard to tailor the program to meet the needs of participants and their families. Early memory loss programming is so important as the baby boomer generation ages and families look for resources to ensure quality of life. No matter what age, brain exercise is a proven and effective tool.

Patty's Experience

"I can't say enough positive things about the MindWorks program. My mother has been attending the classes since 2008. She so looks forward to each class and truthfully hates to have them end. I know she would love to have a longer class session. As for me, it helps me tremendously! It allows me some time away from caregiving and an opportunity to do things for myself and my family." -Patty

Patty's experience is just one of the many testimonials we at LSS see every day. Thanks to your ministry through LSS, you are helping to change the world – one grace-filled life at a time.

For more information about MindWorks and other adult centered programs at LSS, please visit www.lsswis.org.

Resurrection Hosts Green Workshop

A workshop sponsored by the Racine Green Congregations, award-winning ELCA Campus Pastor & author Ron Rude will be the presenter. April 27 from 8:15 to 12:15 at the Lutheran Church of the Resurrection, 322 Ohio Street, Racine. Cost is \$15. Contact Diane Tetrault (diane.tetrault@yahoo.com). To interact with Ron about

his work or books, go to abel-emerging.com.

The Kenosha Green Team invites everyone to attend the film "Green Fire," the story of Aldo Leopold. The film will be shown at Bradford Unitarian Universalist Church, 5810 8th Avenue, Kenosha, at 7:00 p.m. on Saturday, April 13. Meet in the sanctuary.

Synod Marks Civil Rights Milestone

By Bishop Jeff Barrow

2013 marks a number of special 50th anniversaries, including the assassination of John F Kennedy and Dr. Martin Luther King Jr.'s "I have a dream" speech. One that certainly should not be missed is MLK's "Letter from a Birmingham Jail", which is one of his most power writings, one which provided a call and a challenge to the church of his time.



April 16. I have asked Ken Wheeler to preach. I have asked Elijah Furquan to write one of his fabulous poems. I am committed to listen. If that's all that happens on that night it will be worth the three of us gathering.

However, many have expressed interest in being a part of a larger celebration. We are gathering in about a week to put some flesh on the rest of the evening. I hope many of you will choose to be involved.

This is hardly a celebration simply of looking back. It is a chance to share the torch of justice as it is remembered and handed over to a new generation. Please save this date and plan to be there on Tuesday, April 16. Worship begins at 6:30 p.m. Pre-celebration music begins at 5:45 p.m.

So here's the deal. I have reserved Our Savior's Lutheran, 3022 W. Wisconsin Ave., Milwaukee, for the evening of

North Cape Women Host Craft Event

The women of the North Cape Lutheran Church will hold their annual Country Crafts 'n' Cookin' event on Saturday, April 13. The craft and bake sale runs from 10:00 a.m. until 1:30 p.m. This year's featured display is "Honoring God in Our Homes."

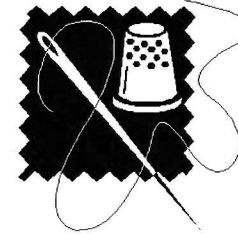

An all-you-can-eat salad buffet luncheon will be held between 11:00 a.m. and 1:00 p.m.

featuring chicken salad and shrimp salad, plus fruit and vegetable salads and an array of other main dishes. Tickets for the luncheon are \$8.50 per person (\$4.00 for ages 4-12) and are available at 262 835-2271. North Cape Lutheran Church is located on the east side of Highway 45 just south of Five Mile Road.

Volunteers Sought for MS Walk April 28

Volunteers are needed for the National Multiple Sclerosis Society-Wisconsin Chapter's Walk MS 2013 at Mary Lou Mahone Middle School, 6900 60th St., Kenosha, on Sunday, April 28. Volunteer positions include registration, set-up, clean-up, breakfast, cheering, lunch, and route support. For more information about this and other volunteer opportunities at the



National MS Society-Wisconsin Chapter, contact Ashley Wissinger (262-369-4426 or e-mail ashley.wissinger@nmss.org) or Lisa Turnacliff (262-369-4402 or e-mail lisa.turnacliff@nmss.org).

Parking is available in the lot northeast of the student union. Check-in is at 9:00 a.m. The walk starts and ends at the student union. See <http://walkwig.nationalmssociety.org> to register or volunteer.

New Vision to Visit Our Savior's

Lutheran Youth Encounter group "New Vision" will be at Our Savior's Lutheran Church, 2219

Washington Avenue, for their 9:45 a.m. worship service on Sunday, May 19.

Yesterday, Today and Tomorrow

It's so tempting, isn't it, to look back and reminisce? In fact, as I plan to be a part of two reunions in the coming year (my 50th class reunion and another reunion of people I worked with in the travel business about 40 years ago), I'm sure that we will look back and tell many stories as we surface memories of the good ol' days.

This week I have been thinking about past Easters and how they were spent. There are the memories of dyeing the hard boiled eggs my mom had prepared and then finding those same eggs mysteriously hidden throughout the house on Easter morning. There were those many Easters that as a young girl I looked forward to shopping for the new dress, hat and white gloves to be donned Easter morning—sun or snow. And then there was the year we couldn't go to the early service because there was none. There had been a major blizzard, and all the Holy Week and Easter services were cancelled!

I also recall those years that I was out of the church, disillusioned because it didn't seem like the church was living

what it preached. Those years I skipped Lenten and Holy Week services completely, going on Easter only if family was around with their expectations that I should attend.

What I don't remember a lot of, unfortunately, is an emphasis on the Easter season—those weeks following Easter. It was as if Easter was all over, and now we could concentrate on things like Mother's Day, weddings or upcoming graduation events and parties. I don't remember much of an effort to live as though the Resurrection and the promise of new life had all that much meaning.

It is my hope that this year during the Easter season we live into what it is to be Jesus people of hope and new life. We have an opportunity the very first weekend after Easter when the kids of the FaithWorks congregations continue a campaign to help address the issues of hunger. During Lent they were part of a "friendly competition" collecting money to be distributed to the food ministries we support in Racine. These young people are joining

→ Please turn to Page 19

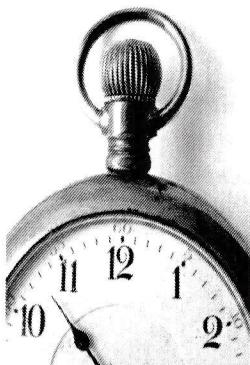

→ Continued from page 18

together at Atonement Lutheran Church on Friday, April 5 for a 30-Hour Famine Lock-In. All of us are invited to fast for those same 30 hours, to contribute to the food ministries, and to support these life-giving efforts in prayer.

This Easter season, let's look ahead. Let's bring the message and hope of new life to the world around us. Let's celebrate and

show those in our midst that the Resurrection *does* make a difference and that we are a part of that Good News! Let's practice what we preach!

Celebrating the Resurrected Christ,

Pastor Mary
Pastor Mary

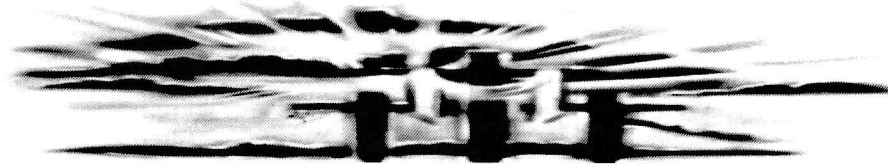

Lydia Circle Bible Study Meets April 10

The regular gathering for the women's Bible study, coffee and conversation will be



held the second Wednesday in April. All women are invited to the April 10 study led by Pastor Mary at 1:30 p.m. in the Sunset Room.

Holocaust Survivor Speaks at Rondelle

The S. C. Johnson Golden Rondelle Theater, 1525 Howe Street, invites the community to hear Halina Peabody, Holocaust survivor. Ms. Peabody will tell her powerful & moving story of suffering, loss & survival Monday, April 8 from 6:30

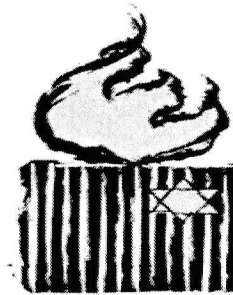

p.m. to 7:30 p.m.
Doors open at 6:00 p.m.

RSVP to
www.scjohnson.com
/visit under
"Schedule Your
Tour," or call 262-
260-2154

In the April Visitors:

- ✝ **Movie Time**
- ✝ **FaithWorks Easter Vigil**
- ✝ **Easter Services**
- ✝ **Fiesta Mexicana**
- ✝ **EASY Program**
- Readies for Spring**
- ✝ **Prayer Walk**
- ✝ **Community Meal**
- ✝ **Disposing of Old Medications**
- ✝ **Yesterday, Today, and Tomorrow**
- ... no fooling!

Emmaus Evangelical Lutheran Church
1925 Summit Avenue
Racine, Wisconsin 53404-2374

Change service requested

Non-Profit Org.
U.S. Postage PAID
Racine, WI
Permit No. 137

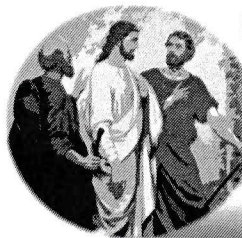

Emmaus Visitor

May, 2013

Congregation Weighs Budget June 23

A semi-annual congregational meeting has been set for Sunday, June 23, at 10:45 a.m. in the Sunset Room. Finances will be reviewed, and there will be a decision made regarding the budget for July

through December. There will be a report regarding progress in the work being done by the various FaithWork teams, and there will be an opportunity to ask questions and voice concerns.

Come to Fiesta Mexicana for Food, Fun

Tickets are now on sale for the meal and raffles for the Emmaus/Emaús May 18 Fiesta Mexicana. Join your Emmaus family for authentic Mexican cuisine prepared by the members of Emaús! These aren't your grandma's tamales...all entrees item will be home made and absolutely delicious!

There will be baskets for raffle, blind raffle and of course our two big raffle items this year are an iPad mini and \$500.00 cash! Come and enjoy the atmosphere, music and fun at Emmaus Lutheran (1925

Summit Avenue, Racine). Tickets can be purchased ahead of time or at the door.



In addition to a full fare of Mexican food and the raffled prizes, guests will enjoy special live Mexican music at various times throughout the day. Doors open at 11:00 a.m. Saturday, May 18, and the meal will be offered until 5:00 p.m. If you have any questions please contact Stacy Steinike 262-902-1842 or Melissa Lemke 262-994-8943. Look forward to seeing you there!

Emmaus Evangelical Lutheran Church
"Sent Forth by God's Blessing"
e-mail: emmausracine@sbcglobal.net
<http://www.emmaus-racine.org>

1925 Summit Avenue
Racine, Wisconsin 53404
Phone: 262 634-5515
Fax 262 634-0835

Pastoral Acts

Baptisms: Scarlett Rose Clinton April 7, 2013	Scarlett is the daughter of Ryan and Caley Clinton, and granddaughter of Jeff and Linda Clinton. Her sponsors are Emily Stang and Andrzej Pease.
Collin Thomas Nielsen April 7, 2013	Collin is the 2-year-old son of Brett and Julie Nielsen, and a nephew of Rev. Marcy Wieties. His sponsors are Michael & Debbie Braun.
Manuel J.R. Martinez April 14, 2013	Manuel is the son of Nina Davis and Manuel Martinez Jr. His sponsor is Danny.
Kaiyd Elijah Cardenas April 14, 2013	Kaiyd is the son of Amy and Fernando Cardenas and grandson of Bill and Linda Meteyard. His sponsors are Jason and Amanda Meteyard.
Aiden Ole D'Alie April 28, 2013	Aiden is the son of Amber and Anthony D'Alie of Burlington. His sponsors are Stephanie Olejniczak and Dan Azarian.
Funerals: Al Beck April 3, 2013	WWII veteran, retired teacher and fervent Yankee fan Al Beck died on March 30 at age 92. He loved gardening, travel, and photography, sharing his vacation photos with senior citizens' groups around town. At Emmaus, he was usher, greeter, and newsletter assembly helper. He is survived by June, his bride of 65 years; children Angela (Herbert) Henning, Steven (Hiroko) Beck, LuAnn (Douglas) Andreasen; seven grandchildren and eight great-grandchildren, other relatives and friends.
Silverio Gutiérrez Alarcón April 4, 2013	Mr. Gutiérrez was the owner of Silverio's Restaurant for over 50 years until his retirement in 1996. Survivors include sons Javier and Silverio Jr., daughters Erika Gutiérrez, Sendi (Jose) Contreras, Julissa Jaramillo, Norma Gutiérrez, Vanessa (Leon) Reyes, and Maria Elena (John) Escobar, 26 grandchildren and three great grandchildren.

Service of Prayer for Healing Slated May 4, 5

The worship services at 5:00 p.m. May 4 and 9:15 a.m. May 5 will offer prayers for healing,

laying on of hands and anointing with oil for those who desire.

Please Keep These in Your Prayers

Pastor Walter Hermanns' father, Edward, died in New York on Maundy Thursday at age 93. Pastor Walter was not able to attend his father's funeral in person due to pneumonia, but he and Lynn were able to be present by video and in

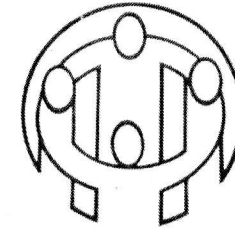

spirit. Please keep Pastor Walter in your prayers as he continues to recover.

Dorothy Bagley's brother Carl Borchardt passed away in March; his funeral service took place in Appleton on Maundy Thursday.

Women's Bible Study Changed to May 1

The May bible study and discussion for women will take place the first Wednesday of the month. This change has been made to accommodate Pastor

Mary's schedule. She will lead the May 1 study at 1:30 p.m. in the Sunset Room. All women are welcome!

Emmaus Staff & Worship Times

Church: 1925 Summit Avenue, Racine, Wisconsin 53404-2374.
emmausracine@sbcglobal.net ☎ 262 634-5515

Pastor:	Rev. Mary L. Janz	mljanz@aol.com	633-3059	ext. 201
	Rev. Jhon Freddy Correa	jhoncorrea@hotmail.com	414-881-1403	ext. 202
Church office:	Paul Berge	emmausracine@sbcglobal.net		ext. 200
Education Coord.:	Nancy Smith	nnsdaisy@aol.com		ext. 204
Outreach Coord.:	Liliana Moncada	liliana.moncada@hotmail.net		ext. 203
Council President:	Chris Lamberton	Accompanist:	Brenda Trumbauer	
Custodians:	Antelmo Hernando & Rich Benson			

English language services are held at Emmaus every Saturday evening at 5:00, and Sunday mornings at 9:15. Spanish language worship services are offered Sundays at noon.

Emmaus office hours are 9:00 a.m. to 3:00 p.m. Monday through Friday.

The VISITOR is published monthly September to July. The deadline for the June VISITOR is May 15. Submit articles to Paul Berge's attention by mail or by e-mail.

Quilter to Speak at Auxiliary Luncheon

The Lincoln Lutheran Auxiliary will have their spring luncheon at Lutheran Church of the Resurrection, 322 Ohio Street, at noon on Monday, May 20. Featured speaker Betty Ekern Suiter became the ninth person certified as Master Quilter by the National Quilting Association and named one of 30 Distinguished Quilt Artists of the World. She will

tell her story and show some of her quilts.

You do not have to be an Auxiliary member to attend. To purchase a ticket, please send a check payable to Lincoln Lutheran Auxiliary for \$8.50 to Laurie Zeh, 7007 Bobolink Road, Racine, 53402. Reservation deadline is Thursday, May 16; ticket pick-up is at the door.



Fleece Blankets Abound

Thanks to a very generous gift of yards and yards and yards of colorful fleece by Shirley Velzka's friend Alice Hoaglund, Emmaus women have been kept very busy for many Mondays in the creation of fleece blankets. Each blanket is hand tied and has a pattern on one side with a solid

color on the other. The fun, cozy blankets will be used as raffle prizes and as part of gift baskets for the May 18 Fiesta Mexicana fundraiser. Those interested in helping create the Fiesta baskets are invited to join the women in Fellowship Hall the mornings of May 6 and 13.

Communion Class Decorates Chalices

Four young people recently spent an afternoon at a local ceramics business in mid-April as they painted and decorated chalices designated for their First Communion. Two of the

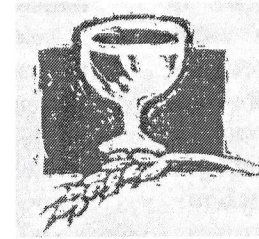

four girls who have been studying with Pastor Mary on a weekly basis will celebrate their special day on Pentecost Sunday, May 19. They are McKenzie and Madelyn Vash.

We Want to Recognize Graduates

We would like to recognize our high school and college graduates in the June *Visitor*. If you are graduating this spring (or were graduated this past winter or fall),

please call, e-mail the church office at emmausracine@sbcglobal.net, or send mail to Paul's attention at 1925 Summit Avenue, Racine, 53404.

Neighborhood Camp Registration Opens May 6

Registration for Neighborhood Camp will begin May 6. Those who have attended camp in the past will have the opportunity to register by May 19. New campers who register before May 16 will be put on a waiting list and invited to attend camp after May 20. Those interested in volunteering will be asked to complete a form and sign a

contract regarding the expectations for their involvement during the summer.



Camp is offered to those who live in the neighborhood; to those who attend EASY and Wednesday Night study; and to those who are

Emmaus members. Registration forms will be available in the narthex and outside of Nancy's office.

EASY Presents Closing Program

The students and staff of Emmaus After School for Youth will present the closing program for the 2012-13 school year Wednesday, May 15.

The evening begins at 5:30 p.m. with dinner followed by a

hands-on science fair at 6:30 p.m. A brief program will take place in the sanctuary at 7:00 p.m. One of the highlights will be a slide show of the year's events. The kids have worked hard with homework, and many enrichment activities.

Emmaus Kids Celebrate Día del Niño

Emmaus's Latino congregation observed Día del Niño (Day of the Child) at the noon worship service on Sunday, April 21. The Aztec dancers dressed up as clowns, and the children played games and batted at a piñata.

The United Nations established



Day of the Child in 1954. While many countries observe the U.N. Day of the Child on November 20, Mexico officially celebrates it on April 30. Parents give presents to their children, and schools conduct activities to commemorate the day.

Emmaus Visitor ✧ May, 2013

✧ Page 6

Churches Raise \$1,671 for Food Ministries

The "friendly competition" among the FaithWorks congregations filled jars with coins and bills, contributing to the combating of hunger in our community. As a part of the 30 Hour Famine, which was organized for the FaithWorks youth, the collections were made throughout Lent.

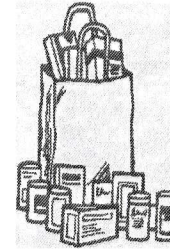

A total of \$1,671.05 has been deposited to the FaithWorks account, and decisions will be made by the FaithWorks mission council and youth leaders regarding the disbursal of the funds to the various food ministries supported by FaithWorks which include: Northside Food Pantry, Our Savior's community meal, Pan del Cielo, St. Pat's Community meal and Our Savior's Food pantry.

North Side Food Pantry Schedule

May 23: Pat & Ron Jensen, James Larrabee, Boots LeRoux

June 27: June Beck, Cheryl Dexter, Karen Sedgwick, Dianne Melander

Campus Ministry Welcomes Freshman Class

Do you know a student in higher education? Lutheran

Campus Ministry is on campus to help your young adults as they attend colleges, trade schools

and universities. Please share their name, contact information and which institution they will be attending with your pastor or send it to the campus ministry at UW-Madison (www.lccmadison.org). The Lutheran Campus Ministry will distribute the names to the

appropriate Wisconsin campus ministry. Email them to lccoffice@tds.net or mail to 325 N. Mills, Madison, WI 53715.



Youth Birthdays

- May 4 Kaylee Trevino, 4
- May 9 Elias Orozco, 7
- May 10 Selina Rodriguez, 18
- May 11 Alexis Christensen, 15
- May 14 Ella Briere, 6
- May 21 Jayanah Montes, 6
- May 24 Ashley Villalobos, 14
- May 25 Alex Zavala, 6
- May 25 Julian Rodriguez, 10
- May 26 Cesar Herrera-Saucedo, 7

Emmaus Visitor ✧ May, 2013 ✧ Page 7

Thank You to Community Meal Helpers

On April 4 Emmaus prepared and served the Community Meal at St. Patrick's Church. Thank you so much to all who helped out. It is good to see so many willing to help



out those who are in need.

Our next scheduled date at St. Pat's is Thursday, June 6. Watch for a new sign-up sheet in the narthex this month.

Thanks to Johnson Family for Easter Breakfast

The memory of Betty Johnson was honored by her family sponsoring the brunch which was served between the two Easter worship services. Thanks go to Danny Johnson and family, along with chef Manuel Gallardo, for

donating the food and food preparation for the Easter brunch.

Betty passed away two years ago on Easter Sunday, and the gathering of folks Easter Sunday, coming from many walks of life, would have been something she would have celebrated.

Help Needed with Campers' Meals

Emmaus Neighborhood Camp will take place from Monday, July 1 through Thursday, August 1. There will be no camp the week of July 4. The hours for camp are Monday through Thursday from 9:00 a.m. to 3:00 p.m.

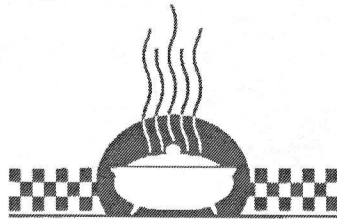

kids have great appetites. Wanted: food engineers.

You can help in the following ways:

- Provide cookies, bars, or other dessert items
- Serve breakfast
- Help prepare and/or serve noon meals

An important part of camp revolves around food. We strive to serve the campers healthy breakfasts, lunches and snacks. You have been an integral part of serving nutritious meals. Yes, the

Again this year, there will be a kitchen coordinator who will do menu planning and food shopping. Contact Liliana at 414-881-1491 and ask how you can help.

Water, Water Everywhere!

The torrential rains during the past month have caused leaks and water damage in several areas of the church. Serious leakage has occurred in the office areas, and many of the water soaked ceiling tiles have been removed. The water has also made its way through the ceiling area where the Sunset Room joins the first floor kitchen area. Another

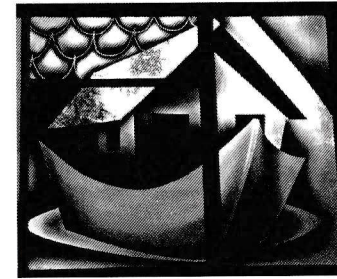

area that has been affected is in the area around the landing above the main entrance to the church. Water has historically found its way through the area where the steeple is attached to the roof.

While there was a small insurance settlement for some of the office damage (just under \$2,000), that amount will not be

sufficient to resolve the ongoing issues throughout the church. Loren Larsen has begun consulting with contractors for their suggested

solutions and quotes. The church council will discuss proposals for a plan of action and for potential sources of funding as soon as the needed information is made available.

Marcano Lends Hand to Latino Ministry

Venezuelan native Gabriel Marcano, has committed to spending time working with the Emaús Latino ministry three days a week for three months. A certified secondary teacher and an Anglican priest from Venezuela, Gabriel is currently spending time in Milwaukee studying English at MATC. During these studies and his time at Emaús, he is also discerning whether he will make a move from the Anglican to the ELCA Lutheran faith tradition.



Under the supervision and mentorship of Pastor Jhon Freddy, Gabriel has taken some leadership in small groups, has assisted with Sunday worship and also participated in the Gamaliel training for clergy the end of April. Should he choose to be a part of the ELCA, he would then need to be recommended to be part of the ELCA Candidacy process, which involves Synod staff and committee members.

We welcome Gabriel to this important part of his faith journey!

June Offering Envelopes Are Here

Offering envelopes for June, July, August and September have arrived at church. As a cost

control measure, we ask that you pick up your envelopes at church if at all possible.

Income Lags Behind Spending

It was reported at the April church council meeting that our current deficit stands at slightly over \$16,000. Of that amount, \$4,000 is what has not yet been paid for our commitment to benevolence to the greater church. Additionally, \$6,000 has been borrowed internally from the payroll account for Latino ministries.

In a giving analysis, Treasurer Art Smith has determined that 70% of givers are behind their giving level of a year ago. Among those who have pledged, a number of households

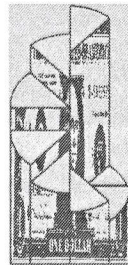

are not up-to-date in their commitments. An additional difference, when comparing to a year ago, is that we are no longer receiving revenue from working concession stands at the baseball games. It is hoped that proceeds from the Fiesta Mexicana on May 18 will help alleviate some of the shortfall. All monies earned through the Fiesta fundraiser will go to the general fund of the church. Members who are behind in their giving are encouraged to catch up with their commitments wherever possible.

Crunching the Numbers

Weekly worship attendance averages (calculated as of April 21, 2013)

	2011				2012				2013			
	Sat	Sun	Dom	Wed	Sat	Sun	Dom	Wed	Sat	Sun	Dom	Wed
Mar	14	61	167	45	17	54	189	14	13	70	165	288
Apr	21	113	204	93	17	71	205	236	13	65	160	
May	20	69	184	83	10	53	142					
Easter	9:15	11a	noon		9:15	noon			9:15	noon		
	139	100	274		134	243			131	225		

Financial Figures

General Fund offerings received in Mar. 2013 \$12,995.52 }

+ Lent, Easter: \$756.00 } \$33,661.18

Mortgage retirement offerings received in Mar. '13 \$120.00 Campaign TD: \$72,142.62
Principal balance as of April 13, 2013: \$28,809.32

May Birthdays: 70 Years and Better

May 5	Carolyn Wooster	4825 Indian Hills Drive	53406
May 8	Bill Irvine	5119 Valley Drive	53402
May 9	Ruth Estep	2522 Maple Grove Avenue	53404
May 9	Jim Simonsen	2939 Hayes Avenue	53405
May 11	Ray Rommelfaenger	2513 Jean Avenue	53404
May 17	Janet Thomsen	3296 Backridge Road, Woodlawn TN	37191
May 20	Marjorie Zielke	3121 Walden Way	53405
May 23	John Psiones Vet. Ctr., Boland Bldg.,	21425G Spring, UGrv.	53182
May 28	Diane Melander	1315 Isabelle Avenue	53402

May Worship Leaders





	Altar Guild	HC Assts.	Readers	Ushers
Sat. May 4 5:00 pm	Marge & Amy Zielke, M. Porcaro	—	—	—
Sun. May 5 9:15 am	Grace Falaschi	Carol Eschmann	John Knuteson	Team 1
Sat. May 11 5:00 pm	Barb & Jamie Toslek	—	—	—
Sun. May 12 9:15 am	Barb Larsen Pat Jensen	Pat Jensen Cindi Larsen	Jim Larrabee	Team 3
Sat. May 18 5:00 pm	Cheryl Dexter Shirley Irvine	—	—	—
Sun. May 19 9:15 am	Joy Lippmann Marge Jensen	Shirley Velzka	Amy Haman	Team 2 R. Christensen
Sat. May 25 5:00 pm	Brian & Denise Keller	—	—	—
Sun. May 26 9:15 am	Caren Lamberton	Joy Lippmann Kathy Christensen	Ron Jensen	Team 4 W. Meteyard
Sat. June 1 5:00 pm	Judy Berndt Linda Meteyard	—	—	—
Sun. June 2 9:15 am	Bev Hansen Audrey Villalobos	Nancy Smith	Cindi Larsen	Team 5 M. Porcaro

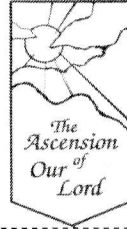

Coffee Fellowship

Fellowship Hosts

May 5: Chris & Caren Lamberton
May 12: Melissa Lemke & Stacy Steinike
May 19: Missy Porcaro, Amy & Marjorie Zielke
May 26: Audrey: Ashley's birthday
Emmaus Visitor ❖ May, 2013 ❖ Page 11

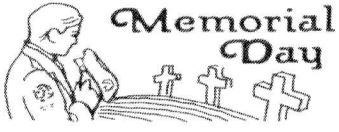
Sunday	Monday	Tuesday	Wednesday	Thursday	Friday	Saturday
	Emmaus Evangelical Lutheran Church 1925 Summit Avenue Racine, Wisconsin 53404-2374 Phone 262 634 5515; fax 262634-0835 Email: emmausracine@sbcglobal.net http://www.emmausracine.wordpress.com		1 ST. PHILIP & ST. JAMES 1:30 pm Lydia Circle 3:00 pm EASY 5:30 pm Supper 6:15 pm Classes	2 3:00 pm EASY 4:00 pm BENNU legal appointments 6:00 pm Ensayo del coro 7:00 pm FaithWorks at Atonement	3	4 STAR WARS DAY 5:00 pm Worship service with prayers for healing and Holy Communion (English)
5 6 TH SUNDAY OF EASTER; CINCO DE MAYO 9:15 am Worship service w/prayer for healing, Holy Communion (English) 10:30 am Coffee & fellowship 12:00 pm Santa misa (español) 12:30 pm Youth group (bilingual)	6 <i>Neighborhood Camp registration open to returning campers</i> 10:00 am Knit One, Purl One 3:00 pm EASY 6:00 pm Coach group (español)	7 3:00 pm EASY 5:00 pm TOPS 6:00 pm GED class	8 9:00 am WCATY 3:00 pm EASY 5:30 pm Supper 6:15 pm Classes	9 ASCENSION OF OUR LORD 3:00 pm EASY 6:00 pm Ensayo del coro 	10	11 1:00 pm J. Garcia baptism 5:00 pm Worship service w/HC (English)
----- <i>Pastor Mary's week off</i> -----						
12 7 TH SUNDAY OF EASTER; MOTHERS' DAY 9:15 am Worship service w/HC (English) 10:30 am Coffee & fellowship 12:00 pm Santa misa (español) 12:30 pm Youth group (bilingual) 	13 10:00 am Knit One, Purl One 3:00 pm EASY 6:00 pm Coach group (español)	14 ST. MATHIAS 3:00 pm EASY 5:00 pm TOPS 6:00 pm GED class	15 SHAVUOT June <i>Visitor</i> articles needed 3:00 pm EASY 5:30 pm Supper 6:30 pm EASY exhibit 7:00 pm Closing program	16 11:00 am Sunday bulletin deadline 4:00 pm BENNU legal appointments 6:00 pm Ensayo del coro	17 SYTTENDE MAI 	18 ARMED FORCES DAY 11:00 am Fiesta Mexicana, to 5:00 4:30 pm Worship service at St. Andrew LC 5:30 pm Karla Joanna Arce
19 PENTECOST 8:00 am Musicians' rehearsal (English) 9:15 am Chicago Folk service with First Communion (English) 10:30 am Coffee & fellowship 12:00 pm Santa misa (español) 12:30 pm Youth group (bilingual)	20 DAY OF PRAYER FOR MIDEAST PEACE <i>Neighborhood Camp registration opens to new campers</i> 10:00 am Knit One, Purl One 6:00 pm Coach group (español)	21 5:00 pm TOPS 6:00 pm GED class 6:30 pm Church council	22 	23 11:00 am Sunday bulletin deadline 6:00 pm Ensayo del coro	24	25 5:00 pm Worship service with Holy Communion (English)
26 TRINITY SUNDAY 9:15 am Worship service w/HC (English) 10:30 am Coffee & fellowship 12:00 pm Santa misa (español) 12:30 pm Youth group (bilingual) 	27 MEMORIAL DAY <i>Offices closed</i> 6:00 pm Coach group (español) 	28 5:00 pm TOPS 6:00 pm GED class 7:00 pm Fireside Exchange	29 11:30 am Worship & Music committee	30 11:00 am Sunday bulletin deadline 3:30 pm Synod Assembly, Waukesha 4:00 pm BENNU legal appointments 6:00 pm Ensayo del coro	31 8:00 am Synod Assembly, Waukesha	June 1 8:00 am Synod Assembly, Waukesha 5:00 pm Worship service with Holy Communion (English)

Thanksgiving Came in April

By Laura Bernett

A very special and most sincere thank you to all the wonderful Emmaus friends who pitched in to make turkey dinner for EASY on Wednesday, April 17 a huge success.

You are wonderful and I so appreciate each and every one of you and your many goodnesses.

The turkey was delicious with special thanks to official carvers Cheryl Dexter and Lee Woodward, Brenda Trumbauer for her weekly supply of yummy desserts, and Nancy Posadas for being my right hand / Cheryl – left hand – Rich Benson, Sandi Strini, Cindi Larsen, Carolyn

Wooster and her daughter Jodi, Sam and others.

A job well done – couldn't have done it without you.



Blessings and thank you!

Call me at 262-422-9544 if anyone can help future Wednesday evenings.

Remember Mom with Scrip

Need an idea for a Mothers' Day gift? We have a variety of gift cards on hand including various

restaurants, department stores and specialty stores. Check out the Scrip table after worship service.

Memorials & Honoraria

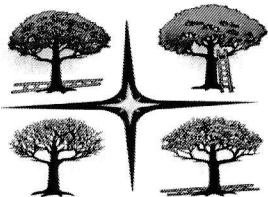

Non-designated memorials:

In memory of Dick Kluge: \$100.00

Designated for piano tuning:

In memory of Al Beck: \$125.00

Designation to be determined:

In memory of Al Beck \$3,660.00

Synod Assembly Meets May 30-June 1

The annual assembly of the Greater Milwaukee Synod will be held at May 30-June 1, 2013 at Country Springs Hotel/ Conference Center in Waukesha. The theme of this year's assembly is "Why?" Former Bishop Herb Chilstrom will address the assembly with opening remarks on



Thursday evening. A ministry fair, general business of the synod and other keynote speakers will be featured throughout the three-day event. Representing Emmaus/ Emaús will be Pastor Mary, Pastor Jhon Freddy and Cathy Meyer.

FaithWorks to Submit Grant Proposal to ELCA

The ongoing work of the FaithWorks congregations as we move forward in our vision of working together as a missional church has gained the attention of both synod and churchwide staff members. Pastor Sandy Chrostowski, ELCA Director for Evangelical Mission in the Greater Milwaukee Synod, has been working as a liaison, providing support, counsel and interpretation as the process unfolds. In addition, Dave Daubert represents the churchwide staff as he consults with and advises our Racine partnership.

The collaborative mission partnership of FaithWorks has led the ELCA to expand their categories for funding. The Racine FaithWorks leadership has been provided with forms for grant proposals, and we are being encouraged to submit a

preliminary request for funding by May 7. The FaithWorks grant committee (Pastor Warren Williams, Pastor Mary Janz, Liliana Moncada, Bob Reinders, Lou



Barrera and Jan Kasbeer) has met twice, and there will be further discussion regarding the initial proposal at the May 2 meeting of the FaithWorks council. Both Sandy Chrostowski and Dave Daubert will be present at that meeting.

FaithWorks Team to Form Action Plan

By Rev. Warren Williams

2013 is turning into a pivotal year for the FaithWorks partnership. We began the year with each FaithWorks congregation exploring what was central to their particular congregation so that the essence of each congregation could be communicated to the full partnership by way of videos that were shown at our common FaithWorks Lenten services.

Speaking of the Partnership Lenten Worship Journey, which moved us to each of the congregations for a meal, sharing and worship, there was general praise for the effort. The speakers and programs were great, the videos did provide a glimpse into the life of each congregation, and the food was great. It was wonderful to see the response. Our lowest attendance, at the far edge of a snowstorm, was 125, and most often attendance stayed in the 200 range. Everyone agreed it was fun to be in a big group for Lenten worship. What is more important is that by visiting each site, by sharing conversation with people not in our home congregations, and by seeing the great videos created for each congregation, we did grow to know each other better.

There have been several other things happening that are a bit more behind the scenes. First, the ELCA has assigned Dave Daubert, a church renewal guru, to help us on our FaithWorks journey. Dave has met with the FaithWorks pastors to advise and consult and will continue to walk with us on our journey. (Those who attended the FaithWorks retreat last fall may remember Dave.) The ELCA also sent Patricia Dever, a building consultant with the Mission

Investment Fund of the ELCA to walk through our buildings, and explore with us some of our facility strengths and weaknesses. Pastor Warren Williams from Atonement completed an asset mapping project, exploring the strengths and weaknesses of each congregation and seeking to find opportunities for new mission that can be undertaken by the partnership. Several of the FaithWorks pastors have also been exploring other partnerships around the country, which seem to be undertaking similar missional rebirth. In some ways they are ahead of us, in others behind, but we seek to find what has given them life and where they had missteps that we might avoid.

➔ Please turn to page 17

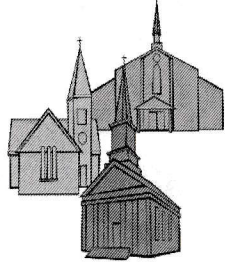

Dine and Donate Fat Tuesday Funds Received

Proceeds for the FaithWorks Dine and Donate program held at a local restaurant netted \$174.10. Thanks to all who came out to support our partnership with

Mardi Gras food and fun during that day! FaithWorks received 10% of what was sold to those who presented vouchers on behalf of the fundraiser.

FaithWorks Action Plan

➔ Continued from page 16

So where do we go from here? The next step in our journey of discovery is to discern the future of FaithWorks and how each congregation fits into the partnership. This spring, each congregation is charged with creating a comprehensive plan for the full partnership. The anticipation is that these plans will call for substantial missional change for each congregation, capitalizing on each congregation's strengths and focusing those strengths on our common mission. The biggest question each congregation is asked to prayerfully answer is "What is God calling our partnership to do to participate more fully in God's mission in Racine and beyond?"

At the same time those plans are being created we are completing an application for a grant to help fund FaithWorks. The ELCA has noticed us! Partnership seems to be one of the "new wineskins" that God is creating in the church to bless the world with God's love and justice.

FaithWorks appears to be a leader in this new way of being. In fact, the ELCA has created a new partnership grant, to some degree or another, for us. We need to have a strong application to fully take advantage of this opportunity.

This summer, the FaithWorks Mission Council will appoint a team of people to consider each of the congregations' plans for mission together and from those plans form a common vision and action plan to move FaithWorks to be the profound partnership that God has called us to be. That plan should be completed by late summer. At that point it will be communicated to each congregation and our members in a variety of ways. Each congregation will then be asked to ratify that plan - likely creating a new reality for each of us - in the fall and beyond.

Each congregation is to be praised for a spirit willing to journey into the unknown seeking first and finally to follow where our Lord leads.

Support Sustainable Forestry

by John Berge

The forests of the world have been called the lungs of the earth, but they work in the opposite direction from ours. They inhale carbon dioxide and exhale oxygen, reducing a major global warming gas and providing what is essential to our lives. So it is good environmental stewardship to do whatever we can to protect those forests. Here are two suggestions that seem as far apart as can be.



Are you flushing trees down the toilet? Our family has switched to Marcal small steps® toilet paper, manufactured by the Soundview Paper Company, and made from 100% recycled fibers. The company claims they are "Saving Millions of Trees with Recycled Fiber." I am sure there are other such recycled tissues out there that are equally soft and strong, but this is the brand that is carried where I shop.

On the other hand, there are paper companies that are cutting down the rain forests in Borneo, home of many endangered species, in order to make toilet paper! It would seem to be a simple choice.

When you buy furniture or lumber for a do-it-yourself project do you look for certification by the Forest Stewardship Council? The hardwood in that new table may

be imported from Siberia through China and harvested in an unsustainable way.

The World Wildlife Fund recently reported that "analysis of Russian customs data revealed that in 2010 the volume of Mongolian oak exported across the border to China was twice the amount actually authorized for logging in the region — a clear indicator that about half the Mongolian oak leaving the region was harvested illegally."

The answer is simple: "Purchase forest products certified by the Forest Stewardship Council (FSC)." The FSC mark on wooden furniture and lumber products means that the product meets FSC's rigorous environmental and social standards. "It comes from a responsibly managed forest, one which offers economic opportunity while protecting habitats and prey essential" for endangered species. The hardwoods, such as oak, ash and maple, may get the headlines, but the softwoods such as the various pines and firs used in construction and home projects are used in much larger volumes and so should be equally protected by the FSC mark. Forest use should be sustainable.

AUTHORIZATION FORM

The Simply Giving Program
endorsed by
Thrivent Financial Bank

FOR OFFICE USE ONLY	ENVELOPE/DONOR #	DATE
Emmaus Evangelical Lutheran Church		504744303
Effective date of authorization: ____/____/____		
Type of Authorization Form: <input type="checkbox"/> New Authorization <input type="checkbox"/> Change banking information <input type="checkbox"/> Change donation amount <input type="checkbox"/> Discontinue electronic donation <input type="checkbox"/> Change donation date		
Last Name		First Name
Address		
City		State Zip
Email Address		
FIRST DONATION DATE: ____/____/____	FREQUENCY OF DONATION: <input type="checkbox"/> Weekly on _____ <input type="checkbox"/> Monthly on _____ <input type="checkbox"/> Semi-Monthly (transferred on 1 st and 15 th of each month)	FUNDS AND AMOUNTS: <input type="checkbox"/> General Operating \$ _____ <input type="checkbox"/> Debt Retirement \$ _____ <input type="checkbox"/> Memorials _____ \$ _____ <input type="checkbox"/> Outreach _____ \$ _____ <input type="checkbox"/> Neighborhood Camp \$ _____ <input type="checkbox"/> Other _____ \$ _____
CHECKING / SAVINGS	Please debit my donation from my (check one): <input type="checkbox"/> Savings Account (contact your financial institution for Routing #) <input type="checkbox"/> Checking Account (attach a voided check below)	
	Routing Number: _____ Valid Routing # must start with 0, 1, 2, or 3 Account Number: _____ 	
I authorize the above church to process debit entries to my account. I understand that this authority will remain in effect until I provide reasonable notification to terminate the authorization.		
Authorized Signature: _____ Date: _____		
CREDIT CARD	Please charge my payments to my (check one): <input type="checkbox"/> Visa <input type="checkbox"/> MasterCard <input type="checkbox"/> American Express <input type="checkbox"/> Discover Card	
	Credit Card Number: _____	Expiration Date: _____
	Name on Card: _____	
	Billing Address (if different from above): _____	
I authorize the above church to charge my credit card in accordance with the information above.		
Signature (as it appears on the credit card): _____ Date: _____		

Diakonia Classes Return in Fall

diakonia™ provides systematic training to adults during a two-year program of weekly classes in Bible, theology and church history as well as practical ministry. This course of study, combined with spiritual retreats and group interaction, helps train people for the many diverse tasks and opportunities to fulfill their baptismal calling as servants of Christ.

Classes will run from September to May with locations in Oconomowoc, Milwaukee, and Kenosha. For more information contact Diane Roznowski, steering committee chair at diane.roznowski@gmail.com.

Application forms and financial aid forms can be found on the synod website at <http://milwaukesynod.org/what-we-do/education/diakonia/>

Detailed information about the courses can be found on the national diakonia website, thediakoniaprogram.org

Walk for Hopes Aids Homeless, Mentally Ill

Police Chief Art Howell will kick off the Third Walk for Hopes at 9:00 a.m. June 1. The Walk for Hopes is a fund raiser for Hopes



Center, a Racine Dominican sponsored ministry to provide counseling, case management, street outreach, and other services.

In addition to low-impact exercise (5-mile and 2.3-mile options), there will be music, door prizes, and more. For further information, call the Walk Coordinator at 262-898-2940, or visit them on line at <http://www.racinedominicans.org/HOPESCenter.cfm> and click on the Facebook link.

Outreach for Hope Sponsors September Ride

There is something for everyone at the Family Bike Ride on the Glacial Drumlin Trail near

Dousman to support the churches of the Greater Milwaukee Synod doing ministry among the poor in our Synod.

Please consider joining forces with hundreds of other bikers riding with a purpose at the Outreach For Hope Family Bike Ride. Visit the website often for updates:

<http://outreachforhope.org> (click on the bike ride link.) Registration begins on June 1, 2013.



Lincoln Lutheran Seeks Administrative Volunteer

Lincoln Lutheran is in need of a volunteer to help in its administrative offices at 2000 Domanik Drive. The person must be energetic and have a flexible schedule and be willing to commit two to four hours every week. While there is no monetary pay for this position, the reward comes with being a part of a team that helps change the lives of seniors in Racine County.

The person filling this position will serve as Volunteer Coordinator / Administrative

Assistant for the Agency Advancement Department. The person must be computer savvy and comfortable with new ideas and able to maintain confidentiality. To be considered for this position, please complete a volunteer application

which can be found at: www.lincolnlutheran.com/volunteer-opportunities.

Questions? Contact Melissa Greiner at (262) 898-2728 or mgreiner@llor.org



Rotary Invites Exchange Students

The Racine Area Rotary Clubs are looking for high school students who would like to spend 11 months overseas as a Rotary International High School Exchange Student. This would

mean spending 11 months in any one of more than 30 countries around the world starting August 15, 2014.

Students going will be selected by October 1, 2013. The student would live with a Rotary family while overseas.

The hosting foreign Rotary Clubs will provide the student with all school tuition and \$75 per month in spending money. The

student will pay for roundtrip airfare, additional spending money, fees for three orientation meetings, and health insurance while overseas. The student must be a current high school student. The student should have an outgoing personality and exhibit adaptability. Students who wish to apply, and their parent(s), will be interviewed to determine eligibility for the program and to provide information. No money is required at time of application. To obtain more information contact Timothy P. Crawford.

For further information, contact Timothy P. Crawford at 262634-6659.



Breaking New Ground

There's a newcomer in our neighborhood, and I recently offered to take her on a tour of Racine. We would have breakfast in a small coffee shop that also specializes in natural foods. We would drive by the lakefront, admiring some of the lakeshore homes as we were heading toward the famous Wind Point lighthouse. We would meander north to the Siena Center, then go to a garden store and eventually stop by Emmaus to see the upstairs murals and other parts of the building.

As a tour guide, I thought I knew our destinations well. After all, I had visited all of them many, many times. Much to my surprise, things had changed on Erie where we were about to turn in to the Siena Center. The sign now said Siena on the Lake. I had heard that that change was coming, but had not yet witnessed it. Then, there were the construction vehicles at the entrance almost blocking the torn up road. I knew construction was being planned, but it was the first time I had seen it. Next, as we approached the entry to the main chapel, I saw that there was now a



brand new wing to the north of that. I had earlier seen plans of what was being envisioned, but I was taken aback at the actual progress.

We drove to the back of the facility where the retreat center is still housed (apparently not for long, however). As we spent time in the bookstore and gift shop and as we walked the halls past the library, the prayer chapel, the looms, and the gathering rooms, I still sensed the peace and serenity I had always experienced when spending time there on retreat in years past. I still experienced the hospitality of the Dominican sisters who take such exquisite care of their facility.

Some things had changed while others were reassuringly familiar. I was struck at how the aging Dominican community has let go of what was, including the wing that housed the aging sisters who needed skilled nursing care. Pictured on the wall in one hallway were those sisters who now call home Lake Shore Manor, Becker Shoop, and other facilities.

➔ Please turn to page 23

Pastor Mary's Column

➔ Continued from page 22

Two entities (Lincoln Lutheran and the Siena Center), one Lutheran and one Roman Catholic, have come together for the sake of a greater vision. Siena on the Lake is happening because of forward thinking and a willingness to dream, to let go and to try something new for the sake of the greater Racine community. Because of a willingness of future residents wanting to invest in the creation of senior housing on the lake, pre-construction deposits are being made. Because of the needs of families who have a loved one needing special care at life's end, a portion of Becker Shoop has been repurposed to become Hospice House. Common needs and a common mission have brought new life and possibility, truly an

example of innovative and faith-filled people and partnership.

I thought to myself, after completing our half-day tour of some of my favorite places in Racine, "What might it look like to be a tour guide of our FaithWorks congregations just five years from now?" I pray that the work we are doing today will lead to even more creative and life giving ministries for the people of Racine in the future, and that we will see more glimpses of an answer to the prayer "Thy kingdom come, Thy will be done, on earth as it is in heaven."

In the hope of the risen Christ,

Pastor Mary
Pastor Mary

Bible Readings for May

May 5: Psalm 23; Ephesians 4:22-5:2; John 5:1-9.

May 9: Acts 1:1-11; Psalm 47 or 93; Ephesians 1:15-23; Luke 24:44-53.

May 12: Acts 16:16-34; Psalm 97; Revelation 22:12-14, 16-17, 20-21; John 17:20-26.

May 19: Acts 2:1-21 or Genesis 11:1-9, Psalm 104:24-34, 35b; Romans 8:14-17; John 14:8-17 [25-27].

May 26: Proverbs 8:1-4, 22-31; Psalm 8; Romans 5:1-5; John 16:12-15.

June 2: 1 Kings 8:22-23, 41-43 or 1 Kings 18:20-21 [22-29] 30-39; Psalm 96:1-9; Galatians 1:1-12; Luke 7:1-10.

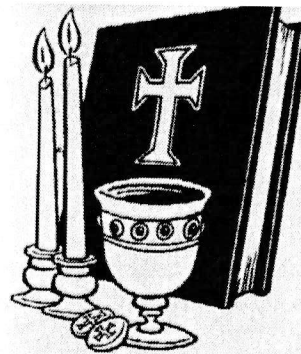

In the May Visitors:

- ✿ Budget Meeting
- ✿ Prayer for Healing
- ✿ Women's Bible Study
- ✿ Fleece Quilt Project
- ✿ First Communion
- ✿ Neighborhood Camp
- ✿ EASY Closing Dinner
- ✿ 30-Hour Famine Results
- ✿ It's Been a Wet Spring
- ✿ Gabriel Marcano
- ✿ Synod Assembly
- ✿ FaithWorks Action Plan
- ✿ Breaking New Ground

... and still more

Emmaus Evangelical Lutheran Church
1925 Summit Avenue
Racine, Wisconsin 53404-2374

Change service requested

Non-Profit Org.
U.S. Postage PAID
Racine, WI
Permit No. 137



Emmaus Visitor

June, 2013

Budget, FaithWorks to Be Topics at Congregational Meeting

The semi-annual congregational meeting will convene Sunday, June 23, at 10:45 a.m. in the Sunset Room. Treasurer Art Smith will present a review of our finances, and the council will recommend a budget for July through December.

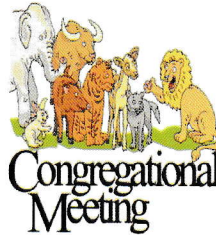

Emmaus's FaithWorks team members will present a report regarding progress in the work being done by the various FaithWorks teams, and will also respond to members' questions and concerns.

Youth Invited to Holy Hill Trip

Youth from the five FaithWorks congregations will gather for a day trip to Holy Hill on Saturday, June 15. The trip is open to youth in grades 6 to 12, and friends are welcome. We will do the stations of the cross outside in a wooded area.

Meet at the Ives Grove Park & Ride lot (one mile west of I-94 on Highway 20) at 10:45 a.m. Pack a

lunch; we'll have a picnic when we arrive at Holy Hill. Wear good walking shoes and bring bug spray and sunscreen if you need them. We plan to return to the Park & Ride at 4:00 p.m.

Contact Brenda Trumbauer at 681-3833 no later than June 9 to sign up. Adult drivers are also needed; please contact Brenda if you are interested.

Emmaus Evangelical Lutheran Church
"Sent Forth by God's Blessing"
e-mail: emmausracine@sbcglobal.net
<http://www.emmaus-racine.org>

1925 Summit Avenue
Racine, Wisconsin 53404
Phone: 262 634-5515
Fax 262 634-0835

Pastoral Acts

Baptisms: Jocelyn Isabel Garcia May 11, 2013	Jocelyn is the daughter of Maria Isabel & Elias Garcia; her sponsors are Serafin & Yesenia Maldonado.
Jaxon Samuel D'Alie May 26, 2013	Jaxon is the son of Brittani and Samuel D'Alie. His sponsors are Angela, RaeLin and Ole D'Alie.
Karla Joanna Arce May 18, 2013	Karla is the daughter of Maria and Juan Arce. Her sponsors are Eric Salazar and Elda Nuñez.
Funeral: Ella Marie Christiansen Nielsen April 27, 2013	Ella Nielsen, widow of J. Erik Nielsen, passed away peacefully at home on April 24, attended by her children, Ulla (Dave) Evans, Ib (Pat) Nielsen, Mary Ann Miller, Carl (Randi) Nielsen, Linda (Walter) Dahlke, Carol (Bill) Robuck, Julie Lynch and John (Carol) Nielsen.

Two Celebrate Their First Communion

Using chalices they had made themselves, Madelyn and McKenzie Vash came forward on Pentecost Sunday to receive their First Communion. The girls have completed Wednesday



communion classes with Pastor Mary. They were surrounded by godparents, parents and grandparents on this special occasion.

Memorials

Non-designated:

In memory of Al Beck: \$30.00

In memory of Ella Nielsen: \$1,030.00

Lydia Circle Meets June 12

The women's Bible study group will meet in the Sunset Room at 1:30 p.m. Wednesday,

June 12. This will be the last meeting before summer break.

Emmaus Visitor △ June, 2013 △ Page 2

EASY Kids Thank Their Mentors

Smiling faces, and enthusiastic hugs and handshakes--that was the scene during the closing program as, one by one, the EASY kids invited their mentors to come forward to receive a colorful potted flower. The kids so appreciated time spent with their mentor as together they worked on homework, math, vocabulary, reading and science projects. There was even time for conversation and games.

Thank you, Lou Barrera, Laura Bennett, Judy Berndt, Kathy Christensen, Valerie Crehan, Carol Eschmann, Jenn Haman, Kristi Kotleski, Caren Lamberton, Melissa Lemke, Cindi Larsen, Joy Lippmann, Diane Melander, Emily Papara, Missy Porcaro, Shelley Prudhom, Stacy Steinike, Art

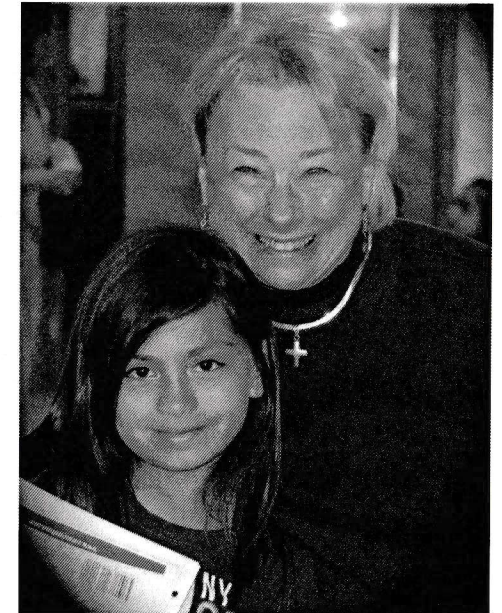

Smith, Sandi Strini, and Lee Woodward; we are truly blessed to have each of you in our midst.

Emmaus Staff & Worship Times

Church: 1925 Summit Avenue, Racine, Wisconsin 53404-2374.
emmausracine@sbcglobal.net ☎ 262 634-5515

Pastors: Rev. Mary L. Janz mljanz@aol.com 633-3059 ext. 201
Rev. Jhon Freddy Correa jhoncorrea@hotmail.com 414-881-1403 ext. 202
Church office: Paul Berge emmausracine@sbcglobal.net ext. 200
Education Coord.: Nancy Smith nnsdaisy@aol.com ext. 204
Outreach Coord.: Liliana Moncada liliana_moncada@hotmail.net ext. 203
Council President: Chris Lamberton Accompanist: Brenda Trumbauer
Custodians: Antelmo Hernando & Rich Benson

English language services are held at Emmaus Saturdays at 5:00 p.m. and Sundays at 9:15 a.m. Spanish language worship services are offered Sundays at noon.

Emmaus office hours are 9:00 a.m. to 3:00 p.m. Monday through Friday.

The VISITOR is published monthly September to July. The deadline for the July-August VISITOR is June 15. Submit articles to Paul Berge's attention by mail or by e-mail.

Emmaus Visitor

Vol. 41, No. 10
Page 3

June, 2013

EASY Celebrates a Great Year

Kids, parents, mentors, and friends together came together on the evening of May 15 for the after school program's year end picnic and program.

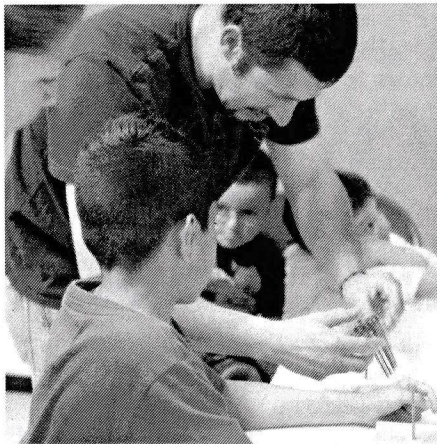

Fellowship Hall was buzzing with folks enjoying an indoor cookout. Burgers and hotdogs were supplemented with all the trimmings provided by the EASY families.

Hands-on-science gave all the opportunity to try the science projects the kids had done throughout the year. There was excitement as water spurted from the heart pump, dishes crashed to the floor as the tablecloth trick revealed that "you've got to be really fast if you want to pull the cloth out from under the dishes."

The sprinkler made out of straws and a skewer got people wet. Many went home with a baggie of homemade slime and a bag of tiny pearl-like beads that when put into water would grow into a marble size translucent orb.

Staff recognition was a highlight of the closing program.

Nancy Smith and Diane Thygeson did the brainstorming for the EASY curriculum. "Let's try it" was always the mantra for project ideas.

The year was fun and successful because of a dedicated group of young people: Andrea Macias, Jose Zuniga, Anthony Medina, Courtney Royster, Katie Syslack, and Marco Carbajal. A

special thanks to Laura Montoya, who stepped in midyear to lead our middle school youth, and to Brenda Trumbauer and Rich Benson.

The evening concluded with a slide show of the year, which was given to each EASY participant.

Youth Birthdays in June

- June 2 Paulina Rubio, 4
- June 8 Quinn Toslek, 2
- June 12 Christopher Mendez, 3
- June 16 Max Schultz, 1
- June 16 Ciara Williams, 15
- June 27 Cinthia Rubio, 11
- June 28 Mario Posadas, 13
- June 30 Christopher Cabrera, 2
- June 30 Tayshaun Carothers, 7

Artist in Residence Creates Mural

Have you noticed the newly painted scene on the wall just inside the south door?

Michael Macias, an eighth grade student who is quite talented with a brush, put his idea on paper and then on the wall. "God's Work, Our Hands", the ELCA Lutheran slogan, now greets all who enter Emmaus through the "circle" door. Michael has been part of

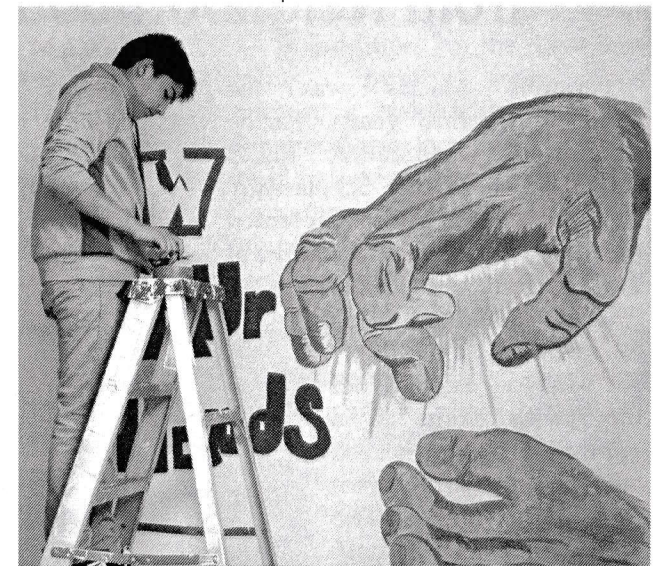

the Wednesday night middle school program.

Neighborhood Camp Begins July 1

Please note the dates for camp have been pushed ahead a week. This year the camp schedule is July 1 to August 1. We will need help in the kitchen for breakfast and lunch.

Themes for the summer have been selected:

- The Art of Peace
- Vanishing Act:
- Endangered Animals
- Electricity: Charged!
- ObSEUSSed: Wacky World in Seussville
- Civil War: Escape to Freedom

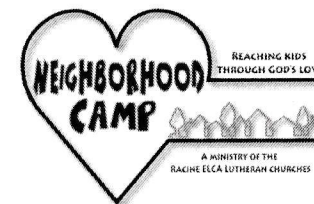

Please donate 2-liter bottles, microwave containers, toilet paper rolls. We can also use new #2 pencils and 9-V and size D batteries. If you find specials on Dr. Seuss books, our library could use a few more for our Dr. Seuss theme week. During our "Obsessed" week, it would be awesome to have volunteers read to the kids. Stay tuned for additional information about camp needs.

Andrea Macías Earns Scholarship from Neighborhood Camp

Andrea Macias was the recipient of this year's Racine Community Foundation ELCA Neighborhood Camp Scholarship. Art and Nancy Smith presented the \$1,000 scholarship to Andrea at the annual Horlick Awards Banquet at Roma Lodge on May 15.

Andrea began her time with camp as a volunteer. She has served on the camp staff the past three years and is also part of the EASY staff. Andrea has grown in her work with the children and communicates well with the parents and families of our kids.

Andrea will continue her education this fall at

Gateway. She has dreams of working in the criminal justice system, and she talks about the possibility of working with kids someday. Congratulations, Andrea!



Sunday Morning Church Isn't for Everyone

You probably know them: the family for whom worship has become next to impossible. They have a child with autism, a spouse with Alzheimer's, someone with severe hearing loss. Perhaps it's a person who feels self-conscious about their oxygen tank.

Whether we like it or not, these folks often feel like they are on the outside looking in. Gentle Worship

at Holy Communion Northwest Campus, 5040 Northwestern Ave., offers a worship service on the first Saturday of the month for families with individuals who are challenged by special needs or otherwise "on the edge." The casual, 30-minute service starts at 4:00 p.m., and features familiar songs as well as Holy Communion.

Siebert Awards Grant to Neighborhood Camp

The Siebert Lutheran Foundation continues to be a major funder for the Racine ELCA Neighborhood Camp. The grant proposal for \$35,000 in funding was approved. Additional grant monies totaling \$17,000 have been committed by the Outreach for Hope fund, which is an arm of the Greater Milwaukee Synod.

Verbal commitment has come from the RUSD office of Extended Day Programs to assist with the funding of SALT (Serving and Learning Together), the middle school component of Neighbor-

hood Camp.

In addition to the generous grants from organizations supporting Neighborhood Camp, donations of both time and money from individuals are essential for the camps to operate. Over 200 campers receive the opportunity to spend five weeks at one of the four sites, and the average cost to run the free camp per week for each of the campers is \$125. Donations may be made by check, payable to ELCA Neighborhood Camp, or by going to the Emmaus website and paying on line.

Fiesta Mexicana Exceeds Goals

Proceeds for the May 18 Fiesta Mexicana fundraiser surpassed goals set. Net proceeds for the day of food, music, silent auctions and raffles, has reached \$6,165, including \$1,600 in matching funds applied for from Thrivent Financial for Lutherans.

Many thanks to all who donated food, time, and hard work to make the Fiesta fundraiser such a success! Special thanks go

to sponsors Danny's Meats and Jose Blue Sombrero, who supplied most of the food served for the event—and most of all, to all who bought raffle tickets, bid on auction items and came to enjoy the food, music and fun in person!

All proceeds of the fundraiser will go to fund regular programming and operating costs included in the general budget of the church.



LUTHERAN DISASTER RESPONSE RESPONDING TO U.S. TORNADES

MAY 2013

www.ELCA.org/disaster

A two-mile-wide tornado ripped through Moore, Okla., claiming many lives and leaving behind a devastating trail of destruction. Plaza Towers Elementary School stood right in the path of the storm's 166-200 mph winds.

Many homes are damaged or destroyed as tornadoes touched down throughout Oklahoma, Kansas, Texas, Illinois and Iowa. As strong winds and warm fronts continue to move across the nation, the threat for future tornado outbreaks is looming.

Your help is needed to bring hope to our sisters and brothers in need. Lutheran Disaster Response affiliates are already on the ground, assessing

the immediate and long-term needs of those affected by the tornadoes. We already know it will be a long road to recovery, and your gifts are needed now to begin coordinating volunteers, rebuilding homes and offering spiritual and emotional care to those in need.

Gifts designated to "U.S. Tornadoes" through Lutheran Disaster Response will be used entirely – 100 percent – to help survivors of tornadoes rebuild their lives and livelihoods. Our church is reaching out in response to these devastating storms and assessing the needs – working together for as long as it takes. Thank you for your gifts, your prayers and your partnership.

Yes, I want to help!

- Lutheran Disaster Response: *U.S. Tornadoes* \$ _____ DDG0020
- Lutheran Disaster Response: *Where Needed Most* \$ _____ DDG0010

Name _____

Address _____

City _____ State _____ ZIP code _____

Email Address _____

Give through your congregation or send your check directly to:
Lutheran Disaster Response, 39330 Treasury Center, Chicago, IL 60694-9300
write "U.S. Tornadoes" or "Where Needed Most" on your check's memo line.



Evangelical Lutheran Church in America

God's work. Our hands.

June Worship Leaders

	Altar Guild	HC Assts.	Readers	Ushers
Sat. Jun. 1 5:00 pm	Judy Berndt Linda Meteyard	—	—	—
Sun. Jun. 2 9:15 am	Bev Hansen Audrey Villalobos	Nancy Smith	Kathy Christensen	Team 5 M. Porcaro
Sat. Jun. 8 5:00 pm	Cathy Meyer Linda Clinton	—	—	—
Sun. Jun. 9 9:15 am	Kathy Christensen Marlyn Christensen	Diane Melander Karen Sedgwick	Jen Haman	Team 2 R. Christensen
Sat. Jun. 15 5:00 pm	Marge & Amy Zielke Missy Porcaro	—	—	—
Sun. Jun. 16 9:15 am	Grace Falaschi	Chris Lamberton	Melissa Lemke	Team 1
Sat. Jun. 22 5:00 pm	Barb Toslek Jamie Toslek	—	—	—
Sun. Jun. 23 9:15 am	Caren Lamberton	Carol Eschmann Kathy Christensen	Lee Woodward	Team 3
Sat. Jun. 29 5:00 pm	Cheryl Dexter	—	—	—
Sun. Jun. 30 9:15 am	Barb Larsen Pat Jensen	Pat Jensen Joy Lippmann	Kathy Christensen	Team 5 M. Porcaro
Sat. July 6 5:00 pm	Marge & Amy Zielke Missy Porcaro	—	—	—
Sun. July 7 9:15 am	Bev Hansen Audrey Villalobos	Shirley Velzka	Nancy Smith	Team 4 W. Meteyard

Coffee Hour Hosts

June 2:
June 9: Loren & Cindi
Larsen
June 16: Svendsens

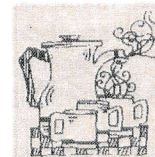

June 23: Cheryl Dexter & Carol
Eschmann
June 30: Laura Bennett & Pat
Jensen

Bible Readings in June

June 2: 1 Kings 8:22-23, 41-43; Psalm 96:1-9; Galatians 1:1-2; Luke 7:1-10.
June 9: 1 Kings 17:17-24; Psalm 30; Galatians 1:11-24; Luke 7:11-17.
June 16: 2 Samuel 11:26 – 12:10, 13-15; Psalm 32; Galatians 2:15-21.
June 23: Isaiah 65:1-9; Psalm 22:19-28; Galatians 3:23-29; Luke 8:26-39.
June 30: 1 Kings 19:15-16, 19-21; Psalm 16; Galatians 5:1, 1-25; Luke 9:51-62.

Sunday

Monday

Tuesday

Wednesday

Thursday

Friday

Saturday

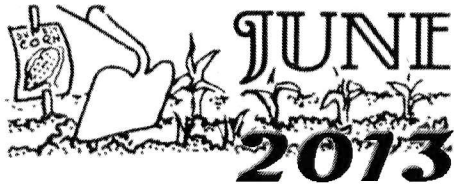

Emmaus Evangelical Lutheran Church

1925 Summit Avenue, Racine, Wisconsin 53404-2374

262 634-5515 ☒ emmausracine@sbcglobal.net http://www.emmaus-racine.org

May 30

3:30 pm Synod Assembly, Waukesha

31

8:00 am Synod Assembly

1

8:00 am Synod Assembly, Waukesha
5:00 pm Worship service
5:00 pm Toslek renewal of vows

2 2ND SUNDAY AFTER PENTECOST

7:15 am Paseo familiar en Brown's Lake
9:15 am Worship service with Holy Communion (English)
10:30 am Coffee & fellowship
12:30 pm Kids' Camp (bilingual)

3

4

5:00 pm TOPS
6:00 pm GED class

5

6

11:00 am Sunday bulletin deadline
5:00 pm Community Meal at St. Pat's
6:00 pm Ensayo de coro (español)

7

8

5:00 pm Worship service with Holy Communion (English)

Pastor Mary's week off

9 3RD SUNDAY AFTER PENTECOST

9:15 am Worship service with Holy Communion (English)
10:30 am Coffee & fellowship
12:00 pm Santa misa (español)
12:30 pm Kids' camp (bilingual)

10

11:30 am Worship & Music committee meeting
5:45 pm Q&A with law enforcement officials

11 ST. BARNABAS

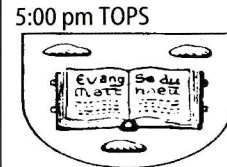

12

13

11:00 am Sunday bulletin deadline
4:00 pm BENNU legal appointments
6:00 pm GED class
6:00 pm Ensayo de coro

14 FLAG DAY



15

1:00 pm RIC Immigration Task Force
5:00 pm Worship service with Holy Communion

16 4TH SUN. AFTER PENTECOST; FATHERS' DAY

8:00 am Musicians' rehearsal
9:15 am Chicago Folk service with Holy Communion (English)
10:15 am Coffee & conversation
12:00 n Santa misa (español)
12:30 pm Kids' Camp (bilingual)

17

July-August Visitor articles due in office

18

5:00 pm TOPS
6:30 pm Church council

19 JUNETEENTH DAY

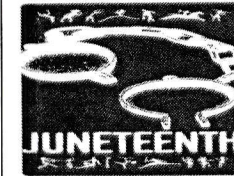

20 DAY OF PRAYER FOR PEACE IN MIDDLE EAST

11:00 am Weekend bulletin deadline
6:00 pm Ensayo de coro

21

22

10:00 am M. Martinez baptism
5:00 pm Worship service with Holy Communion (English)

23 5TH SUNDAY AFTER PENTECOST

9:15 am Worship service with Holy Communion (English)
10:30 am Coffee & fellowship
10:45 am Congregational meeting (English)
12:00 n Santa misa (español)
12:30 pm Kids' Camp (bilingual)

24 NATIVITY OF JOHN THE BAPTIST

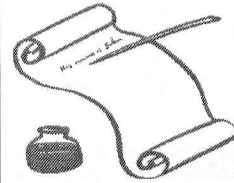

25

5:00 pm TOPS

26

9:00 am Neighborhood Camp staff training, to 2:00

27

9:00 am Neighborhood Camp staff training
11:00 am Sunday bulletin deadline
4:00 pm BENNU legal appointments
6:00 pm Ensayo de coro

28

9:00 am Neighborhood Camp staff training

29 ST. PETER & ST. PAUL

1:00 pm Ortiz quinceañera
5:00 pm Worship service with Holy Communion (English)

30 6TH SUNDAY AFTER PENTECOST

9:15 am Worship service with Holy Communion (English)
10:30 Coffee & fellowship
12:00 n Santa misa (español)
12:30 pm Kids' Camp (bilingual)

JULY 1 CANADA DAY

9:00 am Neighborhood Camp, to 3:00

2

9:00 am Neighborhood Camp
5:00 pm TOPS

3

9:00 am Neighborhood Camp
11:00 am Bulletin deadline

4 INDEPENDENCE DAY

Offices closed. No Neighborhood Camp

5



6

1:00 pm Oviedo quinceañera
5:00 pm Worship service with Holy Communion

Scrip Cards Make Swell Card Stuffers

Need a graduation or Father's Day gift? We have a variety of gift cards on hand, including various restaurants,

department stores, and specialty stores. Check out the Scrip table after worship service.

Marines Deploy Eric Larsen

Eric Larsen has been deployed to active service. Please remember him in your prayers; mail can be



sent to him at MAJOR E.H. LARSEN, MAG-50, MWCS-38, Unit 26031, FPO AP 96427-6031.

Thanks to Office Help

Thank you to all the people who volunteered to staff the church office while Paul was away at his nephew's wedding in May.

Paul is extremely grateful to Diane Melander, Art Smith, Liliana Moncada, Pastor Mary, and Cathy Meyer.

June Birthdays: 70 Years and Better

June 1	Marcie Runge	3920 N. Green Bay Road	53404
June 7	Jim Brown	1814 Mars Avenue	53404
June 10	Evelyn Larsen	3920 N. Green Bay Road # 74	53404
June 17	Mildred Schroth	244 N. Macy St., Fond du Lac	54935
June 19	Renate Doughty	1921 Arcturus Avenue	53404
June 21	Lee Woodward	2333 Arlington Avenue	53403
June 26	Rose Rommelfaenger	2513 Jean Avenue	53404
June 27	Al Svendsen	8500 Corporate Dr. #305	53406

Motion Sensors Added to Lighting

In an effort to cut down on energy costs, Rich Benson has installed motion sensors on some light switches in the church building. These rest room,

classroom and hallway lights are programmed to turn on when someone enters the area, and to turn off after a certain period of lack of activity.

Cluster Pools Assets for Food Ministries

By Rev. Dana O'Brien

Racine Mission Cluster met in April and elected Marge Puntarec as our lay female representative to the Synod Council. Congratulations Marge!

We heard a report from our treasurer, Bob Reinders. Bob has faithfully filled the role of Cluster Treasurer for some time and I want him to know how much we all appreciate it.

Sue Ruehle spoke about Pan de Cielo, and provided some general financial figures. This food program provides food for approximately 18-20



families who are unable to use the other food pantries in Racine. The cluster currently provides \$125 per month to support this ministry and we committed to continuing that monthly support through the remainder of this year.

I spoke briefly about our cluster-supported Community meal program at Our Savior's. That program served over 4000 guests in 2012 and provides much more than just a meal on Sunday night. Both Betty Kreckling and Chris Bahr, who coordinate the program, have taken a real interest in our guests, and their hospitality makes Sunday night meals look a

lot like a large family get-together. A number of churches in addition to those in our Racine ELCA cluster volunteer on Sunday evenings, and a couple of unaffiliated volunteers come on most Sundays.

We're doing something here with our support of Pan de Cielo and the Sunday Night Community Meal that I don't think any other clusters are doing. These two meal ministries meet a real need and make a positive difference in our Racine community. They demonstrate that together we have a much bigger impact than any one of us could alone.

(Think about it -- it would be really difficult for any one of us to staff and support our Sunday night meal program alone. But by pooling our assets and volunteers, we are making a big difference in the lives of those people served.) This type of community ministry is certainly something God is calling all of us to do.

We all agreed that these food programs are valuable and definitely something we want to continue. Note that we still need congregations to volunteer for the following Sundays: June 30, July 7, August 18 and December 22.

Emmaus Serves Community Meal June 6

Emmaus' next turn to serve the Community Meal at St. Patrick's Church is on Thursday June 6. We welcome volunteers to

help serve the food. The recipe for the casserole is posted at www.emmaus-racine.org/SociConc.html

NorthSide Food Pantry Schedule

June 27: June Beck, Cheryl Dexter, Karen Sedgwick, Dianne Melander
 July 25: Cindi Larsen, Marge Zielke, Boots LeRoux, Art Smith
 August 22: Kathy & Rich Christensen, Cheryl Dexter, Ron & Pat Jensen

Synod Assembly Meets in Waukesha

The annual assembly of the Greater Milwaukee Synod convenes May 30-June 1 at Country Springs Hotel and Conference Center in Waukesha. Representing Emmaus/ Emaús are Pastor Mary, Pastor Jhon Freddy and Cathy Meyer.



Agenda items include voting on resolutions addressing employment discrimination, refugee resettlement, and the sale of church properties that are no longer in use. Watch our weblog, emmausracine.wordpress.com, and weekend bulletins for updated reports.

Crunching the Numbers

Weekly worship attendance averages (calculated as of May 26, 2013)

	2011				2012				2013		
	Sat	Sun	Dom	Wed	Sat	Sun	Dom	Wed	Sat	Sun	Dom
Apr	21	113	204	93	15	70	205	143	13	61	150
May	20	69	184	83	10	53	142	n/a	15	63	150
Jun	16	50	171	n/a	13	48	143	n/a			

Financial Figures

General Fund offerings received in Mar. 2013 \$ 12,995.52 }
 + Lent, Easter and "special": \$ 756.00 } \$ 43,919.27

Mortgage retirement offerings received in Apr. '13.....	\$120.00.....	Campaign TD: \$72,632.62
Mortgage payments in April & May, 2013 ..	Principal: \$1,695.40	
	Interest: \$288.60	
	Total: \$1,984.00	
Principal balance as of May 14, 2013.....	\$27,963.77	June, 2013 * Page 14

Environmental Stewardship

Our Forests Protect Caribbean Coffee

by John Berge

Earlier this spring, I was privileged to see a beautiful American redstart flitting around in our backyard. The male redstart is a black warbler with brilliant orange patches on its wings and tail. It is a neotropical bird that nests and breeds over much of the eastern United States and winters in the Caribbean and Central America. This sighting was made more significant due to an article that I read a few days later.

This article told of the coffee berry borer, the bane of coffee farmers in Jamaica and elsewhere. The borer spends much of its life cycle inside the coffee bean as egg and larva, making the bean unsalable. There are no safe pesticides that can control the insect, which can infest up to 20% of a farmer's crop!

To the rescue comes the American redstart and other warblers such as the black-throated blue warbler. They are encouraged by planting of native shade trees which not only protect the coffee plants but provide warbler habitat. At one farm, studies have shown that the pest-control value of the redstarts and other warblers amounts to \$125 per acre, or about one-eighth of the total crop value of \$1,044 per acre.

So what can we do up here to help out these birds? Protect our native forests where the birds nest and breed, and hold down our pesticide use so that these birds have enough insects to feed themselves and their young.

In another article brought to my attention this past month, researchers at the Lincoln Park Zoo and Northern Illinois University have discovered one more reason to get rid of that invasive alien plant species, European buckthorn. Buckthorn produces the chemical compound emodin in its leaves, fruit, bark and roots.

Emodin is released into the transient pools and breeding ponds of amphibians; it is toxic to amphibian embryos, disrupting their development and preventing hatching. Since the highest levels of emodin in the environment is at leaf-out when many frogs are breeding, buckthorn is in all probability a contributing factor in the die-off and extermination of frogs and other amphibians.

Good environmental stewardship would be to remove all buckthorn from your property and to volunteer with groups who are removing it from parks and other public places.



Emmaus Hosts 'Sacred Conversations'

Emmaus will host „Sacred Conversations,“ sponsored by the Racine Interfaith Coalition (RIC)

Immigration Task Force, from 1:00 to 3:00 p.m. Saturday, June 15.

AUTHORIZATION FORM

The **Simply Giving** Program
endorsed by
Thrivent Financial Bank

FOR OFFICE USE ONLY		ENVELOPE/DONOR #	DATE
Emmaus Evangelical Lutheran Church		504744303	
Effective date of authorization: _____/_____/_____			
Type of Authorization Form:			
<input type="checkbox"/> New Authorization		<input type="checkbox"/> Change banking information	
<input type="checkbox"/> Change donation amount		<input type="checkbox"/> Discontinue electronic donation	
<input type="checkbox"/> Change donation date			
Last Name		First Name	
Address			
City		State	Zip
Email Address			
FIRST DONATION DATE: _____/_____/_____		FREQUENCY OF DONATION:	
		<input type="checkbox"/> Weekly on _____	
		<input type="checkbox"/> Monthly on _____	
		<input type="checkbox"/> Semi-Monthly (transferred on 1 st and 15 th of each month)	
		FUNDS AND AMOUNTS:	
		<input type="checkbox"/> General Operating \$ _____	
		<input type="checkbox"/> Debt Retirement \$ _____	
		<input type="checkbox"/> Memorials \$ _____	
		<input type="checkbox"/> Outreach \$ _____	
		<input type="checkbox"/> Neighborhood Camp \$ _____	
		<input type="checkbox"/> Other \$ _____	
CHECKING / SAVINGS	Please debit my donation from my (check one):		Routing Number: _____
	<input type="checkbox"/> Savings Account (contact your financial institution for Routing #)		Valid Routing # must start with 0, 1, 2, or 3
	<input type="checkbox"/> Checking Account (attach a voided check below)		Account Number: _____
I authorize the above church to process debit entries to my account. I understand that this authority will remain in effect until I provide reasonable notification to terminate the authorization.			
Authorized Signature: _____		Date: _____	
CREDIT CARD	Please charge my payments to my (check one): <input type="checkbox"/> Visa <input type="checkbox"/> MasterCard <input type="checkbox"/> American Express <input type="checkbox"/> Discover Card		
	Credit Card Number: _____		Expiration Date: _____
	Name on Card: _____		
	Billing Address (if different from above): _____		
	I authorize the above church to charge my credit card in accordance with the information above.		
Signature (as it appears on the credit card): _____		Date: _____	

Elsewhere in Our Area

Church Musicians Present Music Fest

Lutheran Church of the Resurrection will host Racine Interfaith Coalition's Third Music Fest at 3:00 p.m. Sunday, June 2. Musical groups from nine congregations will perform at this free concert, at 322 Ohio Street. For information, call the RIC office at 262635-9532.



ministry among the poor in our Synod.

Casual rider - including families and children - a ride on the paved Glacial Drumlin Trail, 14 miles or less if you prefer. Trail passes provided, if needed.

Avid bicyclist - either a 30 or 40 mile mapped and cued ride on country roads around Dousman.

Everyone - catered picnic at noon.

Non-bikers - opportunity to support Outreach for Hope with donations of any amount.

New this year:

Professional and friendly online registration

Online pledging

Improved ride signage

Rest station on the family trail ride

Upgrades for door prizes

Registration and more information is available at www.outreachforhope.org - look for the "Bike Ride" link.

Gethsemane Lutheran Celebrates Centennial

The youngest of Emmaus's daughter congregations, Gethsemane Evangelical Lutheran Church, will celebrate its 100th anniversary with afternoon events on Saturday, July 13 at Roma Lodge and a worship celebration at 10:10 a.m. Sunday, July 14. Everyone is invited to help celebrate.

Register for Outreach For Hope Bike Ride

There is something for everyone at the Family Bike Ride to support the churches of the Greater Milwaukee Synod doing



Investing in Our Future

I remember a number of years ago when a friend and I pooled a modest amount of "extra money" to invest in a stock that was related to the health field. We really knew nothing about the stock other than it had something to do with prosthetics and that it came highly recommended. Our goal was simply to grow our money so that we could take a nice vacation. We knew that even if the company in which we invested went "belly up," we would be okay. Fortunately, there was return on our meager investments, and we were able to take a couple of trips.

Not all pooling of resources and looking to the future needs to be done so whimsically or so self-centeredly. I know that there are many people who are fortunate to have finances and an estate that will have some remains to pass on, and they are taking this responsibility very seriously. Perhaps family members, favorite charities or a church will be the beneficiaries of a legacy gift that is passed on. Recently, Emmaus received a portion of the estate of Isabelle Barry, former member of the church. Her forethought, years

ago, is helping us today as we look ahead to the future.

How do we plan and build the church of tomorrow? How will we pass on the faith that has filled and sustained us as part of our church family? How do we promote the physical, emotional and spiritual wellbeing of our kids, grandkids, and all members of the community? What does relevant worship and an emphasis on wholeness and wellness look like as we envision a church that brings hope and transformation to our community?

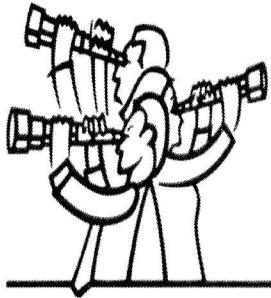

The FaithWorks congregations (Emmaus, St. Andrew, Our Savior's, Atonement and Redeemer) are asking those questions

together as we work on a common vision. We have submitted a grant proposal to the national office of the ELCA as a part of our area mission and ministry vision. In that proposal we have requested support for a new staff position (a Community Youth minister), and for funds to conduct the initial study and planning for a wholeness/wellness initiative, which would include all our congregations. Meanwhile, under the direction of consultant Susan Gould, the overall visioning

→ Please turn to page 19

→ Continued from page 18

process will continue to unfold during the summer.

Hundreds of hours of volunteer time have already gone into the FaithWorks process. Lay leaders and clergy are working tirelessly, convinced that we are stronger together than individually. I personally am donating a minimum of three days each month as my investment in this important endeavor to further God's mission in our community. We have had the investment of time and input of the Synod and churchwide staff, offering counsel throughout the process. And, community leaders from outside the circle of the ELCA are even beginning to step forward to offer their time or resources.

In addition to Emmaus sharing monetary support with the other FaithWorks congregations to finance Liliana Moncada as our half-time administrator (writing grants, organizing the Fall Festival, organizing the monthly Mission Council meetings, communications, finance, and much more), the Emmaus council is proposing an opportunity for individuals to invest financially in the FaithWorks vision. The idea grew out of a conversation of

women in the Lydia circle as they recalled their involvement in the loan program to help the "new addition" to the church over a quarter century ago. Now in 2013,



how might "faith shares" (either as gifts or as loans) be given as seed money for the future as part of our investment in FaithWorks? Can the FaithWorks congregations begin "Faith Funds" so that we can then pool our resources as we move ahead? Did you know that grantors and funders tend to be far more generous when they see evidence of a

sense of ownership and investment from those seeking the funding?

How are you ready to invest? We need prayers, memorials, bequests, one-time special gifts, volunteer time, more prayers...and a willingness to follow where the Holy Spirit may lead. What do you have to offer? If we are willing to invest, God will multiply our efforts beyond what we can even imagine!

Join me in being part of the vision as we invest in passing on the most important legacy possible—transformation, new life and wellbeing for ALL of God's children!

Pastor Mary

Pastor Mary

In the June Visitor

- Congregational Meeting June 23
- FaithWorks Youth Trip to Holy Hill
- EASY Year's End
- Neighborhood Camp Begins July 1
- Scholarship Award
- Fiesta Report
- Tornado Response
- Cluster, Synod Assemblies
- Investing in Our Future

Emmaus Evangelical Lutheran Church
1925 Summit Avenue
Racine, Wisconsin 53404-2374

Change service requested

Non-Profit Org.
U.S. Postage PAID
Racine, WI
Permit No. 137

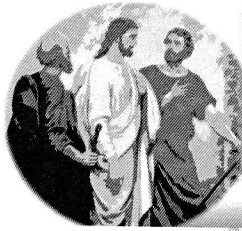

Emmaus Visitor

July-August, 2013



Large Crowd Attends Forum with Sheriff

Story on Page 3. Photo by K. Arlett Avz

Meet New Schools Superintendent

Dr. Lolli Haws has been named as the new Superintendent of Racine Unified School District and begins leading the school district July 1. Originally from

South Dakota, Dr. Haws has most recently been a school administrator in the Washington D.C. area.

→ Please turn to page 2

Emmaus Evangelical Lutheran Church
"Sent Forth by God's Blessing"
e-mail: emmausracine@sbcglobal.net
<http://emmausracine.wordpress.com>

1925 Summit Avenue
Racine, Wisconsin 53404
Phone: 262 634-5515
Fax 262 634-0835

Pastoral Acts

Baptisms:

Alexa Isabella Blancarte
June 15, 2013

Alexa is the daughter of Crystal Hernández and Guillermo Blancarte; her sponsors are Isidro & Delma Vieyra.

Dr. Lolli Haws

→ Continued from page 1

In an effort to listen to community needs and concerns and to meet people from the community, an number of "Meet and Greet" listening sessions have been arranged for Dr. Haws during the months of July and August.

Members and friends of Emmaus are invited to



the home of Art and Nancy Smith and Pastor Mary, 1530 Main Street, July 10 from 6:00 to 8:00 p.m. to meet Dr. Haws. If you are planning attend, please email mljanz@aol.com or leave a message with Paul, the church secretary, at 634-5515.

Help Fill Basket with School Supplies

Thanks to your support, many Wadewitz children received needed school supplies this past school year. Let's help make that possible again this year!

Look for a basket in the narthex in August where you can donate:

- spiral notebooks with wide lines

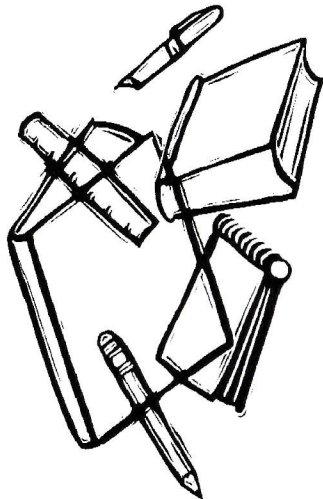

- new #2 pencils with erasers
- colored pocket folders
- glue sticks and regular Elmer's glue
- large pink school erasers
- crayons (boxes of 16 or more)
- rulers (with both inches and centimeters)
- boxes of watercolors with a brush

Over 400 Air Concerns with Sheriff

An estimated 400 people showed up for a public forum at Emmaus with Racine County Sheriff Christopher Schmaling and other law enforcement officials. Thanks to cooperation from the weather, we were able to hold the forum outside on the lawn to accommodate such a large crowd.

The Racine Journal Times ran their coverage of the event across the front page; Caledonia Patch.com also highlighted their coverage of the forum. Mayor John Dickert and Racine Police Chief Art Howell also attended the forum.

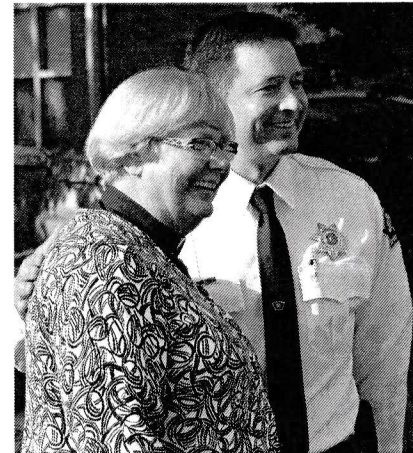

Several persons alleged that they have been pulled over while driving due to racial profiling, which Sheriff Schmaling repeatedly denied was department policy. People told of sheriff's deputies waiting outside Seven Mile Fair, Latino grocery stores,

and other locations popular among Latinos in order to pull Latinos over as they left. Undocumented aliens are not eligible for Wisconsin driver's licenses.

In answer to a complaint from a naturalized citizen who said that a deputy told her that he had pulled her over because he "felt like it," Sheriff Schmaling said, "Our deputy sheriffs, our police officers stop people for probable cause, based on violations of the traffic code. We don't stop people at random because we quote - unquote feel like it." He asked people who feel they have been unjustly stopped to report the incidents to him.

The forum was organized by the Racine Interfaith Coalition in cooperation with Voces de la Frontera, the Racine County Sheriff Department, Racine Police Department, and the office of Mayor John Dickert.

If it were not for the social justice commitment of the Latino ministry at Emaús, this forum would probably not have taken place, or it would been in a different place without such an impressive turn out. So please, let us make sure that the voice and efforts of our Latino ministry and of the leadership of Racine's Latino community are not silent or diminished.

Photo by Art Smith

Synod to Review Cluster Structure

Voting representatives at the 2013 Greater Milwaukee Synod Assembly May 30-June 1 approved six resolutions:

To create a task force to "review the status and future of synod clusters," to report to the 2014 Synod Assembly.

To create a task force to "develop a policy and procedure to handle the proceeds from the sale of property" of closed congregations, to report by the 2014 Synod Assembly.

To form a Refugee Resettlement Task Force to raise awareness of refugee needs; encourage congregations to consider co-sponsorship of arriving refugees; facilitate communication between service providers, volunteers and refugee communities; and be a voice for

those who often have no voice in our society.

To support the work of Peace Not Walls to bring about peace with justice for the people of Israel and Palestine, including urging the Churchwide Assembly to consider social investment screens and other actions to support investment in Palestine and to boycott products and services provided by companies that benefit from and support Israel's occupation of Palestine. Congregations are urged to observe the 24th day of each month as a worldwide day of prayer and solidarity with the Evangelical Lutheran Church in Jordan and the Holy Land.

To call upon the Churchwide Assembly to support legislation

→ Please turn to page 20

FaithWorks Is Making Progress

Art Smith reported at the June 23 congregational meeting on the progress being made by FaithWorks, the partnership of five Racine ELCA congregations. While some would like to see change and movement take place even more quickly, there is evidence of a steady movement forward.

Since the beginning of the year, each congregation has shared its mission through our Lenten Journey. In spite of bad weather on several of the Wednesday nights, a surprising number of people made it out enjoy the hospitality of each congregation.

Each congregation has formed a visioning team to develop a mission and vision statement, together with outcomes that they would like the FaithWorks congregations to embrace. The Emmaus visioning team meets on Mondays to develop our version of these concepts. At the July FaithWorks council meeting, each congregation will report out their ideas.

Going forward, you will hear a lot about the concept of Wholeness as it pertains to the mission of FaithWorks. In fact, an ELCA grant of over \$100,000 has been applied for, requesting support for a FaithWorks youth minister and a consultant to help us implement a wholeness program.

That consultant, Susan Gould, is already on board and is already helping us structure the process to get there.

The concept of wholeness includes physical, environmental, emotional, enrichment, spiritual, and place in the community. Since FaithWorks can't cover all the aspects of this concept, one of the tasks is to narrow the scope into a manageable piece that fits within our mission. This planning will start to happen this fall and will ramp up this coming winter when the grant money is anticipated. FaithWorks will learn the decision of those at the review table regarding the grant sometime in August.

In the meantime, you should look for the FaithWorks unit in the Fourth of July parade advertising the FaithWorks Fall Festival that will take place at St. Andrew's on 7-8 September. Please support the Festival and tell your neighbors about it! Each congregation will be encouraged to provide a number of baskets to be raffled at the Festival. Start now collecting goodies and gift cards that might be the contents of one or more of the baskets.

If you have any questions about FaithWorks please contact your Emmaus representatives, Art Smith, Melissa Lemke or Pastor Mary.

Emmaus Staff & Worship Times

Church: 1925 Summit Avenue, Racine, Wisconsin 53404-2374.

emmausracine@sbcglobal.net ☎ 262 634-5515

Pastors: Rev. Mary L. Janz 1530 S. Main St. 53403 mljanz@aol.com 633-3059

Rev. Jhon Freddy Correa jhoncorrea@hotmail.com 414-881-1403

Church office: Paul Berge emmausracine@sbcglobal.net

Education Coord.: Nancy Smith nnsdaisy@aol.com

Director Outreach: Liliana Moncada liliana.moncada@hotmail.com

President: Chris Lamberton Accompanist: Brenda Trumbauer

Custodians Antelmo Hernandez & Rich Benson

English language services are held at Emmaus every Saturday evening at 5:00, and Sunday mornings at 9:15. Spanish language worship services are offered Sundays at noon.

Emmaus office hours are 9:00 a.m. to 3:00 p.m. Monday through Friday (closed July 4).

The VISITOR is published monthly September to July. The deadline for the September VISITOR is August 15. Submit articles to Paul Berge's attention by mail or by e-mail.

Emmaus Visitor

Vol. 41, No. 11

July & August, 2013

Page 4

Emmaus Visitor ☉ Summer, 2013 ☉ Page 5

Congregations Get Ready for Neighborhood Camp

Lutheran Church of the Redeemer, Atonement, Emmaus and Our Savior's will host Racine ELCA Neighborhood Camps this summer. Each of the camps will run Monday through Thursday from July 1 to August 1 (except for July 4). Overall Neighborhood Camp Administrator Liliana Moncada and the site coordinators have been interviewing summer intern applicants, setting up schedules, and readying their respective buildings for the arrival of dozens of first through fifth graders.

For the second year, the sites will also offer "Serving and Learning Together" (SALT) for middle school youth simultaneously with the Neighborhood Camp program.

Emmaus has set up a link to download registration forms on the congregation's weblog. Photos will be posted on the congregation's Flickr site. Nancy Smith serves as the site coordinator.

Redeemer has set up a web site for their Neighborhood Camp. Visitors to the site can see what the theme and field trip of the week

will be, what sort of donations would be helpful, and download the camp registry forms. A contact page allows visitors to send messages to site coordinators Rebekah Hetchler and Rebekah Barbian; and once the camp begins, the staff will post photos on the site.

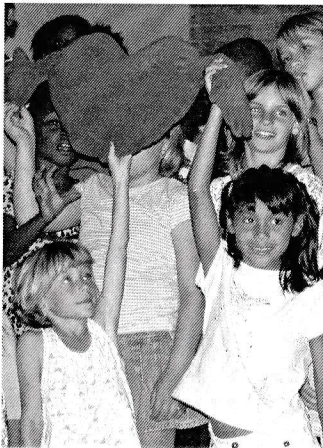

Atonement serves West Racine again this year. Site coordinator Diane Thygeson reports that while the SALT program has reached capacity, registration is still open for elementary age kids.

Volunteers will expand Our Savior's usual office hours to cover the time when camp is in session. Our Savior's continues valued service to its Uptown and near south side neighborhood. Camp is directed by Cathy Webster.

The free camp is made possible through grants from the Seibert Foundation, Outreach for Hope, the Department of Public Instruction, Racine Unified School District #1, Thrivent Financial for Lutherans, and gifts from individual donors and ELCA congregations.

Calling All Cooks and Bakers

While many have already volunteered to help as we feed Neighborhood Campers breakfast, lunch and a snack daily, there are still some opportunities to help out.

Consider making a batch of cookies or some fresh fruit for the campers. Help is also needed in

the kitchen during July. Dates of camp are July 1 to August 1, Monday through Thursday. If you can help one or more days, please contact Liliana Moncada (414 881-1491) or sign up in the church narthex.

A big thank you to all who have already said "yes!"

Summer Crew Builds Strange Octagon

Have you seen the octagon shape wooden structure near the alley in the field south of the church? If so, do you know what it is?

You win the prize if your answer is "a gaga ball pit." Thanks to the efforts of Art and Nancy Smith, Rich Christensen, Marco Carbajal, Tadrian Arthurs, Anthony Medina and Michael



Macias, the newly installed gaga ball pit is ready for this year's Neighborhood Campers.

Gaga is an Israeli version of dodge ball. Players stand inside the gaga pit, and someone throws a ball into the middle. With each bounce, the players yell "ga"

(Israeli for "hit"). Players bat the ball along the ground with their hands, bouncing it off the walls, trying to hit other players below the waist. A player cannot hit the ball twice in a row unless it

bounces off a wall or another person.

Once a player is hit, that player is out. A player who knocks the ball out of the pit is also out. If a player catches the ball in the air, the last person to have hit the ball is out. *Photos by Nancy Smith*

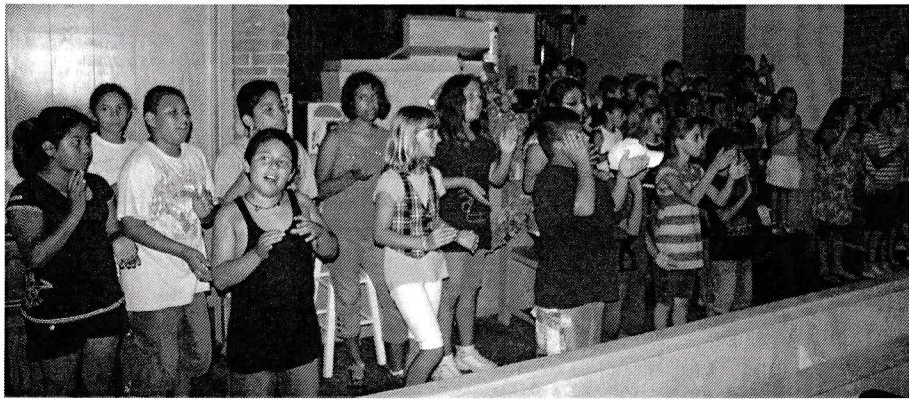

Campers to Present This Summer's Closing Program August 1

Thursday, August 1 is the final day of Neighborhood Camp for the summer. Campers, families, friends and members of Emmaus are invited to a closing picnic at 6:00 p.m. that day. Hot dogs, water, soda and ice cream will be provided. Salads and desserts are welcomed by those attending.

At 7:00 p.m., there will be a closing program in the sanctuary of the church. Reading rewards and other recognitions will be given.

The campers will share an original presentation with those attending the final program.

Photo by Art Smith

Youth Birthdays

July 9	Veronica Maldonado, 9	Aug. 11	Samuel Martinez, 4
July 11	Kevin Garcia, 11	Aug. 21	Cole Cacciotti, 6
July 12	Mason Jamieson, 3	Aug. 21	Giselle Becerra, 12
July 14	Anthony Medina, 17	Aug. 21	Saul Sánchez, 16
July 16	Glenndon Toslek, 5	Aug. 23	Marleni Aragon, 5
July 17	Jaydan Ponder, 5	Aug. 24	Elliot Bonn, 1
July 22	Giselle Gallegos, 14	Aug. 25	Abel Velasquez, 12
July 23	Adriana Zavala, 7	Aug. 26	Alexa Ahrens, 14
July 25	Jennifer Lopez, 14	Aug. 28	Diana Rubio, 9
July 26	Alexis Austin, 17	Aug. 29	Irma Gallardo, 15
July 30	Melissa Rubio, 16	Aug. 29	Mark Nunez, 13
July 31	Alejandra Antonio, 4	Aug. 31	Alexander Lopez, 3
Aug. 6	Mercedes Cruz, 10		

Help Stock Food Pantry Shelves

As we strive to fill empty food pantry shelves, the Northside Food Pantry needs your help to supply the following (plus brown paper bags):

chunk-style soup
canned spaghetti with meat
toilet paper; disposable
diapers; women's
sanitary items
canned ravioli, bar soap
baked beans, hamburger
helper

If you would prefer, monetary donations are always welcomed to purchase those items that we often run short of and/or are not available for a particular month. Checks can be made out to Emmaus with a notation on your offering envelope designating that the offering is for the Northside Food Pantry.



We are always in need of volunteers to work at the Pantry. Work hours are from 1:00 p.m. to approximately 4:00 p.m. on Tuesdays and Thursdays of each month. If you would like to see your Pantry in operation or have any questions, please contact Cindi Larsen at 681-2082. Each of our supporting eight churches also has dedicated volunteers who volunteer to serve in this important ministry. They are a valuable source of information if you have any questions.

Thank you again for your continued support through your time, donations, and prayers as we all work to support and maintain this important ministry within our community.

Summer Birthdays: 70 Years and Better

July 9	Helen Mickelson	1737 Shoop Street	53404
July 18	Joy Lamberton	1027 Berkeley Drive	53402
July 21	Eleanor Lawrenz	1921 Mt. Pleasant Street	53404
July 25	Nancy Smith	1530 S. Main Street	53403
July 31	Edna Mathieus	1716 Warwick Way	53406
August 2	Larry Nielsen	1206 Fairway Drive	53405
August 6	Shirley Irvine	5119 Valley Trail	53402
August 12	Joyce Kaiser	14220 56th Road, Sturtevant	53177
August 15	Rich Christensen	1019 Hwy. V, Sturtevant	53177
August 21	Jerry Doughty	1921 Arcturus Avenue	53404
August 22	Doris Andersen	3125 Candle Court #7	53402
August 25	Ron Jensen	5512 W. Branch Trail	53402
August 27	Richard Larsen	4202 Erie Street	53402

Summer Worship Assistants

	Altar Guild	Communion Assistants	Readers	Ushers
Sat. Jul. 6 5:00 pm	Marge & Amy Zielke Missy Porcaro	—	—	—
Sun. Jul. 7 9:15 am	Bev Hansen Audrey Villalobos	Shirley Velzka	Nancy Smith	Team 4 Meteyard
Sat. Jul. 13 1:00 pm	Judy Berndt Linda Meteyard	—	—	—
Sun. Jul. 14 9:15 am	Kathy Christensen Marlyn Christensen	Carol Eschmann Cindi Larsen	Karen Sedgwick	Team 2 Christensen
Sat. Jul. 20 5:00 pm	Cathy Meyer Linda Clinton	—	—	—
Sun. Jul. 21 9:15 am	Barb Larsen Pat Jensen	Nancy Smith	Sandy Strini	Team 1
Sat. Jul. 27 5:00 pm	Brian & Denise Keller	—	—	—
Sun. Jul. 28 9:15 am	Caren Lamberton	Kathy Christensen Chris Lamberton	Carol Eschmann	Team 3
Sat. Aug. 3 5:00 pm	Barb Toslek Jamie Toslek	—	—	—
Sun. Aug. 4 9:15 am	Joy Lippmann Marge Jensen	Pat Jensen	Jim Larrabee	Team 4 Meteyard
Sat. Aug. 10 5:00 pm	Cheryl Dexter	—	—	—
Sun. Aug. 11 9:15 am	Kathy Christensen Marlyn Christensen	Joy Lippmann Karen Sedgwick	Chris Lamberton	Team 5 Porcaro
Sat. Aug. 17 5:00 pm	Marge & Amy Zielke Missy Porcaro	—	—	—
Sun. Aug. 18 10:00 am	Grace Falaschi	Diane Melander	Kathy Christensen	Team 1
Sat. Aug. 24 5:00 pm	Judy Berndt Linda Meteyard	—	—	—
Sun. Aug. 25 9:15 am	Caren Lamberton	Chris Lamberton Shirley Velzka	John Knuteson	Team 2 Christensen
Sat. Aug. 31 5:00 pm	Brian & Denise Keller	—	—	—
Sun. Sep. 1 9:15 am	Bev Hansen Audrey Villalobos	Cindi Larsen	Amy Haman	Team 3

Coffee & Fellowship Hosts:

Please sign up on the sheet on the Sunset Room door.
Emmaus Visitor ☼ Summer, 2013 ☼ Page 10

WEDNESDAY	THURSDAY	FRIDAY	SATURDAY
ST. THOMAS 10 am Neighborhood Camp 1:00 am Weekend bulletin deadline	4 INDEPENDENCE DAY <i>Office closed; no Neighborhood Camp or GED.</i> 9:00 am FaithWorks in July Fourth parade	5 6:00 pm Support group	6 1:00 pm Oviedo quinceañera 5:00 pm Worship service with Holy Communion (English)
<i>Pastor Mary's week off</i>			
0 10 am Neighborhood Camp 1:00 pm Dr. Hows at 1530 Main St., to 8:00	11 9:00 am Neighborhood Camp 11:00 am Sun. bulletin deadline 4:00 pm BENNU legal appointments 6:00 pm GED math class 7:00 pm FaithWorks Mission Council	12 6:00 pm Support group	13 1:00 pm Albiter baptism 5:00 pm Worship service with Holy Communion (English)
7 10 am Neighborhood Camp	18 9:00 am Neighborhood Camp 11:00 am Sun. bulletin deadline 6:00 pm GED math class	19 6:00 pm Support group	20 DAY OF PRAYER FOR PEACE IN MIDDLE EAST 5:00 pm Worship service with Holy Communion (English)
<i>Pastor Mary away</i>			
4 10 am Neighborhood Camp	25 JAMES THE ELDER 9:00 am Neighborhood Camp 11:00 am Sun. bulletin deadline 4:00 pm BENNU legal appointments 6:00 pm GED math class	26 6:00 pm Support group	27 2:00 pm Beas quinceañera 5:00 pm Worship service with Holy Communion (English)
<i>Retiro juvenil en Green Lake</i>			
1 10 am Neighborhood Camp	<p style="text-align: center;">Emmaus Evangelical Lutheran Church</p> 1925 Summit Avenue, Racine, Wis. Phone 262 634 5515 Email emmausracine@sbcglobal.net http://emmausracine.wordpress.com		



SUNDAY

MONDAY

TUESDAY

WEDNESDAY

THURSDAY

FRIDAY

SATURDAY



Emmaus Evangelical Lutheran Church

1925 Summit Avenue, Racine, Wisconsin 53404-2374
 Phone 262 634-5515 email emmausracine@sbcglobal.net
 http://emmausracine.wordpress.com
 www.facebook.com/pages/Emmaus-Racine/227181193993978

August 1

11:00 am Bulletin
 deadline
 6:00 pm Supper
 7:00 pm Neighborhood
 Camp closing program
 7:00 pm FaithWorks
 Mission Council

2

6:00 pm
 Support
 group

3

10:30 am Soria baptism
 12:00 d Hernández-Cadena
 anniversary
5:00 pm Worship service
 w/HC (English)

4 9TH SUNDAY AFTER PENTECOST

9:15 am Worship service (English) with
 Holy Communion
 10:30 am Coffee & fellowship
12:00 noon Santa Misa (español)
 12:30 pm Kids' Camp

5

6

5:00 pm TOPS

7

8

11:00 am Sun. bulletin
 deadline
 4:00 pm BENNU legal
 appointments
 4:00 pm LL Auxiliary Ice
 Cream Social, at Lincoln
 Villas

9

6:00 pm
 Support
 group

10

12:00 día Hernando
 presentación
5:00 pm Worship service
 with Holy Communion
 (English)

Pastor Mary's week off

11 10TH SUNDAY AFTER PENTECOST

9:15 am Worship service (English) with
 Holy Communion
 10:30 am Coffee & fellowship
12:00 noon Santa Misa (español)
 12:30 pm Kids' Camp

12

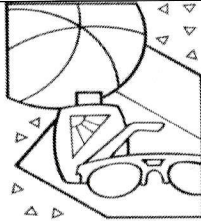

13

5:00 pm TOPS

14 V-J DAY

15 MARY, MOTHER OF OUR

LORD
 11:00 am Sun. bulletin
 deadline
 Sept. *Visitor* articles
 needed

16

6:00 pm
 Support
 group

17

12:00 día First communion
 service (español)
5:00 pm Worship service
 with Holy Communion
 (English)

Pastor Mary on vacation

18 11TH SUNDAY AFTER PENTECOST

9:15 am Chicago Folk service with Holy
 Communion (English)
 10:30 am Coffee & fellowship
12:00 noon Santa Misa (español)
 12:30 pm Kids' Camp

19

20 DAY OF PRAYER FOR

PEACE IN THE MIDDLE
 EAST
 5:00 pm TOPS

21

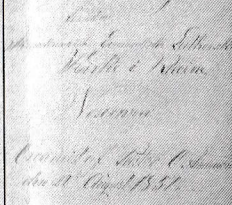

22 EMMAUS FOUNDED,

1851
 11:00 am Sun. bulletin
 deadline
 4:00 pm BENNU legal
 appointments

23 St.

BARTHOLOMEW
 6:00 pm
 Support
 group

24

2:30 pm Zavaleta
 presentación
5:00 pm Worship service
 with Holy Communion
 (English)

25 12TH SUNDAY AFTER PENTECOST

9:15 am Worship service (English) with
 Holy Communion
 10:30 am Coffee & fellowship
12:00 noon Santa Misa (español)
 12:30 pm Kids' Camp
 2:00 pm Gallardo quinceañera

26

27

5:00 pm TOPS

28

29 MARTYRDOM OF JOHN

THE BAPTIST
 11:00 am Sun.
 bulletin
 deadline



30

6:00 pm
 Support
 group

31

5:00 pm Worship service
 with Holy Communion
 (English)

SUNDAY	MONDAY	TUESDAY	3
	July 1 CANADA DAY 9:00 am Neighborhood Camp	2 9:00 am Neighborhood Camp 5:00 pm TOPS 6:00 pm GED class	9: 11
7TH SUNDAY AFTER PENTECOST 9:15 am Worship service w/Holy Communion (English) 10:30 am Coffee & fellowship 12:00 noon Santa Misa (español) 12:30 pm Kids' Camp	8 9:00 am Neighborhood Camp 11:30 am Worship & Music committee	9 9:00 am Neighborhood Camp 5:00 pm TOPS 6:00 pm GED class	10 9: 6:
14TH 8 TH SUNDAY AFTER PENTECOST; BASTILLE DAY 9:15 am Worship Service (English) with Holy Communion 10:30 am Coffee & fellowship 12:00 noon Santa misa (español) 12:30 pm Kids' Camp	15 9:00 am Neighborhood Camp	16 9:00 am Neighborhood Camp 5:00 pm TOPS 6:00 pm GED class 6:30 pm Church council mtg.	17 9: 9:
21ST 9 TH SUNDAY AFTER PENTECOST 8:00 am Musicians' rehearsal 9:15 am Chicago Folk service (English) with Holy Communion 10:30 am Coffee & fellowship 12:00 noon Santa Misa (español) 12:30 pm Kids' Camp	22 MARY MAGDALENE 9:00 am Neighborhood Camp  <i>Saint Mary Magdalene</i>	23 9:00 am Neighborhood Camp 5:00 pm TOPS 6:00 pm GED class	24 9:
<i>Pastor Mary away</i>			
28TH 8 TH SUNDAY AFTER PENTECOST 9:15 am Worship service (English) with Holy Communion 10:30 am Coffee & fellowship 12:00 noon Santa Misa (español) 12:30 pm Kids' Camp	29 9:00 am Neighborhood Camp	30 9:00 am Neighborhood Camp 5:00 pm TOPS 6:00 pm GED class	31 9:
<i>Retiro juvenil en Green Lake</i>			

Gethsemane Celebrates Centennial

The youngest of our daughter congregations, Gethsemane Evangelical Lutheran Church, 3319 Washington Avenue, celebrates its centennial this summer.

Between the time since Emmaus was built in 1878 on what is now Mound Avenue and the 1910's, many of the older members had moved from that neighborhood to the West Racine area.

Several of them wanted the church to move to the site on West Boulevard where the CVS Pharmacy now stands; records suggest that Emmaus's pastor at the time, Rev. Søren Eriksen, agreed.

Others retained an emotional attachment to the old church building. At a congregational meeting to decide the question on August 22, 1910, there were 32 votes in favor of moving, 24 votes against, and 14 ballots left blank. The church constitution required majority approval of the question, so the blank votes might as well have been "nay" votes.

In June, 1912, a petition "signed by 18 members and 9 young men" (as P.S. Vig's history of Emmaus puts it) brought the matter before the congregation

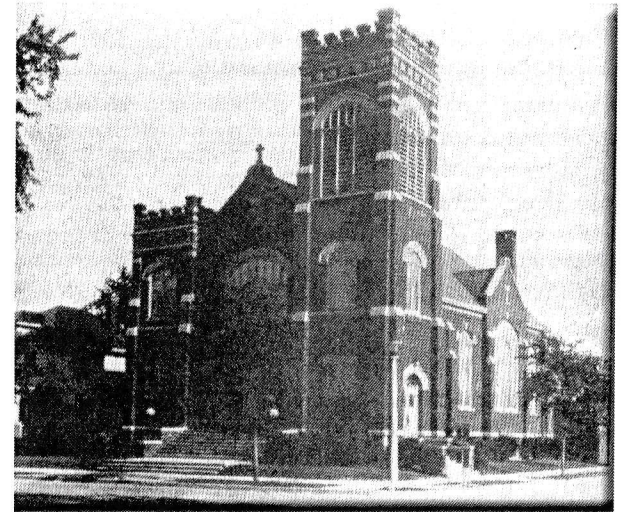

again, but the re-vote again failed to settle the issue.

Rev. Eriksen returned home to Denmark in 1913, and in the interim between his resignation and the return of Rev. Christian Jensen for his second pastorate here, 38 members left Emmaus to found Gethsemane.

Gethsemane will celebrate its 100th anniversary with an open house from 11:00 to 2:00 on Saturday, July 13 and a worship celebration at 10:10 a.m. Sunday, July 14. Everyone is invited to help celebrate.

Memorials & Honoraria

Non-designated:

In honor of Ken & April Larsen on their wedding: \$100.00

From the Mailbox

Christensens Open House for Anniversary Celebration

Come Celebrate With Us.

We invite our Emmaus Family to come to an Open House celebration of our 50th wedding anniversary.

Date: Saturday, August 17

Time: 2:00 - 6:00

Place: 1019 Highway V
(corner of V & 20)

No gifts please (we really mean it)

—Rich and Kathy Christensen

Summer Bible Readings

July 7: Isaiah 66:10-14; Psalm 66:1-9; Galatians 6:[1-6] 7-16; Luke 10:1-11, 16-20.

July 14: Deuteronomy 30:9-14; Psalm 25:1-10; Colossians 1:1-14; Luke 10:25-37.

July 21: Genesis 18:1-10a; Psalm 15; Colossians 1:15-28; Luke 10:38-42.

July 28: Genesis 18:20-32; Psalm 138; Colossians 2:6-15 [16-19]; Luke 11:1-13.

Aug. 4: Ecclesiastes 1:2, 12-14; 2:18-23; Psalm 49:1-12; Colossians 3:1-11; Luke 12:13-21

Aug. 11: Genesis 15:1-6; Psalm 33:12-22; Hebrews 11:1-3, 8-16; Luke 12:32-40

Aug. 18: Jeremiah 23:23-29; Psalm 82; Hebrews 11:29-12:2; Luke 12:49-56.

Aug. 25: Isaiah 58:9b-14; Psalm 103:1-8; Hebrews 12:18-29; Luke 13:10-17.

Sept. 1: Proverbs 25:6-7; Psalm 112; Hebrews 13:1-8, 15-16; Luke 14:1, 7-14.



Lutherdale Fest Has Something for Everyone

Lutherdale Bible Camp holds its annual Fest and Quilt Auction Saturday, August 10 from 8:00 a.m. to 4:00 p.m. The quilt preview and fish fry runs from 4:00 to 8:00 p.m. on August 9; meal tickets are \$12 for adults, \$7 for youth.

The live auction with quilts and quilted items begins at 10:00 a.m. and continues until all items are sold. Fresh baked goods, fall

mums, and garden produce will be for sale. Pontoon rides on the lake are available all day.

A fun-filled schedule for the kids includes climbing tower, swimming, arts and crafts, s'mores and more. The cost is \$25 per child.

Lutherdale is a non-profit organization located at N7891 US Hwy. 12, Elkhorn; phone 262-742-2352, or visit www.lutherdale.org.

Community Meal Director: 'Cool It!'

Because of last year's hot summer, St. Patrick's has decided not to use its ovens to cook food for Community Meals this summer. Emmaus and other contributing congregations are asked not to bring the usual casseroles.



Instead, please substitute food that can be heated in a Nesco or served cold. Community Meal Director Margaret Clickner suggests hot dogs, beans, chips, tacos, hamburgers, brats, sloppy joes, sub sandwiches, cold pasta salads, leaf salad, pickles, olives, and fresh fruit.

"These are some examples, but if you can come up with some personal favorites that you make during hot days, they would be greatly appreciated," Clickner said. "We know how we feel in the heat; this solution will also help those who make the dishes. You won't have to heat up your kitchen, either!

"Ovens will not be used from June 1 until September 26. Also, please use a spray in pans; this will help our dish washers a lot."

The next meal that we will serve at St. Pat's is on Thursday, August 1. Watch for the new sign-up sheet and the pans to reappear in the narthex in early July.

Food Pantry Volunteer Schedule

July 25: Cindi Larsen, Marge Zielke, Boots LeRoux, Art Smith
August 22: Kathy & Rich Christensen, Cheryl Dexter, Ron & Pat Jensen
September 26: June Beck, James Larrabee, Boots LeRoux, Art Smith

RIC Participates in Gun Buyback

Racine Interfaith Coalition, NAACP, Community For Change and the Racine Police Department are working together to make the city streets safer for the community by sponsoring a Gun Buyback on Saturday, July 27 from 10:00 a.m. to 6:00 p.m. at the Urban League, located at 718 N. Memorial Dr., Racine.

After every homicide for 15 years, RIC has had vigils to give witness for peace and non-violence. Sponsorship money is needed so RIC, NAACP and Community For Change can exchange guns for cash. Please send check to RIC at 2302A DeKoven Ave., Racine, WI 53403. Phone 262-635-9532

Pastor Jhon Freddy Shares a Word of Thanks

At the congregational meeting held Sunday, June 23, Pastor Jhon Freddy shared a word of thanks on behalf of the Latino community known as Emaús. Following is an expanded written version, which reflects his message to the Emmaus congregation:

What does 6 really mean at Emmaus? IN JUNE=6 2013=6 LATIN@=6 THANKS=6 EMMAUS=6

The first thing that may come to mind for some when they see lots of number sixes together is evil. Perhaps you are one of them. Today I want to challenge your mind to hear what your heart is really thinking about!

Reading numerology, I found that the number 6 is the "Mother" number, and is essentially a working, building number. It symbolizes responsibility and service, which needs to be achieved through love, nurturing and protection. This sounds to me like what E+m+m+a+u+s=6 is and does!

During this time of fear, anger, mistrust, corruption, and selfishness that can lead to a mentality of scarcity, I agree that a number of sixes together could be interpreted to represent evil. But today, in the middle of all the frustration that may surround us, Emmaus has changed that

mindset, focusing not on evil, but rather on THANKSfulness.

In the sixth month of the year 2013, I want to take a moment to acknowledge and thank you for your commitment, passion and compassion for all the children of God in the fight for justice against evil. There is an innate desire within the number 6 to bring harmony, peace, justice and truth to all experiences in life according to those who study numerology. We have changed our mindset and have chosen to see so many possibilities,

blessings, hopes around us even when so many others can only see fear and evil.

Emmaus, I want to share with you that the Latino ministry would not have blessed and touched so many lives without your help. The number 6 symbolizes what you have been for the Latino ministry: the principle of nurturing, caring and harmony. Yes! you have been a great partner, touching many lives, empowering widows, orphans, unemployed, single moms/dads, and especially those children growing up in our society with broken systems, such as

➔ Please turn to page 19

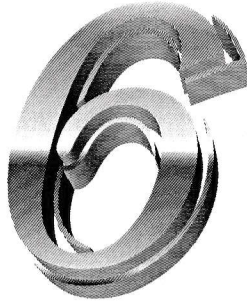

Green Team Invites Green Thumbs

By Sandy Strini

Anyone who likes to get a little exercise outdoors is welcome to join the Green Team Weeders on Wednesday morning. You may come any time from 10:00 a.m. to noon and pull as many weeds or trim as many bushes as you would

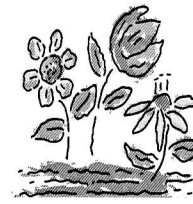

like. The group is totally flexible. We are enjoying the beautiful weather, the social interaction and all the horticultural therapy

that this activity provides.

Pastor Jhon Freddy's Column

➔ Continued from page 18

immigration reform, schools, safety in neighborhoods, and economic loss. Unfortunately, many families have lost their houses in the last two years. What this means is that they have lost years of savings and investments, using all the savings that once was set aside for the education of their kids. Today thanks to our economy, it is all gone. According to numerology, the personal goal of the number 6's personality is to provide for others' wellbeing – to create security and harmony – to love. Thanks to you, Emmaus=6, we have been there to walk, as the disciples in Luke chapter 24=6, walked back to that little town. We have been that partner with them on their desolate road. We have sat with them, we have broken bread together, we have seen how God works, we have seen the glory of our God through your commitment, your love and support!

Number 6 represents truth, order, justice and economy. Number 6 people will have many opportunities in their life to learn their responsibilities, and to give service to humanity. Emmaus=6 and THANKS=6 both words of only six letters, capturing that same excitement as in the sixth day of creation, the day when all was done/created and God declared it was good. It is that same delight that we experience in this partnership by seeing all that has been done together. During this sixth month of 2013, Emmaus was featured two days in a row on the first page of the Racine *Journal Times*. Emmaus is creating change in our community through education (G.E.D, ESL, Coach, Leadership, and lots more). Thanks again! And remember: number 6=EMMAUS – there is still a lot more energy within us to continue in this very important mission of God in this place!

Emmaus Visitor ☼ Summer, 2013 ☼ Page 19

Synod Assembly

→ Continued from page 4

prohibiting employment discrimination on the basis of actual or perceived sexual orientation or gender identity, while urging church leaders, both clergy and lay, to speak in favor of such legislation.

To direct the synod to edit its compensation guidelines to reflect the ELCA health plan option that most closely resembles current ELCA primary health coverage for rostered leaders.

Scott Manske (Martin Luther LC, Milwaukee) was elected Greater Milwaukee Synod Council Vice President. Lee Johnston (Redeemer LC, Milwaukee) was elected Treasurer.

Budget

The Assembly approved the synod's budget for the fiscal year ending January 31, 2015, with total income of \$2,196,500 and total expenses of \$2,221,080.

Reports and Discussion

Former ELCA Presiding Bishop Herb Chilstrom provided an overview of the formation of the ELCA, emphasizing that this church was "bold and forthright in standing up for human rights and the liberty of all people," and that "even though it is costly to take stands" on many issues, he is "proud to be part of [this] church."

Emmanuel Visitor ☼ Summer, 2013 ☼ Page 20

Mr. Samson Kiware, a Carthage College alum and doctoral candidate at Marquette University, told the assembly



about work he is doing through mathematical research to combat malaria in Tanzania, his home country.

In his report, Bishop Jeff Barrow called for a vibrant synod as part of a vibrant church, saying that "the church is changing," something we must acknowledge with a nod to the passing generation, but without looking at what we leave behind. "We have to drop all this stuff that isn't important." The young, he said, are "looking at the story of the living God, not just a collection of harsh rules," continuing that he hopes "we can become increasingly passionate about gathering around scripture." The bishop also addressed issues of hunger, of advocacy and of the ongoing need for healthy churches and healthy leaders.

Photo by Tracy Apps

Elsewhere in Our Area

Lakota Author to Discuss His Book

The Synod Anti-Racism Team invites you to a book discussion of *One Church, Many Tribes: Following Jesus the Way God Made You* by Richard Twiss, 7:00 p.m., Thursday, August 8 at the Synod Conference Room, Greater Milwaukee Synod Office, 1212 S. Layton Blvd., Milwaukee. (Use rear parking lot of Ascension Lutheran and synod office rear entrance going down steps and turning left to conference room)

Since Columbus landed in the West Indies in 1492, Native American tribes have endured more than five centuries of abuse, hypocrisy, indifference and bloodshed at the hands of the "Christian" white man. Despite this painful history, a number of Native Americans have found "The Jesus Way" and are proving to be a powerful voice for the Lord around the world. A full-blooded Lakota/Sioux whose bitterness toward whites was washed away by the blood of Christ, Richard Twiss shows that Native American Christians have much to offer the Church and can become a major force for reaching the lost. Full of wisdom, humor and passion, this book examines how the white Church can begin to break down the walls of anger, distrust and

bitterness and move toward reconciliation and revival in our land.

Available in both paperback and electronic editions or your public library

Asante Children's Choir Sings at Emmanuel

Emmanuel Lutheran will host the Asante Children's Choir from East Africa on August 23. Many of these children have survived very

difficult situations, and now come together to spread a message of love, hope, and joy while sharing their stories.

Emmanuel needs your help to make this

an incredible event. If you have a spare bedroom or two, can provide breakfast and pack a lunch, please consider hosting a chaperone and two to three children. A total of 12 - 15 homes are needed for the group. If you have a love for the children of the world and would like to help prepare for their August 23 visit, please contact Pastor Jane Fryda (cell phone: 262-945-3702).



children's choir

Emmanuel Visitor ☼ Summer, 2013 ☼ Page 21

Auxiliary Hosts Ice Cream Social August 8

The Lincoln Lutheran Auxiliary will host its annual Ice Cream Social on Thursday, August 8 from 4:00-7:00 p.m. at Lincoln Villas Apartments, 5820 Lincoln Village Drive (behind Mt. Pleasant Lutheran Church.) Each of the churches will be asked to provide pies and workers for this annual fund raiser.



All proceeds will be used to fund the Auxiliary's projects which benefit the residents and program participants of Lincoln Lutheran with matching funds provided by Thrivent Financial.

Plan to join them for good food and fellowship!

It's their 40th annual ice cream social, for those keeping count.

RUSD Plans Fest

The tenth annual Back to School/Stay in School Fest is a citywide event scheduled to be held on Monday, August 19 at the Racine on the Lake Festival Hall.

Please mark your calendar for this special event. A \$4.00 donation will allow you to enjoy delicious pie or cake, ice cream, and a choice of beverage. Brats, hot dogs and chips will be sold separately.

Crunching the Numbers

Weekly worship attendance averages (calculated as of June 24, 2013)

	2011				2012			2013		
	Sat	Sun	Dom	Wed	Sat	Sun	Dom	Sat	Sun	Dom
My	20	69	185	83	10	53	142	15	62	130
Je	16	50	171	—	13	48	143	16	49	110
Jl	14	46	128	—	15	53	127			
Au	21	49	119	—	9	39	158			

Financial Figures

General Fund offerings received in May 2013	\$21,280.92 }	Total for month	2013 to date
+ Special envelopes/gifts:	\$100.00 }		\$65,300.19

Mortgage retirement offerings received in May '13	\$130.00	Campaign TD:	\$72,762.62
Mortgage payments in May, 2013:		Principal balance as of	
Principal	\$845.55	June 14, 2013:	
Interest	\$146.45		
Total	\$992.00		\$27,113.92

Memories, Nostalgia and Reality

Later in July, I will be boarding a plane in an attempt to step back in time. That plane will take me to Minot, North Dakota, where I graduated from high school 50 years ago. I have so many memories — of the elementary, junior high and high schools, and of the home where I grew up.

But it won't be the same. Three of those four buildings were so severely damaged by the flood three years ago that they can no longer even be used. Only the high school escaped that devastation.



And the influx of people due to the oil boom in my home state means that housing and rooms are at a premium. The population has been growing faster than the infrastructure. Unemployment is the lowest in the country. I'm sure that there will be things I will not even recognize since my last trip to Minot just over three years ago!

And you know what? I bet I won't recognize all those "old" people who will be attending my class reunion! Somehow, most of us don't look like those pictures that appeared in the yearbook! Class ranks, "Most likely to

succeed" titles, and letters pinned on a letter jacket will not be the focus of our time together. And, while there will be memories shared, what I'm looking forward to most is hearing the stories of what has happened since 1963 in the lives of my former classmates.

I have a feeling that what I will come back with will be a sense of gratitude, not only for my roots, but also for the opportunities to grow and to change in the past 50 years of my life. I am already grateful that community can take place wherever one is planted, and that community has fed and nurtured me in Minot,

Moorhead, Mexico, Madrid, Minneapolis—and now in Racine.

I am grateful that God gives us the ability to be resilient and to adapt and to move into the future, no matter where that may take us.

I am very sure that when the plane arrives in Milwaukee on July 21, I will be very happy to be "home" again. And yet, I look forward in anticipation, wondering and imagining where God may lead us in the next chapter of our lives together!

Ready for new adventures,

Pastor Mary
Pastor Mary

In the Summer Visitor:

- ⚙ Synod Assembly
Approves Six Resolutions
- ⚙ FaithWorks Progress
- ⚙ Going Gaga for
Neighborhood Camp
- ⚙ Gethsemane Celebrates
Centennial
- ⚙ Christensens Celebrate
Golden Anniversary
- ⚙ Think Cool for Community
Meal
- ⚙ What Does 6 Mean?
- ⚙ Green Thumbs Wanted
- ⚙ Auxiliary Ice Cream Social
- ⚙ Nostalgia and Reality
... and plenty more

Emmaus Evangelical Lutheran Church
1925 Summit Avenue
Racine, Wisconsin 53404-2374

Change service requested

Non-Profit Org.
U.S. Postage PAID
Racine, WI
Permit No. 137

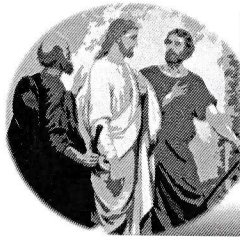

Emmaus Visitor

September, 2013

Congregational Meeting Set to Address Collaboration, Possible Change of Worship Times

As a result of conversation among our FaithWorks partners, possibilities are now being studied regarding closer collaboration between Emmaus and St. Andrew, the two north side FaithWorks congregations. There are a number of "what if..." questions that will be introduced at a Question and Answer session during the September 15 coffee hour. It is anticipated that some of those questions might include:

What if St. Andrew and Emmaus were willing to change their worship times to allow for the same preacher and musician to cover both congregations on a Sunday morning? (Example: one group would worship at 8:30 a.m. and the other at 10:15 a.m.)

What if the Saturday worship were combined for the two congregations, rotating the location of the service every three months? (Example: worship would be at 4:30 p.m. at one location for October, November, and December and then move to the other location for three months.)

What if Brenda would be the musician at both locations? (The St. Andrew musician has recently resigned, and this would allow us to share a musician. Joyce Kaiser would continue to play the organ at Emmaus the last Sunday of each month.)

↳ Please turn to page 2



Emmaus Evangelical Lutheran Church
"Sent Forth by God's Blessing"
e-mail: emmausracine@sbcglobal.net
<http://emmausracine.wordpress.com>

1925 Summit Avenue
Racine, Wisconsin 53404
Phone: 262 634-5515
Fax 262 634-0835

Pastoral Acts

Baptisms: Manuel JR Martinez June 22, 2013	Manuel is the son of Nina Davis and Manuel Martinez JR. His sponsor is Danny.
Angel Eduardo Albiter Huibina July 13, 2013	Angel is the son of Karen Karina Hubina Cates and Eduardo Albiter Torrijos; his sponsors are Ravel Albiter and Blanca Tavar.
Funeral: Harris P. Larsen July 15, 2013	Harris Larsen, father of Loren (Cindi) Larsen, passed away in Milwaukee on July 11 at the age of 94. Mr. Larsen was a veteran of the 28 th Division Army of Combat Engineers in World War II. Pastor Mary presided over the funeral at his church home, Ascension Lutheran, Milwaukee.

Remember Lanning Family in Your Prayers

Former Emmaus Adult Choir director Norm Lanning passed away in August. His funeral will be at Draeger Langendorf Funeral

Home at 3:00 p.m. Sunday, September 1, with visitation from noon to 3:00. Mr. Lanning directed the choir from 1981 to 1992.

Congregational Meeting

↪ Continued from page 1

These questions and others will then be dealt with at a special congregational meeting scheduled for September 22 at 10:45 a.m. in the Sunset Room. St. Andrew will have a congregational meeting that same morning, and these will be among the items expected to be discussed. (See also article on page 14.)

Please make every effort to be a part of this important discussion! If you have other items you feel

should be addressed at the congregational meeting, please contact council president Chris Lamberton or Pastor Mary.

Lydia Circle to Resume September 11

Women's Bible study meets in the Sunset Room at 1:30 p.m. on the second Wednesday of the month, beginning September 11.

Congregations Reunite for FaithWorks Fall Festival

Mark your calendar for the FaithWorks Fall Festival to be held at St. Andrew Lutheran Church, 1015 Four Mile Road, on September 7 and 8. Come for food, fun and entertainment for all ages!

The festival is sponsored by the FaithWorks ELCA congregations of Racine: Emmaus/Emaús, Atonement East and West, Redeemer, Our Savior's and St. Andrew.

There will be no Sunday worship at Emmaus on September 8. We will join our FaithWorks partners for worship at St. Andrew at 10:00 a.m. that Sunday in a joint worship service.

There will be Saturday worship at Emmaus on September 7 at 5:00 p.m., however.

This will be a big event. Everyone from each congregation will have an opportunity to contribute. A planning team, representing the five congregations, has been coordinating all the details. But they still need your help.

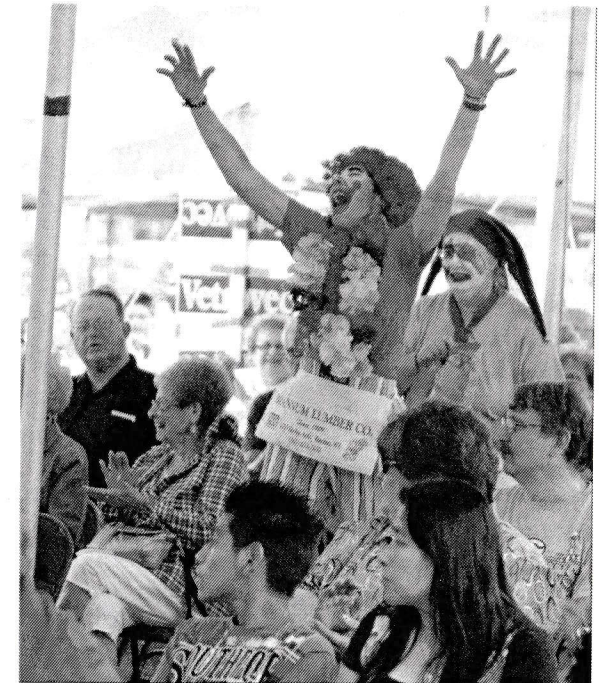

You can sell raffle tickets, solicit sponsors, bake items for the bake sale, help with games, direct traffic, or help with set-up or clean-up. Perhaps you know a band or musician that would be eager to play on one of our two stages.

Bouncy houses, face painting, balloon art and games will be offered for the kids. Bingo games will be offered for the adults. Various musical groups will perform on two stages both days of the festival. Cash prizes ranging

↪ Please turn to page 17

Come, Celebrate Season of Creation

An expression of collaboration of FaithWorks congregations Emmaus and St. Andrew will be evident during four weeks of worship during the Season of Creation. Beginning the weekend of September 14 and 15, there will be a rotation of four pastors, preaching and leading worship at the two churches.

The Emmaus worship schedule for the four weeks, each with a different theme, will be:

September 14 and 15 - Dr. David Rhoads preaching (Theme: Animals) with Pastor Mary presiding. Job 39:1-12, 26-30, Psalm 104:14-23, 31, 1 Corinthians 1:10-23, Luke 12:22-31.

September 21 and 22 - Pastor Mary preaching and presiding

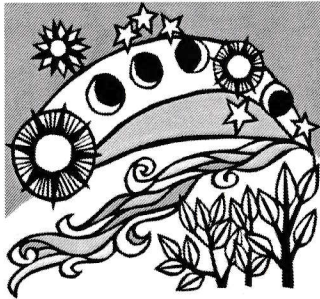

(Theme: Universe) Proverbs 8:22-31, Psalm 104:24-26, Colossians 1:15-20, John 6:41-51.

September 28 and 29 - Pastor Marcy Wieties preaching and presiding (Theme: Ocean) Job 38:1-18, Psalm 104:24-26, Ephesians 1:3-10, Luke 5:1-11.

October 5 and 6 - Pastor Michael Mueller preaching and presiding (Theme: Storm) Job 28:20-27, Psalm 29, 1 Corinthians 1:21-31, Luke 8:22-25.

St. Andrew worship times are Saturday at 4:30 and Sunday at 9:00 a.m. The preaching schedule for St. Andrew is as follows:

Sept. 14 and 15 - Pastor Michael Mueller

Sept. 21 and 22 - Dr. David Rhoads

Sept. 28 and 29 - Pastor Mary Janz

October 5 and 6 - Pastor Marcy Wieties

School Supplies Needed

Last call for school supplies! Emmaus has partnered with Wadewitz, our neighborhood elementary school, for 13 years. Please help by providing the students with pencils, paper, notebooks, crayons, markers, rulers, high-lighters, glue and erasers. Even backpacks, hand sanitizer and Kleenex are welcome.

Emmaus Visitor ☺ September, 2013 ☺ Page 4

There are many sales going on throughout Racine.

Last year we had a request to provide a supply of socks. Many of the kids come to school on rainy or snowy days without boots. Thus, their feet get wet. A dry pair of socks helps raise the level of concentration in the classroom.

Wednesday Night God Time Returns in Fall

Midweek God Time will begin on Wednesday, September 25. This program involves interactive lessons of Bible stories from the Old and New Testaments. Kids in Pre-K through grade 5 are welcome. Marcy Wieties and Diane Thygeson will offer their assistance and help plan and lead this program.

The first few weeks the kids will learn more about their impact on our world. They will study the Seasons of Creation through storms, endangered animals, oceans and the cosmos. The story of Joseph, the outcast brother who becomes the Prince of Egypt, will follow.

Registration forms are on the table in the narthex. All who are enrolled in Wednesday Night God Time will participate in the annual Christmas pageant, which is scheduled for Sunday, December 16.

Youth Birthdays

Sept. 1 Yoselin Blancarte, 3
 Sept. 2 Cooper Cacciotti, 4
 Sept. 7 Mateo Correa-Moncada, 3
 Sep. 16 Cloey Briere, 8
 Sep. 17 Christian Hernandez, 3
 Sep. 27 Juanita Martinez, 3
 Sept. 29 Valerie Soto Hernandez, 5
 Sept. 29 Valeria Maldonado, 10

Emmaus Staff & Worship Times

Church: 1925 Summit Avenue, Racine, Wisconsin 53404-2374.

emmausracine@sbcglobal.net ☒ 262 634-5515

Pastors: Rev. Mary L. Janz 1530 S. Main St. 53403 mljanz@aol.com 633-3059

Rev. Jhon Freddy Correa jhoncorrea@hotmail.com 414-881-1403

Church office: Paul Berge emmausracine@sbcglobal.net

Education Coordinator: Nancy Smith nnsdaisy@aol.com

Director Outreach: Liliana Moncada liliana.moncada@hotmail.com

President: Chris Lamberton clamberton@wi.rr.com

Accompanist: Brenda Trumbauer brenda6175@gmail.com

Custodians Antelmo Hernandez & Rich Benson

English language services are held at Emmaus Saturday evenings at 5:00, and Sunday mornings at 9:15. Spanish language worship services are offered Sundays at noon. There will be no services at Emmaus on September 8 due to the FaithWorks Fall Festival at St. Andrew Lutheran.

Emmaus office hours are 9:00 a.m. to 3:00 p.m. Monday through Friday (closed Labor Day).

The VISITOR is published monthly September to July. The deadline for the October VISITOR is September 16. Submit articles to Paul Berge's attention by mail or by e-mail.

Emmaus Visitor

Vol. 42, No. 1

September, 2013

Register for EASY/SALT by September 8

The EASY/SALT program (Emmaus After School for Youth; Serving and Learning Together) will continue to offer homework help to students in grades 1-8. Enrichment in science, math, language and vocabulary, and the creative arts is an integral part of this program. We are thankful for grants from the Siebert Lutheran Foundation, Outreach for Hope and the Racine Community Foundation whose generosity helps support these programs.



Registration Info: Registration forms are available in the narthex for both EASY and SALT. EASY, which serves grades 1-5, and SALT for grades 6-8 will kick off the year on Monday, September 23. These enrichment programs meet Monday through Thursday from school dismissal time to 5:30 p.m. There is limited space. Please return the forms to Emmaus by Monday, September 9.

SALT Welcomes New Leader

A new face will join the EASY/SALT team. Welcome Amanda Lawrence! Amanda will use her talents to lead the SALT (middle school) kids. This past summer Amanda was the SALT program coordinator at Atonement. She brings knowledge, creativity, and enthusiasm to her new role.



She has been a resident of Racine for thirty years. Amanda has worked as Account Representative/Senior Account Representative for Market Day Corporation. She is a massage therapist and has chaired the Racine Art Guild Starving Artist Outdoor Art Fair since 2009.

EASY/SALT Parent Meeting Set

On Tuesday, September 17, there will be a mandatory meeting for parents of kids enrolled in the EASY/SALT program. To allow for work schedules, two times are being offered: 10:00 a.m. and 7:00

p.m. The meeting will be conducted in English and Spanish. This time of orientation will allow the staff to explain in detail the program and address any questions that parents may have.

Emmaus Visitor ☺ September, 2013 ☺ Page 6

Neighborhood Campers Read 920 Books

One of the highlights of the closing program: each camper and staff member received a "Peace Begins With Me" t-shirt.



Neighborhood Camp is possible because of a wonderful and supportive staff. Erik Skaarnes became the assistant to the coordinator, Nancy Smith, just a week before camp began. He learned his role quickly and led the younger campers who were under the guidance of Anthony Medina, Courtney Royster and Katie Syslack. Jose Reyes, Jessica Luis, Jenn Haman and Anthony Figueroa kept the older campers on task. Thanks to their leadership the campers had a fun and exciting summer! There is no doubt that they grew in the knowledge of Christ's love.

Barnes & Noble supported Campers with "Books have wings." Books take you to places you have never been. The campers hear these quotes a lot. Ann Marie

Pilot, the community coordinator for B&N, gifted over 115 books to the kids during the closing program.

For every eight books a camper read, they received a free book of their choice. Campers read 920 books. That's a lot of books to move in and out of a small space in such a short time.

This reading program is a coordinated effort between the staff and the librarian. This summer, Barb Larsen spent many hours in the Emmaus library. With her support the campers checked books in and out of the library several times per



day. She helped catalog and shelve books. She helped the kids fill in their B&N reading forms. Thank you, Barb!

➔ Please turn to page 8

Emmaus Visitor ☺ September, 2013 ☺ Page 7

Mentors Befriend EASY Kids

Won't you please be a mentor? This program has become a strong and meaningful part of the EASY (Emmaus After School for Youth) program. What a friend we have . . . Wow! The kids do look forward to spending time with a mentor. Last year's mentors can vouch for this!

A mentor spends one afternoon a week helping their



special friend with homework. It is also a time for playing games and working with them in the areas of math, reading, and language. Part of the mentoring program is to encourage the kids to be all that they can be. Conversation and small talk do help build relationships. Goal: a mentor for every EASY kid! See Nancy Smith.

Neighborhood Camp

→ Continued from page 7

Campers Reach Out/Give Generously: This summer the campers decided they would support not one but two different causes. They wanted to help Stop Malaria and also provide funding so that science equipment could be purchased for the students in Tanzania. The campers brought in loose change and recycled

aluminum cans. They campaigned for these causes by placing "Want Ads" around the church.

The response was good! At the closing program the campers presented two checks to George Corliss, a representative of the Milwaukee ELCA Synod Stop Malaria campaign, for a total of \$655.

Knit One Purl One Picks Up Needles September 30

Knit 1 Purl 1 resumes weekly meetings beginning Monday, September 30 at 10:00 a.m. Anyone interested in knitting and/or crocheting is welcome. Come and see! Prayer shawls, children's hats, mittens



and scarves are some of the items that the group creates.

You can expect not only knitting, but laughter and engaging conversations revolving around many different topics.

Emmaus Visitor ☞ September, 2013 ☞ Page 8

Letters:

St. Monica's Residents Thank SALT Visitors

Dear Ms. Moncada,

What can I say but thank you to you and all the youths that participated this year from your SALT program. These young people were terrific in their participation with our residents. They were great listeners and very good with the interaction.

Many of our residents do not have an opportunity to visit with young people, so it is always a special treat to have well mannered, nice youths here visiting. I wish you could have seen the positive energy during the last hour of visiting in our living room. At one point, our WWII

Veteran had several of your boys mesmerized with his tales and his helmet that had a bullet hole in it!

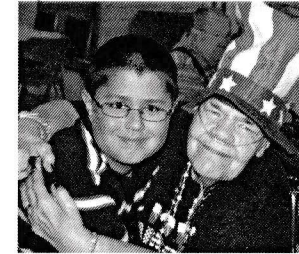

We know it takes time and coordination to plan these events, and it is really appreciated. Again,

watching, listening and interacting with these children means so much to our residents.

Again, please extend our appreciation to the young visitors and your talented staff for their involvement with St. Monica.

Sincerely,
Joan Windis, Activities Department

Svensden Family Appreciates Years of Friendship

The family of Al Svensden would like to thank the Emmaus community for all of your support, love and friendship over the past years, but especially the last few months. You can contact Al at 949 Sibley Memorial Highway #101, Lilydale, MN 55118, 262-930-7830.

Please call or visit if you are in the Twin City area. Efforts are being made to set up Al on Facebook and Skype so he can stay in contact more easily.

Sincerely,
Sharon Wanvig

Search for Saturday Accompanist Is Underway

We are searching for a pianist to accompany the Saturday worship service. Please contact

Pastor Mary, Brenda Trumbauer, or Kathy Christensen if you or someone you know are interested.

Emmaus Visitor ☞ September, 2013 ☞ Page 9

ELCA Elects Elizabeth Eaton Presiding Bishop

PITTSBURGH (ELCA) — The Rev. Elizabeth A. Eaton, bishop of the Evangelical Lutheran Church in America (ELCA) Northeastern Ohio Synod, was elected August 14 Presiding Bishop of the ELCA at the 2013 ELCA Churchwide Assembly. She was elected on the fifth ballot. There were 889 votes cast, and 445 votes were needed for an election. Eaton received 600 votes and the Rev. Mark S. Hanson, ELCA presiding bishop, received 287. Eaton is the ELCA's first woman presiding bishop-elect.

The church-wide assembly, the chief legislative authority of the ELCA, met August 12-17 at the David L. Lawrence Convention Center in Pittsburgh. The theme for the triennial assembly was "Always being made new." This year marks the 25th anniversary of this church.

"We are a church that is overwhelmingly European in a culture that is increasingly pluralistic. We need to welcome the gifts of those who come from different places. That is a conversation we need to have as a

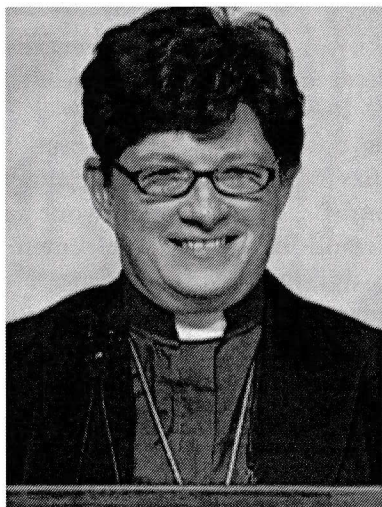

church," Eaton told the assembly shortly after the election.

Eaton expressed some surprise at her election, telling the assembly that she had allowed her name to be put forward because "I just wanted there to be a conversation. I didn't think it would get this out of hand."

Current Presiding Bishop Mark Hanson has served two six-year terms in the office.

"When I stood before you twelve years ago, I told you this is not an election won, this is a call received. And now this call has been extended to Bishop Eaton," Hanson said at the assembly. "This is a humble and a holy privilege to serve

the Gospel as the pastor of this whole church."

Prior to becoming synod bishop, Eaton served as pastor for ELCA congregations in Ohio. She earned a Masters of Divinity degree from Harvard Divinity School in Cambridge, Mass., and a Bachelors degree in music education from the College of Wooster in Wooster, Ohio. Bishop Eaton's husband, the Rev. Conrad

➔ Please turn to page 21

September Worship Leaders

	Altar Guild	Communion Assts.	Readers	Ushers
Sat. Aug. 31 5:00 pm	Brian & Denise Keller	—	—	—
Sun. Sep. 1 9:15 am	Bev Hansen Audrey Villalobos	Kathy Christensen	Amy Haman	Team 3
Sat. Sep. 7 5:00 pm	Cathy Meyer Linda Clinton	—	—	—
Sun. Sep. 8 @ St Andrew	Barb Larsen Pat Jensen	Carol Eschmann Nancy Smith	Jim Larrabee	Team 4 W. Meteyard
Sat. Sep. 14 5:00 pm	Barb Toslek Jamie Toslek	—	—	—
Sun. Sep. 15 10:00 am	Joy Lippmann Marge Jensen	Pat Jensen	Ron Jensen	Team 5 M. Porcaro
Sat. Sep. 21 5:00 pm	Cheryl Dexter	—	—	—
Sun. Sep. 22 9:15 am	Kathy Christensen Marlyn Christensen	Diane Melander Joy Lippmann	Cindi Larsen	Team 1
Sat. Sep. 28 5:00 pm	Marge & Amy Zielke Missy Porcaro	—	—	—
Sun. Sep. 29 9:15 am	Caren Lamberton	Karen Sedgwick K. Christensen	Jen Haman	Team 2 Christensen
Sat. Oct. 5 5:00 pm	Judy Berndt Linda Meteyard	—	—	—
Sun. Oct. 6 9:15 am	Barb Larsen Pat Jensen	Shirley Velzka	Melissa Lemke	Team 3

Pick Up Your Fall Envelopes in Narthex

The next set of offering envelopes will be made available for members to pick up in the narthex. The October to January envelope set should be available early this month.

We will continue to mail a few offering

envelope sets to those shut-ins and far away members who contribute regularly. We will not order envelopes for those members who seldom or never use them, although we will have some blank sets on hand for new or reactivated contributors.



Sunday	Monday	Tuesday	Wednesday	Thursday	Friday	Saturday
7 15 TH SUNDAY AFTER PENTECOST 9:15 am Worship service w/Holy Communion (English) 10:30 am Coffee & fellowship 10:30 am Blood pressure testing 10:30 am Coach group 12:00 noon Santa Misa (español)	2 LABOR DAY <i>Offices closed</i> 	3 5:00 pm TOPS 6:00 pm GED class	4 12:00 noon J. Clark funeral at Sturino	5 ROSH HASHANAH 11:00 am Sun. bulletin deadline 4:00 pm BENNU legal appointments 6:00 pm GED class	6 6:00 pm Support group	7 12:00 noon FaithWorks Fall Festival at St. Andrew, to 8:00 5:00 pm Worship service with Holy Communion (English)
----- <i>Pastor Mary's week off</i> -----						
8 16 TH SUNDAY AFTER PENTECOST; GRANDPARENTS' DAY 10:00 am FaithWorks joint worship service w/Holy Communion at St. Andrew Lutheran (bilingüe) 11:30 am FaithWorks Fall Festival at St. Andrew Lutheran, to 6:00 pm	9	10 1:30 pm Clergy meeting 5:00 pm TOPS 6:00 pm Church council mtg. (español) 6:00 pm GED class	11 PATRIOT DAY 1:30 pm Lydia Circle 	12 11:00 am Sun. bulletin deadline 6:00 pm GED class 	13 6:00 pm Support group 	14 HOLY CROSS; YOM KIPPUR 1:00 pm Barajas quinceañera 5:00 pm Worship service with Holy Communion (English)
15 17 TH SUNDAY AFTER PENTECOST 8:30 am Musicians' rehearsal 9:15 am Chicago Folk Service (English) with Holy Communion 10:30 am Coffee & fellowship 10:45 am Q&A (English) 12:00 noon Santa Misa (español) 12:30 pm Sunday School (bilingual)	16 MEXICAN INDEPENDENCE DAY 	17 CITIZENSHIP DAY 10:00 am EASY parent orientation 5:00 pm TOPS 6:00 pm GED class 6:30 pm Church council mtg. (English) 7:00 pm EASY parent orientation	18	19 SUKKOT 11:00 am Sun. bulletin deadline 4:00 pm BENNU legal appointments 6:00 pm GED class	20 6:00 pm Support group	21 ST. MATTHEW 1:00 pm Fabiola quinceañera 5:00 pm Worship service with Holy Communion (English)
22 18 TH SUNDAY AFTER PENTECOST 9:15 am Worship service w/Holy Communion (English) 10:30 am Coffee & fellowship 10:30 am Coach group 10:45 am Congregational meeting 12:00 noon Santa Misa (español) 12:30 pm Sunday School (bilingual)	23 3:00 pm EASY	24 3:00 pm EASY 5:00 pm TOPS 6:00 pm GED class 7:00 pm Fireside Exchange	25 3:00 pm EASY 5:15 pm Supper 5:30 pm Wednesday God Time 6:30 pm English conversation	26 11:00 am Sun. bulletin deadline 2:00 pm N. Side food pantry 3:00 pm EASY 6:00 pm GED class	27 6:00 pm Support group 	28 ST. WENCESLAUS 5:00 pm Worship service with Holy Communion (English)
29 19 TH SUNDAY AFTER PENTECOST; ST. MICHAEL & ALL ANGELS 9:15 am Worship service w/Holy Communion (English) 10:30 am Coffee & fellowship 10:30 am Coach group 12:00 noon Santa Misa (español) 12:30 pm Sunday School (bilingual)	30 10:00 am Knit One, Purl One 3:00 pm EASY	Oct. 1 3:00 pm EASY 5:00 pm TOPS 6:00 pm GED class	2 3:00 pm EASY 5:15 pm Supper 5:30 pm Wednesday God Time 6:30 pm English conversation	3 11:00 am Bulletin deadline 3:00 pm EASY 4:00 pm BENNU legal appointments 5:00 pm Community Meal at St. Patrick's 6:00 pm GED class	4 6:00 pm Support group	5 5:00 pm Worship service w/HC (English)

Building Repairs Are Ongoing

Repair has recently been completed to address the various areas of the roof where there has been considerable leakage. Ceiling tiles have been replaced in the main office and the two pastors' offices.



Ongoing issues with the double glass doors at the front and the back of the church are becoming more and more difficult to remedy due to the age and the style of the doors. This has led to a security concern, as there are times when the doors have not securely locked when closed. The doors and locks are being assessed, and estimates have been requested for the replacement of the doors. When information has been gathered, the church council will discuss a solution to the problem. It is hoped that more information will be available to be shared at the congregational meeting, which is scheduled for September 22 at 10:45 a.m.

The elevator has been out of commission for almost two weeks due to a burned out circuit board. The original parts sent were not compatible with our elevator, which delayed the repairs, and the circuit board required reprogramming. Work is still in progress at press time. Although we have not received the final bill, it is estimated that the repairs will be in excess of \$2,500.00. Special gifts are welcome to help defray the cost of the unexpected repairs.

September Birthdays: 70 Years and Better

Sep. 1	Kathy Christensen	1019 Highway V, Sturtevant	53177
Sep. 2	Gerry Dykstra	1521 Summit Avenue	53404
Sep. 7	Betty Woodward	2333 Arlington Avenue	53403
Sep. 10	Catherine Miller	2704 James Boulevard	53403
Sep. 15	Dorothy Bagley	5215 Douglas Avenue, #108	53402
Sep. 25	Bob Mathieux	1716 Warwick Way	53406

Readings for September

Sept. 1: Proverbs 25:67; Psalm 112; Hebrews 13:1-8, 15-16; Luke 14:1:7-14.
 Sept. 8: Deuteronomy 30:15-20; Psalm 1; Philemon 1-21; Luke 14:25-33.
 Sept. 15: Job 39.1-12, 26-30, Psalm 104.14-23, 31, 1 Corinthians 1.10-23, Luke 12.22-31.
 Sept. 22: Proverbs 8:22-31, Psalm 104:24-26, Colossians 1:15-20, John 6:41-51.
 Sept. 29: Job 38:1-18, Psalm. 104:24-26, Ephesians 1:3-10, Luke 5:1-11.

Emmaus Visitor ☺ September, 2013 ☺ Page 14

Thank You to Community Meal Casserole Makers

Thank you to all the Emmaus members who pitched in to make salads, and desserts for the August 1 Community Meal at St. Patrick's. Mary Jenkins from St. Andrew Lutheran called afterward to tell

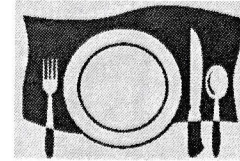

our Community Meal volunteers that "everyone just loved your salads!"

Our next turn to serve the Community Meal will be on October 3. Look for a sign-up sheet in the narthex in September.

CROP Walkers Help Fight Hunger

Many families continue to struggle to feed their children during this time of high unemployment. Food pantry shelves are emptying quickly to keep up with the need. So please, save the date of Sunday, October 13 for Racine's 2013 CROP (Christian Rural Overseas Program) Hunger Walk.

This walk helps to support our local food pantry and hunger worldwide. Just \$500 of donations can provide 4,000 pounds of food for a local food bank.

How can you help? You can support the walk by walking, and getting pledges from others. If you aren't a walker, that's OK! We need your help by donating to the walk or you can support walkers by pledging to their walk.

Racine County Food Bank receives 25% of the funds raised

with the remainder assisting refugees and hungry populations through Church World Services. Last year's walk raised \$1,000.00 to the Racine County Food Bank.

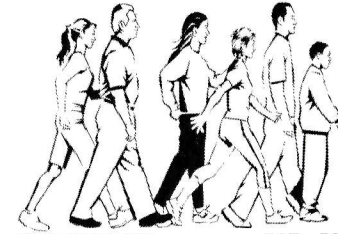

CROP Hunger Walk

If you will help, watch the table for coffee on Sunday morning for forms to sign up to walk or to donate. If you have questions or want to help, contact Diane Melander at 262-412-2070 or email her at ironoreflicka@mac.com.

Memorial & Honoraria

Non-designated honoraria:

In honor of Clara Harris Larsen: \$100.00

In honor of Rich & Kathy Christensen: \$370.00

Non-designated memorials:

In memory of Harris Larsen: \$100.00

Emmaus Visitor ☺ September, 2013 ☺ Page 15

Leaders Gear Up for Fall Stewardship Campaign

Plans for a fall stewardship campaign, culminating in a November celebration on Consecration Sunday, are now underway. Stewardship chair Carolyn Wooster, together with Treasurer Art Smith, have met with members of St. Andrew to begin planning the joint campaign.



While each congregation will conduct their individual campaigns, leadership will be shared, and the November 17 worship and meal will be a joint celebration. Watch for more details about how you can be a part of this very important time in the life of the church!

Lincoln Lutheran Seeks HR Volunteer

By Melissa E. Greiner

Lincoln Lutheran has an immediate opening for a volunteer to assist in the Human Resources and Agency Advancement Departments in its administrative offices at 2000 Domanik Drive. The person must be energetic and have a flexible schedule and be willing to commit 2 to 4 hours every week,

Monday - Friday between the hours of 8:00 a.m. and 4:30 p.m. To be considered for this position, please complete a volunteer application which can be found at: www.lincolnlutheran.com/volunteer-opportunities. Questions? Visit www.lsswis.org.

Crunching the Numbers

Weekly worship attendance averages (calculated as of Aug. 25, 2013)

	2011				2012			2013		
	Sat	Sun	dom	Wed	Sat	Sun	dom	Sat	Sun	dom
Jn	16	50	171	—	13	48	143	16	49	113
Jl	13	46	128	—	15	53	127	23	46	134
Au	21	49	119	—	9	39	138	14	40	136
Se	17	65	194	83	11	43	199			

Financial Figures

Total for month 2013 to date
 General Fund offerings received in June 2013: \$9,895.93 }
 General Fund offerings received in July 2013: \$11,937.07 } \$87,133.19

Mortgage retirement offerings received in June '13.....	\$140.00	
.....in July '13.....	\$150.00	Campaign TD: \$73,052.62
Mortgage payments in July-Aug. 2013: Principal	\$2,575.56	Principal balance as of
Interest.....	\$400.44	August 14, 2013:
Total.....	\$2,976.00	\$25,401.24

Northside Food Pantry Volunteer Schedule

September 26: June Beck, James Larrabee, Boots LeRoux, Art Smith
 October 24: James Larrabee, Pat & Ron Jensen, Rich & Kathy Christensen

Fall Festival

Continued from page 3

from \$50 to \$1,000, as well as several other items from church members and corporate sponsors, will be raffled off.

The Care Abounds in Community program of Thrivent Financial for Lutherans has also announced that the FaithWorks Fall Festival has been approved to receive matching funds for the two-day event. Thrivent will match festival proceeds at a one-for-three level, up to a maximum of \$1,600. Earnings will then be divided among the ELCA Latino ministry in Racine and FaithWorks, to be used for community outreach ministries,

including helping educate children and feeding the hungry of Racine.

The festival is sponsored by the FaithWorks ELCA congregations of Racine: Emmaus/ Emaús, Atonement East and West,



at St. Andrew Lutheran Church
 1015 Four Mile Road

Saturday, September 7 12:00 to 8:00 p.m.
 Sunday, September 8 10:00 a.m. to 6:00 p.m.

Bilingual worship service at 10:00 a.m. Sunday
 Misa bilingüe el domingo a las 10

Raffle, games, music, bake sale, and more!

¡Juegos, música, comida, bailables, rifas y más!



El dinero recaudado será utilizado en programas comunitarios. Proceeds to feed the mind, body and soul of the Racine community.

FaithWorks is a partnership of Atonement East & West, Emmaus, Our Savior's, Redeemer, and St. Andrew Lutheran Churches.

Redeemer, Our Savior's and St. Andrew. See our web site at <http://www.faithworksracine.wordpress.com>, and look us up on Facebook.

Downtown Shelter Seeks Volunteers

By Pat Liesch

The Hospitality Center, located in St. Luke's Episcopal Church, corner of 7th and Main, will again provide emergency shelter for the most vulnerable when winter temperatures become so cold that frostbite and death can occur. The Center is looking for individuals and /or groups to volunteer for this life saving emergency shelter overnight

program.

Volunteers are needed for supper, breakfast, evening and overnight hours. For those of you that volunteered for the REST program in the past, this is similar except for a much smaller population. Please contact Kevin Stewart at 414-405-5619 to learn specifically how you can serve and help to save lives.

Environmental Stewardship

Does Climate Change Bug You?

by John Berge

I have frequently written about the problems of climate change -- specifically global warming -- due to man-made increases in carbon dioxide levels in the air. Recent readings of nearly 400 ppm are the highest in the last 6000 years and probably since the age of the dinosaurs! But I haven't written much about the relationship of these changes with public health.

Last January, Yale University's Climate and Energy Institute held a forum of 90 scientists from across the country, "Integration of Climate Change and Infectious Disease Research." While many direct impacts of climate change on non-contagious diseases such as

heat stroke and respiratory diseases have been well documented, much less research has been done on infectious diseases such as influenza, malaria, West Nile virus, and Lyme disease.

Increasing temperatures are bringing tropical and semi-tropical vector-borne diseases further north.

(Vector-borne means the disease causing organism is carried to its victims by such pests as mosquitoes and ticks.) Dr. Maria Diuk-Wasser of the Yale School of Public Health has documented increases and northern migration of diseases such as Lyme disease, West Nile virus, dengue fever and babesiosis. (Babesiosis was a new

➔ Please turn to page 19

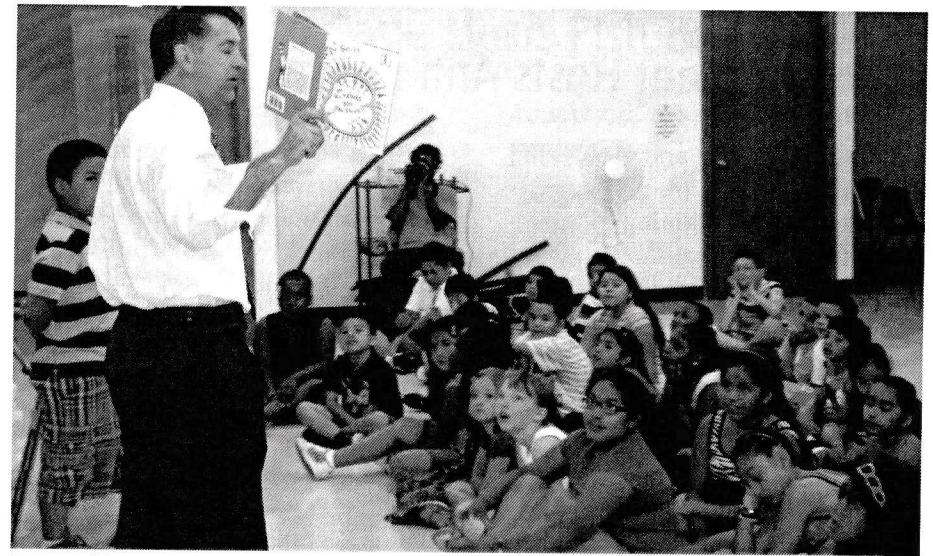
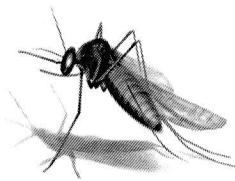

Racine Mayor John Dickert reads from Dr. Seuss to Neighborhood Campers in July.

Environmental Stewardship

➔ Continued from page 18

disease for me; it is transmitted by ticks and attacks the red blood cells, even to the point of causing anemia in some people, especially the elderly or those with lowered immune systems.) Lyme disease is now the most commonly reported vector-borne disease in the nation.

So how does this all relate to environmental stewardship? It is one more very important reason to reduce our dependence upon fossil fuels for our energy needs. Renewable forms of energy and energy efficiencies are the best ways to accomplish this reduction in carbon dioxide production.

Secondly, we should protect ourselves from the vectors that carry the micro-organisms to us.

Mosquitoes and ticks top the list. Repellants, mosquito netting, screens, choosing better times to be in hazardous places are better protection than wholesale use of insecticides that kill the good insects along with the varmints. By the way, nasty as they are, bed bugs are not known to be a vector for any human diseases.

Follow Emmaus on Facebook

Check out photos and keep up to date on the latest news. Type



Emmaus-Racine into the Facebook Search bar, or use your smart phone to scan the QR code at left.

Atonement Hosts Anti-racism Training

Understanding and Analyzing Systemic Racism (A Crossroads Antiracism Training and Organizing Workshop), for rostered, synod, and congregation leadership who are of European descent or are people of color: September 19 - 21. Thursday (5:00-9:30 p.m.) Friday (8:30 a.m. - 6:00 p.m.) Saturday (8:30 a.m. - 4:00 p.m.) at Atonement Lutheran Church, 2915 Wright Avenue, Racine.

\$125 for ELCA participants, \$175 for Non-ELCA participants. Costs includes materials and food. Scholarship assistance available upon request on the registration form.

Registration form available at milwaukeesynod.org; click events, and then this workshop entry. Registration deadline September 11.

Support Outreach for Hope Bike Ride

Go to www.outreachforhope.org and click on the "Bike Ride" tab for the official website to become informed about the Outreach for Hope Family Bike Ride, September 7 at St. Bruno in Dousman. Please prayerfully consider supporting this amazing event. Visit the Outreach for Hope



To receive more details or if you have questions, please contact the following of the Greater Milwaukee Synod's Anti-Racism Team: Mr. Jerry Key, (414) 465-0352 or keyju@matc.edu or Rev. Chuck Ruehle, (262) 886-3286 or chuck.ruehle@yahoo.com

Understanding and Analyzing Systemic Racism has been one of two introductory workshops on systemic racism offered by the Greater Milwaukee Synod Anti-Racism Team. The Zimmerman trial in Florida involving the killing of Trayvon Martin and the John Spooner trial in Milwaukee involving the murder of ELCA member Darius Simpson are two of the worst recent manifestations where the presence of systemic racism informed a destructive personal response.

web site for information about the wonderful ministries your donation will impact.

Go to the same web site to donate. No need to ride. Donations received will be matched by a generous challenge grant. Your contribution is needed now. Support ministries in the most challenging neighborhoods of our Synod.

North Cape Hosts Fish Boil

North Cape Lutheran Church invites you to their All-You-Can-Eat fish boil Saturday, September 28, 3:30-8:00 p.m. Advance tickets are \$12.00 for adults, \$5.00 for children ages 6-11, and free for children 5 and under. Tickets at the door are \$13.00 for adults, \$6.00 for kids 6-11. Reservations are accepted for groups of ten or more

The menu includes boneless, skinless ocean cod smothered in butter (or margarine on request); new jacketed potatoes, boiled carrots and onions, homemade

dessert and a beverage. Watch the masters cook the meal outdoors over an open wood fire while "Danny Crivello Group" provides musical entertainment.



Proceeds will be used for church ministries and outreach activities. For information or reservations, call the church office, 835-2206 mornings.

North Cape Lutheran is located on the east side of Highway 45 between Highway K and Five Mile Road.

Churchwide Assembly

→ Continued from page 10

Selnick, is an Episcopal priest. They have two grown daughters.

Social Statement

On Friday the assembly voted to adopt a social statement, "The Church and Criminal Justice: Hearing the Cries" with a 882 to 25 vote.

The statement affirms the fundamental principles of the U.S. criminal justice system, such as due process of law and the presumption of legal innocence, and it also recognizes serious deficiencies: overly harsh sentencing and persistent inequalities based on race and class.

It calls ELCA members to accompaniment, hospitality and advocacy. It asks members of this church to recommit themselves to visiting the prisoner; to correcting the flawed criminal justice system; to participating in God's work with hands and hearts, and to hearing the cries of people affected.

ELCA social statements are teaching documents that assist members in forming judgments on social issues. They set policy for this church and guide its advocacy and work as a public church.

The social statement on criminal justice is on line at www.ELCA.org/criminaljustice.

Love, Peace and Freedom

Several weeks ago, the campers concluded their summer experience with a canoe trip on the Root River. The day started with the threat of rain, but the weather did not dampen the spirits of the kids. Shortly after noon, the sun began to peek through the clouds. As the older campers were



paddling up the river, you could hear them call out, sharing with each other the sightings of turtles, birds and the rocks and fallen trees. Some were amazed at the root systems of trees that were bared by raging high waters. For some paddling in a straight line was a challenge. Yes, there were a few shrieks as a canoe veered toward the river's bank.

The campers paddled upstream negotiating gentle bends in the river. When it came time to turn around and head back to River Bend, some paddled quickly and disappeared. Others wanted to slow down and enjoy the

moment. Five canoes ended up side by side and floated slowly downstream for about 20 minutes. The campers were content to be in the moment.

Several commented about how peaceful it was. Out of the blue a small clear voice was heard. One of the campers started to sing,

*"I've got peace like a river,
I've got peace like a river,
I've got peace like a river in my soul."*

By the second line of this well-known song, every camper

was singing with unabashed gusto. The staff was all smiles and quite taken that we were witnessing such a love and peace filled moment.

Love, peace and freedom: the theme of peace was woven throughout the five weeks of camp. The campers had opportunities to describe their thoughts on peace through poetry, story and art. They made mala peace bracelets out of glass beads that they wore each day of camp. During God Time they learned to share that special feeling by greeting one another with a high

→ Please turn to page 23

→ Continued from page 22

five "Shalom" followed by the sign of "Peace." Throughout the day, you could hear "Shalom, Peace" as campers and staff greeted one another in the morning and passed one another in the hallways.

At the closing program, the campers sang "Love, Peace and Freedom." There they stood, black, white, and brown, in front of proud parents and friends, singing and signing the refrain, "Singing for the healing, for the love that we are feeling,

Sing love, peace and freedom for us all."

One particular verse in this song says, "Sing to a vision for all races, all religions, Sing love, peace and freedom for us all."

Let us not forget that fifty years ago, Martin Luther King, Jr. stood before a peaceful multitude of all races, all religions at the Lincoln Memorial in Washington DC and spoke those memorable words, "I have a dream today! ... Let freedom ring!"

King went on to say, "And when this happens, and we allow freedom ring, when we let it ring from every village and every

hamlet, from every state and every city, we will be able to speed up that day when all God's children, black men and white men, Jews and Gentiles, Protestants and Catholics, will be able to join

hands and sing in the words of the old Negro spiritual:

'Free at last!
Free at last!
Thank God almighty, we are free at last!'"

Faith transforms. I was blessed to

witness a summer of transformation in the lives of our campers. They came the first day some confident, some shy and timid, some overwhelmed by a new place and new faces. In five fun-filled and mentally stimulating weeks, they became a group of caring and thoughtful kids who could work together for love, peace and freedom. I give thanks to God who renews us each day with an abundance of love. I give thanks to Christ, the Prince of Peace, who challenges us with his teachings and his life to bring peace and freedom for us ALL!

Shalom, Peace!

Nancy



In the September Visitor:

- ✠ FaithWorks Fall
Festival, Sept. 7 & 8
- ✠ Season of Creation
- ✠ Wednesday Night
God Time
- ✠ Register for EASY,
SALT Programs
- ✠ Amanda Lawrence
to Lead SALT Program
- ✠ ELCA Elects Eaton
Presiding Bishop
- ✠ Elevator, Roof Work
- ✠ CROP Walk Oct. 13
- ✠ Love, Peace and
Freedom

Emmaus Evangelical Lutheran Church
1925 Summit Avenue
Racine, Wisconsin 53404-2374

Change service requested

Non-Profit Org.
U.S. Postage PAID
Racine, WI
Permit No. 137

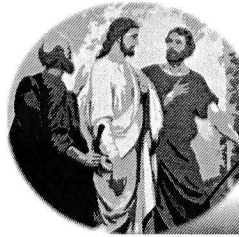

Emmaus Visitor

October, 2013

Emmaus, St. Andrew Vote to Share Worship

In a spirit of collaboration, members from both Emmaus and St. Andrew voted at their respective congregational meetings on September 22 to begin worshipping together on the weekends. The vote followed give-and-take conversations at Question and Answer sessions held at both churches the previous week.

While there are some givens, a number of details are still to be worked out. Both groups approved adopting the current St. Andrew worship times of 4:30 p.m. Saturday and 9:00 a.m. on Sundays. Brenda Trumbauer will be the primary musician on Sundays, and a search is taking place for a Saturday musician.

The services will rotate between St. Andrew and Emmaus, most likely on a monthly basis. Pastor Mary and Pastor Michael

will each preach half of the weekends during a given month.

A task force will meet at St. Andrew at 6:00 p.m. Tuesday,

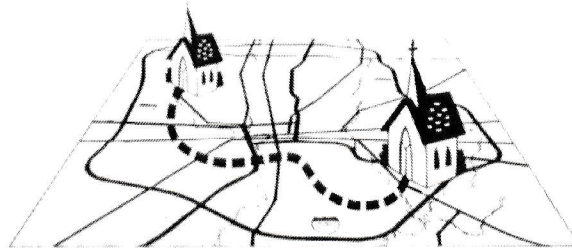

October 8 to discuss further details. The pastors, representatives of the council, and members of the worship planning teams will be part of the final decision making team. A start date (very likely Reformation Sunday, October 27), scheduling, and logistics concerning loose offering, altar guild, lay ministers, and overall communication will be among the items discussed.

In mid-October, there will be a mass mailing to all households of

↳ Please turn to page 2

Emmaus Evangelical Lutheran Church
"Sent Forth by God's Blessing"
e-mail: emmausracine@sbcglobal.net
<http://www.emmaus-racine.org>

1925 Summit Avenue
Racine, Wisconsin 53404
Phone: 262 634-5515
Fax 262 634-0835

Pastoral Acts

<p>Baptisms: Noelia Garduño Janelle Garduño Vivian Garduño September 14, 2013</p>	<p>Noelia, 11, Janelle, 7, and Vivian, 1, are daughters of Nancy Murillo and Fausto Garduño. Noelia's sponsors are Everardo and Maria V. Oviedo. Janelle's sponsors are Celedonio and Sonya Soto. Vivian's sponsors are Arturo and Sylvia Rodriguez.</p>
<p>Gabriel James Carrasquillo September 22, 2013</p>	<p>Gabriel is the infant son of Tina Yust and Rafael Carrasquillo, Sr., and grandson of Carol Yust. His sponsors are Seth and Julie Yust.</p>
<p>Funerals: June Matson Clark September 4, 2013</p>	<p>An aunt of Judy Yorgan, Mrs. Clark was a lifelong resident of Racine. She enjoyed playing the piano and organ, and going on motorcycle trips with her husband, Clayton, who died in 2001.</p>
<p>Marcella Sorensen Runge September 13, 2013</p>	<p>Marcie, widow of Walter Runge, passed away September 8 at age 97. She had been a member of Mary Circle at Emmaus. She is survived by daughters Jane (Jeffrey) Uecker and JoAnn (Thomas) Henrickson, grandchildren and great-grandchildren.</p>

Shared Worship

→ Continued from page 1

both congregations, providing information and detailing a schedule for the remainder of 2013.

At our congregational meeting, it was asked what we would call ourselves as a worshipping community. For the time being, we will be known as FaithWorks North, with a possibility of a new name be adopted at some time in the future. At this time, however, all finances

for Emmaus and St. Andrew will be handled separately, and we will continue to use our current offering envelopes, which will be forwarded to the designated congregation.

Stay tuned for details! Meanwhile, keep the wider work of FaithWorks and the collaboration between St. Andrew and Emmaus in your prayers.

Wine Tasting Party Moves to Wind Point

Wind Meadows Leisure Center (off Campus Drive when turning east from North Main Street) has been chosen as the venue for this year's wine tasting party. There is ample parking, and the building is accessible. Hours for the event are 4:00 p.m. to 8:00 p.m.

A \$25 donation entitles a person to several samples of wine,



micro beer or soft drinks as well as food. Donations of raffle basket items or appetizers for the event are welcomed. This fun evening is an opportunity to get together with others socially while supporting Emmaus.

Thrivent Financial for Lutherans will provide matching funds for the event. Tickets are available at the church office.

CROP Walk Aids Local Food Bank

Let's help fight hunger by supporting Racine's annual CROP Hunger Walk. It is scheduled for Sunday, October 13.

This walk helps to support our local food pantry. Just \$500 of donations can provide 4,000 pounds of food for our local food bank.

You can support the walk by walking, and getting pledges from others, or by making a donation. The walk begins at St. Luke's Episcopal Church, on the corner of Seventh and Main. Registration begins at noon and the walk starts at 1:00 p.m.



If you want to help the walk, you may sign up to walk, or you may donate at the coffee sale table during coffee hour.

Everyone is welcome to participate. Envelopes for walkers' pledges and the walk route are available in the church narthex, or during coffee time.

The CROP Hunger Walk is sponsored by Church World Service. If you have questions or want to help, contact Diane Melander at 262-412-2070 or e-mail her at ironoreflicka@mac.com

Sewing Group Resumes

The sewing group will gather at 10:00 a.m. on Monday, September 30 in the fellowship hall. We plan to make quilts for LWR (Lutheran World Relief). Much like the fleece blankets, we can use everyone to help; no experience needed. Needed are willing hands to cut, pin, stitch and tie. Join us for conversation and stitching. We are also accepting donations of

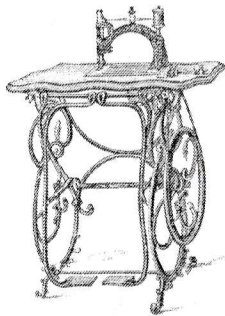

fabric and sheets of any size. If you have questions, phone or email Kathy Christensen or Carol Eschmann.

Lydia Circle Meets October 9

The women's afternoon Bible study group will meet at 1:30 p.m. Wednesday, October 9. All women of the church are invited to participate.

Memorials & Honoraria

Non-designated honoraria:

In honor of Rich & Kathy Christensen: \$100.00

Designated for Northside Food Pantry:

In honor of Rich & Kathy Christensen: \$25.00



Emmaus Staff & Worship Times

Pastors: Rev. Mary L. Janz 1530 S. Main Street, 53403 262/633-3059
Rev. Jhon Freddy Correa 1909 Summit Ave. 53404 414/881-1403

Council President: Chris Lamberton clamberton@wi.rr.com
Education Coord.: Nancy Smith nnsdaisy@aol.com
Director Outreach: Liliana Moncada liliana.moncada@hotmail.com
Church office: Paul Berge emmausracine@sbcglobal.net
Accompanist: Brenda Trumbauer brenda6175@gmail.com
Custodians: Antelmo Hernando & Rich Benson

English language services are held at Emmaus every Saturday evening at 5:00, and Sunday mornings at 9:15. This schedule is due to change in November; please follow us on Facebook or at emmausracine.wordpress.com. Spanish language worship services are offered Sundays at noon.

Emmaus office hours are 9:00 a.m. to 3:00 p.m. Monday through Friday.

The VISITOR is published monthly September to July. The deadline for the November VISITOR is October 15. Submit articles to Paul Berge's attention by mail or by e-mail.

Emmaus Visitor Vol. 42, No. 2 October, 2013

Kids to Enjoy Time at Farm

Kids of Emmaus have been invited by Gordie, Danny and Kris Johnson to have some pre-Halloween fun at their farm. This excursion will take the place of our regular Wednesday



night meal and God Time for kids on October 30. Adults willing to provide rides to the kids, leaving the church at 5:00 p.m., should contact the church office or Nancy Smith.

Wednesday Night Activities Off to Strong Start

Thirty-three eager first through fifth graders have begun another season of EASY (Emmaus After School for Youth). Their parents attended orientation meetings prior to the September 23 beginning of the program, learning about the expectations and hopes for this year.

The Monday through Thursday program stresses homework help and enrichment, with the areas of hands-on science, math, reading, art and computers having special attention. Headed by Nancy Smith and Diane Thygeson, there is a staff that works with the kids on a daily basis.

It is the goal that each of the 33 students have a mentor who will come to spend an hour each week with them, helping with homework, reading a book from the library, playing a game, and simply building a healthy relationship. Interested Emmaus members and friends are

encouraged to contact Nancy Smith (262-672-5859 before 2:00 p.m.) to learn more.

The SALT (Serving and Learning Together) Middle School Program is comprised of twelve middle schoolers led by Amanda Lawrence. Enrollment for the two programs is at full capacity.



Youth Birthdays

Oct. 1	BrookLyn Madala	3
Oct. 1	Ben Torine	12
Oct. 5	Emilio Espinoza	7
Oct. 8	Edgar Munoz	9
Oct. 9	Nevaeh Dominguez	9
Oct. 10	Nalleli Becerra	5
Oct. 13	Mae Perkins	5
Oct. 14	Jacari Tussler	5
Oct. 14	Emmanuel Mejia	17
Oct. 15	Joshua Williams	13
Oct. 27	Marissa Espinoza	8
Oct. 30	McKenna Burns	5
Oct. 30	Collin Nielsen	4
Oct. 31	Luther Egerson	15

On All Saints' weekend, November 2-3, Emmaus members are invited to memorialize loved ones by purchasing one or more floral stems (one stem per person memorialized). We are asking \$5.00 per stem.

Number of flowers: _____ Payment included: \$ _____

My/Our name:

In memory of:

1.
2.
3.
4.
5.

Floral Arrangement Will Honor Our Saints

In the November *Visitor* and the All Saints' weekend worship bulletins, Emmaus will remember the saints from Emmaus who have joined the saints in heaven since All Saints' Sunday, 2012. Our list includes those who were members of Emmaus plus the non-members at whose funerals our pastors officiated.



ALL SAINTS' DAY

We would also like to mention those who were not members here but were important to you—family relations, dear friends, and loved ones. Please inform the church office (634-5515) by October 15 if you would like your loved one remembered.

You are invited to honor the memory of your loved ones by

purchasing a floral stem. All of these flowers will be placed together in an arrangement at the front of the church. Each stem will honor the memory of one person, and the names of all those honored will be placed in the bulletin.

These dedications need not be limited to the memory of those who have passed away within this year.

Please complete the above form and include \$5.00 for each person you are memorializing. The forms and donations may be placed in the offering plates or turned into the church office by October 15.

English Conversation Sessions Resume October 9

Volunteers are being sought to spend time from 6:00 to 7:30 p.m. Wednesday nights with adults who are working on their English skills. A willingness to be in conversation on a one-on-one or two-on-one basis is the only qualification needed.

Interested in learning more?

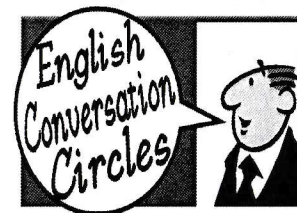

Contact Pastor Mary or one of the previous volunteers (Diane Melander, Kathy Christensen, Carol and Dennis Eschmann, Caren and Chris Lamberton, or Art Smith). Past experience has showed us that not only are language skills gained, but new friendships develop as a result of the conversation time.

Elevator Is Finally Up and Running

After a month out of service, the elevator is finally up and running again! An electronic circuit literally burned out in August, resulting in several frustrating attempts to replace it, and to reprogram the circuit board.



We may still need to look at a

major upgrade to the computerized hydraulic system that controls the elevator. Originally installed in 1987, its programming is out of date, and replacement parts are becoming impossible to come by. Think of any electronic equipment you have in your home, office or car that dates back to 1987 — if you have any at all — and imagine what it would take to repair it.

Kitchen Help Needed on Wednesdays

Help is needed in the kitchen Wednesday afternoon for the after school program supper. Please

contact the church office, Laura Bennett, or any of the EASY/SALT staff. Thank you!



RIC Celebrates Two Decades

Racine Interfaith Council (RIC)'s Public Meeting, October 17, at St. Richard Parish, 1509 Grand Avenue, Racine, at 7:00 - 8:30 p.m. RIC is celebrating



20 Years! This is their Big Event. Please mark your calendar for the next board meeting, October 10, 2013. It is very important that a representative from your congregation be present.

Emmaus Serves Community Meal October 3

The October 3 St. Patrick's Church Community Meal sign-up sheet is on a table in the narthex along with the casserole recipe; cake pans with lids are available in the plastic storage container under the table. Casserole recipes are again available on the table next to the sign-up sheet, or look it up on the Social Concerns page



of emmaus-racine.org. If you cannot help on October 3 but are available and could help serve food or clean up on another Thursday, feel free to drop in at St. Patrick's Church. You do not need to sign up.

NorthSide Food Pantry Volunteers

October 24 James Larrabee, Pat & Ron Jensen, Rich & Kathy Christensen
 November 28 Thanksgiving Day; no coverage planned
 December 26 Cindi and Loren Larsen, Cheryl Dexter, Dianne Melander

If you are unable to work your scheduled date, please trade with someone on the schedule. Also, please do not leave only two people on duty. Thank you for your support of this important ministry.

Staff to Attend Conferences

Emmaus staff members will attend two conferences during the month of October. Pastor Jhon Freddy and Pastor Mary will attend the Fall Theological Conference in Green Lake,

Wisconsin, September 30 and October 1. Pastor Mary and Nancy Smith will attend a conference for church leaders at the San Francisco Theological Seminary October 21-23.

Meet Andy and Kristin October 15 or 16

As a part of the FaithWorks grant request to the churchwide offices of the ELCA, a new staff position of youth and young adult outreach pastor has been proposed. Should the funding for such a position become a reality, an ordained person with gifts for developing and expanding youth and young adult ministry in Racine would be called.



While on vacation in August, Pastor Mary and Nancy Smith met an intern from Luther Seminary who has experience working with youth and who comes very highly recommended. They not only heard him preach, but they spent considerable time talking with him and his wife about Racine, FaithWorks, and the potential ministry among young people in our community.

After further conversation with Andy Twiton and with synod and FaithWorks leaders, it was decided to invite Andy and Kristin to Racine in October in order to

become better acquainted with our community and church leaders while pursuing the possibility of his being placed in the Greater Milwaukee Synod as a possible candidate for call.



Andy and Kristin will drive from St. Paul Tuesday, October 15, arriving in time for an informal "Meet and Greet" at 6:30 p.m. at the home of Pastor Mary and the Smiths (1530 South Main Street). FaithWorks leaders and all who are interested are invited.

To help for planning purposes, please call the church office (262-634-5515) or email mljanz@aol.com. Andy and Kristin will visit other FaithWorks congregations, the Synod office and the Racine area during their two-day stay.

A second opportunity to meet Andy and Kristin will be during the regular Wednesday night meal at Emmaus at 5:15 p.m. October 16.

October Birthdays: 70 Years and Better

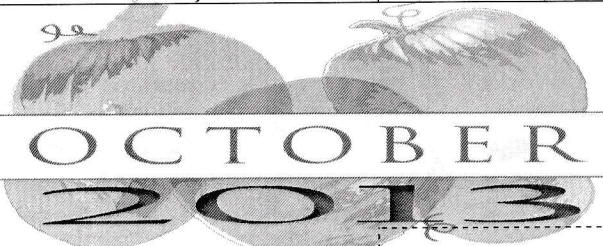
Oct. 4	Marge Jensen	1935 Jupiter Avenue	53404
Oct. 6	June Beck	733 West Lawn Avenue	53405
Oct. 10	Marlyn Christensen	4202 Walsh Road	53405
Oct. 19	Olav Thomsen	1233 Illinois Street	53405
Oct. 23	Marion Andersen	12895 W. Ohio Dr., New Berlin	53151
Oct. 30	Myrna Olesen	333 Lake Avenue # 608	53403

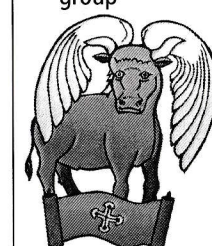
Sunday	Monday	Tuesday	Wednesday	Thursday	Friday	Saturday
 <p>OCTOBER 2013</p>		1 3:00 pm EASY 5:00 pm GED class 5:30 pm TOPS	2 3:00 pm EASY 5:00 pm Supper 6:00 pm Wed. God Time 7:00 pm FaithWorks Vision mtg., Atonement LC	3 11:00 am Bulletin deadline 3:00 pm EASY 4:00 pm BENNU legal appointments 6:00 pm Ensayo de coro 7:00 pm FaithWorks Mission council, LC of Redeemer	4 6:00 pm Support group	5 8:30 am Green congregations mtg., Holy Communion LC 5:00 pm Worship service with Holy Communion (English)
<i>Pastors at conference</i>						
6 20TH SUNDAY AFTER PENTECOST 9:15 am Season of Creation worship service: Storms; with Holy Communion (English) 10:30 am Coffee & conversation 10:30 am Blood pressure tests 12:00 m Santa misa (español) 12:30 pm Sunday School (bilingual)	7 10:00 am Knit 1, Purl 1; sewing group 3:00 pm EASY	8 3:00 pm EASY 5:00 pm GED class 5:30 pm TOPS 6:00 pm Worship planning mtg. at St. Andrew LC	9 1:30 pm Women's Bible study 3:00 pm EASY 5:00 pm Supper 6:00 pm Wed. God Time 6:30 pm English conversation	10 11:00 am Sunday bulletin deadline 3:00 pm EASY 6:00 pm Ensayo de coro 6:00 pm GED class 7:00 pm RIC board mtg.	11 6:00 pm Support group	12 COLUMBUS DAY 5:00 pm Worship service with Holy Communion (English)
<i>Pastor Mary off</i>						
13 21ST SUNDAY AFTER PENTECOST 9:15 am Worship service with Holy Communion (English) 10:30 am Coffee & fellowship 12:00 m Santa Misa (español) 12:30 pm Sunday School (bilingual) 1:00 pm CROP walk	14 COLUMBUS HOLIDAY 10:00 am Knit 1, Purl 1; sewing group 3:00 pm EASY 	15 Nov. Visitor articles due 3:00 pm EASY 5:00 pm GED class 5:30 pm TOPS 6:30 pm Meet & greet Andy and Kristin, 1530 S. Main St.	16 3:00 pm EASY 5:00 pm Supper 6:00 pm Wednesday God Time 6:30 pm English conversation	17 11:00 am Sunday bulletin deadline 12:00 noon Cluster clergy meeting 3:00 pm EASY 4:00 pm Wine tasting event 4:00 pm BENNU legal appointments 6:00 pm Ensayo de coro 6:00 pm GED class	18 ST. LUKE 6:00 pm Support group 	19 SWEETEST DAY 5:00 pm Worship service with Holy Communion (English)
20 22ND SUNDAY AFTER PENTECOST 8:30 am Musicians' rehearsal (English) 9:15 am Chicago Folk Service (English) 10:30 am Coffee & fellowship 12:00 m Santa misa (español) 12:30 pm Sunday School (bilingual) 1:00 pm Health care fair (español)	21 10:00 am Knit 1, Purl 1; sewing group 3:00 pm EASY	22 5:30 pm TOPS 6:00 pm GED class 6:30 pm Church council	23 3:00 pm EASY 5:00 pm Supper 6:00 pm Wed. God Time 6:30 pm English conversation	24 11:00 am Sunday bulletin deadline 3:00 pm EASY 6:00 pm Ensayo de coro 6:00 pm GED class	25 6:00 pm Support group	26 5:00 pm Worship service with Holy Communion (English)
<i>Pastor Mary out of town</i>						
27 REFORMATION SUNDAY TBA Worship service with Holy Communion (English) TBA Coffee & fellowship 12:00 m Santa Misa (español) 12:30 pm Sunday School (bilingual)	28 ST. SIMON & ST. JUDE 10:00 am Knit 1, Purl 1; sewing group 3:00 pm EASY	29 5:30 pm TOPS 6:00 pm GED class 7:00 pm Fireside Exchange	30 3:00 pm EASY 5:00 pm Trip to Johnson farm	31 REFORMATION DAY 11:00 am Bulletin deadline 3:00 pm EASY 4:00 pm BENNU legal appointments 6:00 pm Ensayo de coro 6:00 pm GED class	November 1 ALL SAINTS' DAY 6:00 pm Support group 7:00 pm Santa misa para Todos los Santos	2 8:30 pm Cool Congregations, LC of Resurrection 4:00 pm Worship service w/HC, at St. Andrew 2:00 am Daylight Saving Time ends

October Worship Leaders

	Altar Guild	Communion Assts.	Readers	Ushers
Sat. Sep. 28 5:00 pm	Amy & Marge Zielke, M. Porcaro	—	—	—
Sun. Sep. 29 9:15 am	Caren Lambertson	Karen Sedgwick Kathy Christensen	Jen Haman	Team 2 R. Christensen
Sat. Oct. 5 5:00 pm	Judy Berndt Linda Meteyard	—	—	—
Sun. Oct. 6 9:15 am	Grace Falaschi	Shirley Velzka	Melissa Lemke	Team 3
Sat. Oct. 12 5:00 pm	Brian & Denise Keller	—	—	—
Sun. Oct. 13 9:15 am	Barb Larsen Pat Jensen	Chris Lambertson Cindi Larsen	Lee Woodward	Team 1
Sat. Oct. 19 5:00 pm	Cathy Meyer Linda Clinton	—	—	—
Sun. Oct. 20 9:15 am	Bev Hansen Audrey Villalobos	Carol Eschmann	Nancy Smith	Team 5 Porcaro
Sat. Oct. 26 TBA	Barb & Jamie Toslek	—	—	—
Sun. Oct. 27 TBA	Kathy Christensen Marlyn Christensen	Nancy Smith Pat Jensen	Karen Sedgwick	Team 1
Sat. Nov. 2 TBA	Cheryl Dexter	—	—	—
Sun. Nov. 3 TBA	Joy Lippmann Marge Jensen	Kathy Christensen	Sandy Strini	Team 2 Christensen



Fellowship Hosts

October 6: Amy & Marge Zielke; Missy Porcaro

October 20: Loren & Cindi Larsen

Fall Back in November

Daylight Savings Time will end at 2:00 a.m. the morning of Sunday, November 3. You won't want to miss a minute of All Saints' Day, so do yourself a favor

and set your clocks back one hour before you go to bed on November 2.



Worship Is Highlight of FaithWorks Fall Festival

Despite a downpour Saturday afternoon and lower than expected attendance both afternoons, nothing was able to dampen the positive worship experience of the FaithWorks Fall Festival worship on Sunday, September 8.

St. Andrew Lutheran Church was the host of the event, joining in the planning with representatives of Emmaus and Emaús, Atonement East and West, Our Savior's, and Lutheran Church of the Redeemer.

Dennis Eschmann crafted a

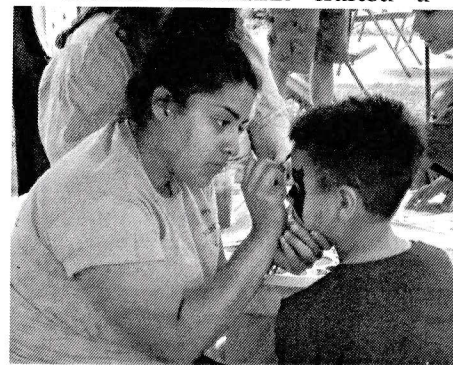

circular eight foot table comprised of puzzle pieces that were then painted by youth under the direction of Brenda Trumbauer. Each FaithWorks worshipping community had representatives carrying forward one of the puzzle pieces which made up the surface of the communion table. Worshipers were then invited to

sign their names on the table top, as we were reminded that everyone is welcome at the table.

The outdoor worship, with

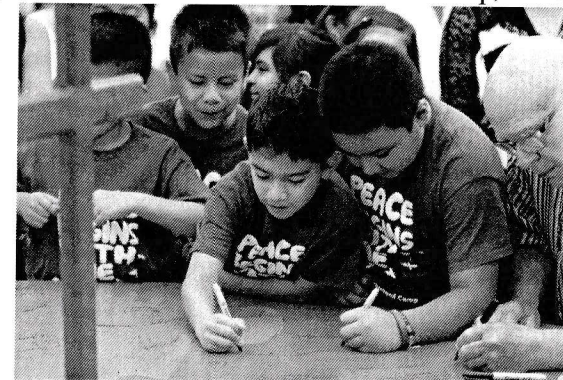

everyone sitting in a circle around the table, was filled with a spirit of unity amidst our diversity.

There were games, crafts, food, face painting, and vendor booths. Several people tried to see how long they could ride the mechanical bull. Various bands and singers entertained.

Special thanks go to Rich and Kathy Christensen, the Eschmanns, Art Smith for their special efforts, and to the many others who donated water, soda, baked goods, raffle items, time, and so much more. Overall proceeds from this year's festival totaled just under \$2,000, which is approximately \$10,000 less than last year. The FaithWorks Mission Council will spend time at their next meeting making a final evaluation and recommendations for future collaborative events.

Third Quarter Statements Are Available

Third quarter offering statements will be available by October 6. Statements for anyone who has made an offering of record and has been assigned an offering envelope number should be in the narthex. Please check that our records match yours. If you find any

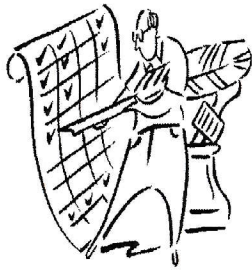

discrepancies, please let the office know.

Members should have received their October to January offering envelopes during the month of September. If you have not received your envelopes, we have unmarked sets available for the asking.

Joint Stewardship Committee Continues Work

Leaders from Emmaus and St. Andrew continue meeting as they make plans for this year's stewardship campaign, leading to Consecration Sunday, November 17. The next

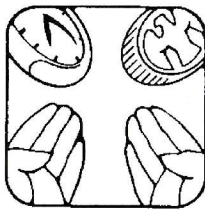

scheduled meeting is 7:00 p.m. October 14 with leader and guest preacher, Rev. Gary Liedtke, meeting the leadership team for the first time.

Crunching the Numbers

Weekly worship attendance averages (calculated as of Sept. 22, 2013)

	2011				2012			2013		
	Sat.	9:15	12:00	Wed.	Sat.	9:15	12:00	Sat.	9:15	12:00
Aug	21	49	119	n/a	9	39	158	14	40	136
Sep	17	65	194	83	11	43	206	11	54	121
Oct.	15	55	184	59	12	52	142			

Financial Figures

Total for month Year to date
 General Fund offerings received in Aug. '13: \$9,265.42 }
 + Adopted-bills: 121.56 } \$96,520.17

Mortgage retirement offerings received in Aug. '13.....	\$100.00.....	Campaign TD: \$73,152.62
Mortgage payments in Sept. '13:	Principal	867.26
	Interest.....	124.74
	Total.....	\$992.00
Principal balance as of September 13, 2013:	\$24,538.36	

WELCA to Meet in Charlotte

Women of the ELCA will gather in Charlotte, North Carolina July 24-27, 2014 for the Ninth Triennial Gathering under the theme "Of Many Generations." This will be a marvelous opportunity for grandmothers, mothers, daughters and granddaughters to share a rewarding experience.

In preparation for this event, Triennial Gathering Promoter Carole Ropel, has reserved a block

of ten (10) rooms at the Westin Hotel (adjacent to the Convention Center) for \$159 + tax per night.

"General Registration opens September 16, at which time you are able to book any of the five Triennial hotels at reduced rates or whatever you feel fits well. If you have questions please contact Carole Ropel: phone: 262-523-4130, e-mail: caroleropel@wi.rr.com

October Is Auxiliary Membership Month

For over half a century, the Lincoln Lutheran Auxiliary has lovingly provided those unbudgeted extras that make life more pleasant for the residents of Lincoln Lutheran facilities.

Through our membership dues, the Ice Cream Social and other fund raising projects, we've been able to provide items such as Christmas gifts, TV and sound equipment, computers, furnishings, wheelchairs, and parties. We've even purchased a

wheelchair accessible van.



Please help our residents by beginning or renewing your membership. You can also give a gift. Just fill out the bottom portion of this letter and mail it with your check made payable to the Lincoln Lutheran Auxiliary, to: Linda Cayemberg, 2620 5½ Mile Road, Racine, WI 53402-1657. Please include that Emmaus is your home church.

Lincoln Lutheran Auxiliary Membership Form 2010-11

(Please print)

Name (F/L).....
 Address.....
 City..... State..... ZIP.....
 Phone..... e-mail.....
 Date..... Church: Emmaus Ev. Lutheran Church
 Membership type: Annual (\$5.00) Annual Plus (\$15.00)
 Lifetime (\$150.00) Additional donation:

How Can We Prevent Bee Colony Collapse?

By John Berge

One out of every three bites of food you eat is dependent upon bees for pollination and production ... even more if you are a vegetarian. Up to 80% of the flowers we enjoy in our gardens or in the wild rely upon bees and other pollinators to reproduce. The honey bee, even though it is an imported insect, is a very important part of our agriculture, horticulture and our very lives. It may be "alien," but it is not "invasive" like so many other imported insects.

The honey bee has been having a very hard time lately with die-offs in the hives, on farms (37 million on a single farm in Ontario, Canada) and even in parking lots (50,000 in one event in Oregon). Last winter, bee keepers reported losses of 40 to 90 percent of their bees in what has been termed Colony Collapse Disorder.

What can we do to protect this essential part of our environment? First of all we can plant flowers as supplies of nectar and pollen to support these bees, and second we can minimize the use of pesticides, especially ones that are fatal or injurious to bees. Recent scientific studies point to neonicotinoids, a class of the most popular pesticides, as a key contributing cause to the losses.

The European Union has banned the use and sale of these pesticides.

It has also become evident that some of the largest "big box" stores in this country are treating their plants and seeds with these neonicotinoids and selling the flowers and seeds as "bee friendly." Friends of the Earth, from whom the information above has been taken, has started a petition campaign to have neonicotinoids removed from the shelves of at least two of these chains.



In a somewhat different but related area — all the environment is really attached to everything else —

Wisconsin Interfaith Power and Light is putting on a three-hour training workshop on Cool Congregations in which, "People of faith across Wisconsin are caring for the earth by reducing the causes of climate change in their own homes and saving money in the process." The training event will take place at Resurrection Lutheran Church, 322 Ohio Street, on November 2, 9:00 a.m. to noon. That may seem a long way off, but registration is required by October 25 at: www.wisconsinipl.org/coolcongregations. The cost is \$15 /person or \$30/congregation team of two or more.

St. Andrew Lutheran Church Plans Craft Fair

Date: October 26, 2013. Time: 9:00 a.m. to 3:00 p.m. Location: St. Andrew Lutheran Church, 1015 Four Mile Rd., Racine, WI 53402.

Food will be available for purchase during event. All proceeds belong to the seller.

Auxiliary Holds Used Book Sale

The Lincoln Lutheran Fall Book Sale is Tuesday and Wednesday, October 15 and 16. As usual, the sale will be at Lincoln Lutheran Village, on Highway 31 across from Mt. Pleasant Lutheran Church; the parking is right in front of the main entrance and the sale is right through the main doors.



Lincoln Lutheran Auxiliary to provide "wishes" for the various Lincoln Lutheran facilities — those things that provide extra comfort and pleasure for the residents, but which budgets just can't cover. Books make wonderful gifts for others or ourselves, so buying at the book sale is a win-win situation.

All proceeds are used by the

Sunday Morning Church Is Not For Everyone

You probably know them: the family for whom worship has become next to impossible. They have a child with autism, a spouse with Alzheimer's, someone with severe hearing loss. Perhaps it's a person who feels self-conscious about their oxygen tank. Whether we like it or not, these folks often feel like they are on the outside looking in. Please let them know about a new opportunity for them: Gentle Worship. Beginning October 6, there will be a worship service for families with individuals who are

challenged by special needs or otherwise "on the edge." The casual, 30 minute service starts at 4:00 p.m., and features familiar songs as well as Holy Communion.

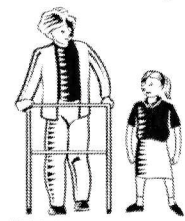

Gentle Worship takes place at the Northwest Campus of Holy Communion Lutheran Church, 5040 Northwestern Ave. (Highway 38, just west of Highway 31). If you have any questions, you can contact Pastor Walter Hermanns at pastorwalter@yahoo.com.

A New Creation

Following the unanimous vote at the Emmaus congregational meeting, approving shared worship with St. Andrew, I was more than eager to find out what had happened at the congregational meeting held at our sister congregation. They had met the same morning. They had considered the same question of shared worship we had. When Pastor Michael didn't answer his phone immediately, I got in my car and headed directly for St. Andrew.

The first person I encountered was St. Andrew council president, Pam Robers, who greeted me with a "thumbs up!" I later talked with Pastor Michael Mueller, and Pastors David Rhoads and Sandy Roberts, both members of St. Andrew. The tone of the conversations was positive and hopeful.

As we were all about to leave, I shared with Dr. Rhoads that one of our members had asked the question, "What will we call ourselves? Where will I tell people that I worship?" There was no answer to that question as we talked in the parking lot that Sunday. In fact, Dave announced that there was an "emergency" and

they had to get going! (The Packers game had already begun, and he was antsy to get home and watch it!)

However, that question about name and identity stayed with Dave well beyond the Packers game that afternoon. In fact, the next day Pastor Michael and I received an e-mail from him that included the following thoughts:

"I wonder if we could consider a new name and an appropriate one might be 'New Creation Lutheran Church'?

"This would be deeply biblical: 'When anyone is in Christ, creation is new. The old has passed away. Behold! Everything is

new!' II Corinthians 5:17

"It would depict the new creation that has come out of our combined congregations.

"And it would reflect our common commitment to serving God in bringing about a new creation on Earth.

"And it would be unique and distinctive among Lutheran churches in focusing on the first article of the creed."

We're not there yet, but there has been considerable movement

➔ Please turn to page 19

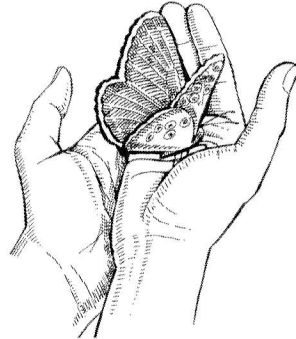

➔ Continued from page 18

toward something new. As some of us now refer to ourselves as "FaithWorks North—Emmaus and St. Andrew campuses," let us never underestimate the power of God to create and to re-create and to make all things new. I can't wait to see where the Spirit leads us next! Are we ready to grow into such a bold name as "New

Creation Lutheran Church?" Never forget that in God, all things are possible!

Grateful to be part of an ever Re-forming church,

Pastor Mary
Pastor Mary

Quartet Performs at Our Savior's

New Creations Ministry welcomes Ministers Quartet in concert at Our Savior's Lutheran Church, 2219 Washington Ave., Racine, Wisconsin 53405, Sunday,

October 20 at 9:45 a.m. A love offering will be taken. Call 262 633-2243 or 262-658-8412, or go to www.newcreationsministry.com

RESPONDING TO U.S. FLOODING

LUTHERAN DISASTER RESPONSE ALERT

Sept. 2013

Gifts designated to "U.S. Flood Relief" through Lutheran Disaster Response will be used entirely — 100 percent — to help survivors of floods rebuild their lives and livelihoods. Our church is reaching out in response to these devastating storms and assessing the needs — working together for as long as it takes. Thank you for your gifts, your prayers and your partnership.



Yes, I want to help!

- Lutheran Disaster Response: *U.S. Flood Relief* \$ _____ DDF0069
 Lutheran Disaster Response: *Where Needed Most* \$ _____ DDF0010

Name _____

Address _____

City _____ State _____ ZIP code _____

Email Address _____

Give through your congregation or send your check directly to:
Lutheran Disaster Response, P39330 Treasury Center, Chicago, IL 60694-9300
 Write "U.S. Flood Relief" or "Where Needed Most" on your check's memo line.



Evangelical Lutheran Church in America
 God's work. Our hands.

Lurking in the October Visitor:

- ✿ Wine Tasting Party
- ✿ Sewing, Knitting
Groups Resume
- ✿ Trip to Johnson Farm
- ✿ All Saints Flowers
- ✿ Elevator Update
- ✿ RIC Celebrates 20
Years
- ✿ Meet Andy & Kristin
- ✿ Fall Festival Report
- ✿ Joint Stewardship Work
- ✿ A New Creation

...and plenty more

Emmaus Evangelical Lutheran Church
1925 Summit Avenue
Racine, Wisconsin 53404-2374

Change service requested

Non-Profit Org.
U.S. Postage PAID
Racine, WI
Permit No. 137



Emmaus Visitor

November, 2013

Emmaus to Host Thanksgiving Eve Service November 27

The joint Emmaus-St. Andrew Thanksgiving Eve service will be on Wednesday, Nov. 27 at 7:00 p.m. at Emmaus. The service will include celebration of Holy Communion.

As part of our Thanksgiving Eve service, there will be a processional offering of non-perishable food items to be used for the Northside Food Pantry.

If you prefer to give a monetary contribution to the Northside Food Pantry located at Trinity United Methodist, make your check payable to Emmaus and indicate "Food Pantry" on the memo line or on the upper right blanks of your offering envelope. Thank you for your generosity!

After the service, join the fellow members of your Emmaus and St. Andrew families for the pie social in Fellowship Hall. Donations at the tables will be

Worship Schedule

Saturday 4:30 pm
Sunday 9:00 am

Date	Location	Theme
Oct 26-27	St. Andrew	Reformation
Nov 2-3	Emmaus	All Saints
Nov 9-10	Emmaus	Chicago Folk
Nov 16-17	Emmaus	Consecration Sunday
Nov 23-24	Emmaus	Christ the King
Nov 27	Emmaus	Thanksgiving Eve 7:00 pm
Nov 30 - Dec 1	St. Andrew	Advent
Dec 7-8	St. Andrew	Chicago Folk Advent
Dec 14	St. Andrew	Advent
Dec 15	St. Andrew	Christmas Pageant
Dec 21-22	St. Andrew	Advent
Dec 24	St. Andrew	Christmas Eve 4:30 pm
Dec 28-29	St. Andrew	Carol Sing

used to finance the youth of our congregations.

Emmaus Evangelical Lutheran Church
"Sent Forth by God's Blessing"
e-mail: emmausracine@sbcglobal.net
www.emmausracine.wordpress.com

1925 Summit Avenue
Racine, Wisconsin 53404
Phone: 262 634-5515
Fax 262 634-0835

We Remember Our Loved Ones on All Saints' Sunday



ALL SAINTS' DAY

During All Saints' Day worship on November 2 and 3, we pause to honor the saints from Emmaus who have joined the saints in heaven during the past year. These are our members who have died and others at whose funerals our pastors have presided since last All Saints' Day:

Juan Ortiz Vallin	June 12, 1931 – Nov. 15, 2012
Jose Cruz	Nov. 14, 1932 – Nov. 29, 2012
Isabelle Traeger Barry	Aug. 8, 1914 – Dec. 13, 2012
Jesus Vargas Rodriguez	Sept. 2, 1973 – Dec. 28, 2012
Amiyah Medina	Jan. 21, 2013 – Jan. 21, 2013
Patricia A. Sorensen Devine	Apr. 29, 1939 – Jan. 25, 2013
Martin C. Andersen	May 2, 1928 – Feb. 25, 2013
Alfred Beck	Aug. 12, 1920 – Mar. 30, 2013
Silverio Gutiérrez Alarcón	Aug. 24, 1927 – Apr. 1, 2013
Ella Marie Christiansen Nielsen	Sept. 27, 1923 – Apr. 24, 2013
Harris P. Larsen	Apr. 5, 1919 – July 11, 2013
June Elaine Matson Clark	June 29, 2013 – Aug. 18, 2013
Marcella Ruth Sorensen Runge	June 1, 1916 – Sept. 8, 2013
Jeffrey A. Lanser	June 20, 1959 – Sept. 17, 2013

A floral display commemorating these and other persons dear to our members will decorate the front of the church.

Pastoral Acts

<p>Weddings: Sandra Yanez Todd Gibson October 5, 2013</p>	<p>Pastor Mary presided over Todd and Sandra's wedding at Atonement Lutheran Church. Todd is a brother-in-law of Cathy Meyer.</p>
<p>Memorial Service: Jeffrey A. Lanser October 19, 2013</p>	<p>Pastor Mary led a memorial service for retired Air Force Master Sergeant Jeff Lanser, 54, a nephew of Evelyn Larsen. A 1977 graduate of Park High School, he was active at First Baptist Church of Minot. His survivors include four married children and twelve grandchildren.</p>

Consecration Sunday Is Coming

Congregations that approach financial stewardship from a biblical perspective do not view the money Christians give to their church merely as a way to pay its bills. Rather, such congregations see financial contributions as a way to help people grow spiritually in their relationship with God by supporting their church's mission and ministry with a percentage of their incomes.

Our congregation's council has selected the New Consecration Sunday Stewardship Program as a way to teach the biblical and spiritual principles of generous giving in our stewardship education emphasis this year.

New Consecration Sunday is based on the biblical philosophy of the need of the giver to give for his or her own spiritual development, rather than on the need of the church to receive. Instead of treating people like members of a social club who should pay dues, we will treat people like followers of Jesus Christ who want to give unselfishly as an act of discipleship. New Consecration Sunday encourages people toward proportionate and systematic giving in response to the question,

"What percentage of my income is God calling me to give?"

During morning worship on Consecration Sunday, we are asking our attendees and members to make their financial commitments to our church's missionary, benevolent, and educational ministries in this community and around the world.

Every attendee and member who completes an Estimate of Giving Card does so voluntarily by attending morning worship on Consecration Sunday. We urge people to attend who feel strongly opposed to

completing a card. The procedure is done in such a way that no one feels personal embarrassment if he or she chooses not to fill out a card.

We will do no home solicitation to ask people to complete cards. During morning worship our guest leader will conduct a brief period of instruction and inspiration, climaxed by members making their commitments as a confidential act of worship.

We will encourage participation in Consecration Sunday events through the Consecration Sunday team and

➔ Please turn to page 12

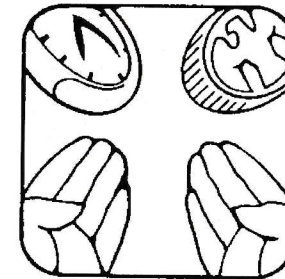

'We Walk Because They Walk'

58 Emmaus members and youth from our after school programs, EASY and SALT, joined in Racine's CROP Walk against hunger on October 13.

The CROP Hunger Walk is sponsored by Church World Service. Half of all funds raised by Racine walkers go to help local food pantries, while the other half is used by CWS to combat hunger nationwide.



Emmaus Staff & Worship Times

Pastors: Rev. Mary L. Janz Mljanz@aol.com 262/633-3059
 Rev. Jhon Freddy Correa jhoncorrea@hotmail.com 414/881-1403
Council President: Chris Lambertson clamberton@wi.rr.com
Church office: Paul Berge emmausracine@sbcglobal.net
Education Coord.: Nancy Smith nnsdaisy@aol.com
Director Outreach: Liliana Moncada liliana.moncada@hotmail.com
Accompanist: Brenda Trumbauer brenda6175@gmail.com
Custodians: Rich Benson & Antelmo Hernandez

English language services are held at Emmaus every Saturday evening at 4:30 and Sundays at 9:00 a.m. during odd-numbered months, and at St. Andrew during even-numbered months. Spanish language services are offered Sundays at noon, and Friday, November 1 at 6:00 p.m. Thanksgiving Eve services will be at 7:00 p.m. Wednesday, November 27 at Emmaus.

Emmaus office hours are 9:00 a.m. to 3:00 p.m. Monday through Friday (closed on Thanksgiving).

The VISITOR is published monthly September to July. The deadline for the December VISITOR is November 15. Submit articles to Paul Berge's attention by mail or by e-mail.

Emmaus Visitor Vol. 42, No. 3 November, 2013

Johnsons Host Hay Ride October 30

Kids of Emmaus have been invited by Gordie, Danny and Kris Johnson to have some pre-Halloween fun at their farm. This excursion will take the place of our regular Wednesday night meal



and God Time for kids on October 30. Adults willing to provide rides to the kids, leaving the church at 5:00 p.m., should contact the church office or Nancy Smith.

EASY Kids Ask, 'Will It Float?'

Using their hands and heads, the EASY kids recently explored Engineering 101. They were given straws, cups, plastic wrap, duct tape and 25 pennies and told to create a floating craft that would support the pennies. Shrieks of "Yes!" and "Oh, no!" could be heard as they succeeded or watched their creation sink. The end result: they got to understand a bit about the science of

buoyancy.

With Halloween just around the corner, hands were busy creating everyone's favorite: slime. It is fun to have a bag of a polymer like substance to stretch and pull and watch it become a long snakelike creation as it slowly stretches to the floor.

Youth Birthdays

Nov. 2 Valeria Salinas Diaz, 16
 Nov. 4 Gaby Gallegos, 16
 Nov. 8 Gabby Ludwig, 16
 Nov. 11 Dulce Blancarte, 2
 Nov. 11 Jocelyn García, 2
 Nov. 16 Azucena Delarosa, 9
 Nov. 18 Alberto Maldonado Jr., 12
 Nov. 23 Rachael Cox, 10
 Nov. 30 Tavijon Yust, 10



Are After School Activities Still On?

After school activities, such as Emmaus After School for Youth (EASY), the Wednesday supper, and Wednesday God Time will be



canceled whenever weather conditions close Racine Unified Schools.

There will be no classes Thanksgiving Eve in order to have an opportunity to worship together that evening.

Auxiliary Boxed Chocolates Are For Sale

by Cathy Meyer

Lincoln Lutheran Auxiliary candy is once again available for purchase after worship services at the Scrip table. Each box of the mint chocolate or caramel chocolate candy costs \$2.00, and the assorted candy bars cost \$1.00 each. The Auxiliary uses proceeds toward purchase of items to

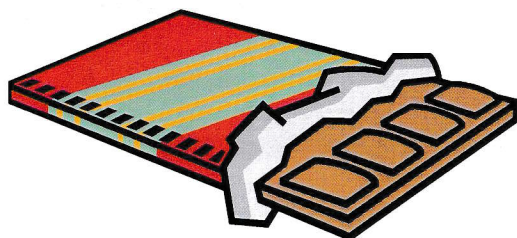

brighten the lives of Lincoln Lutheran residents. Contact Cathy Meyer if you have any questions.

Care for Creation; Save Money

Cool Congregations of Racine, a program of Wisconsin Interfaith Power and Light, is offering a Training Event on Saturday, November 2 from 9:00 a.m. to noon at Lutheran Church of the Resurrection, 322 Ohio Street, to help us learn how to continue caring for creation.



The workshop is designed to help households reduce their carbon footprint resulting in helping the earth and also saving you money. We must register ahead of time so please contact Sandy Strini (639-3755) as soon as possible. Your household will be tracking their energy use and hopefully be able to share a success story in a few months.

November Worship Leaders

	Altar Guild	Communion Assts.	Readers	Ushers
Sat. Nov. 2 4:30 pm	Cheryl Dexter	—	—	—
Sun. Nov. 3 9:00 am CST	Joy Lippmann Marge Jensen	Kathy Christensen	Sandy Strini	Team 2 Christensen
Sat. Nov. 9 4:30 pm	Marge & Amy Zielke, M. Porcaro	—	—	—
Sun. Nov. 10 9:00 am	Caren Lamberton	Diane Melander Joy Lippmann	Carol Eschmann	Team 4 Meteyard
Sat. Nov. 16 4:30 pm	Judy Berndt Linda Meteyard	—	—	—
Sun. Nov. 17 9:00 am	Grace Falaschi	Karen Sedgwick	Chris Lamberton	Team 3
Sat. Nov. 23 4:30 pm	Cathy Meyer Linda Clinton	—	—	—
Sun. Nov. 24 9:00 am	Barb Larsen Pat Jensen	Chris Lamberton Cindi Larsen	John Knuteson	Team 5 Porcaro
Wed. Nov. 27 7:00 pm	Pat Jensen	—	—	Team 1

December worship services at St. Andrew

Sat. Nov. 30 4:30 pm	Brian & Denise Keller	—	—	—
Sun. Dec. 1 9:00 am	Bev Hansen Audrey Villalobos	Shirley Velzka	Jim Larrabee	Team 2 Christensen

Fellowship Hosts

Nov. 3: Pat Jensen & Co.

Nov. 10, 17, 24: Please sign up on the sheet on the Sunset Room door

November Bible Readings

Nov. 3: Daniel 7:1-3, 15-18; Psalm 149; Ephesians 1:11-23; Luke 6:20-31





Nov. 10: Job 19:23-27a; Psalm 17:1-9; 2 Thessalonians 2:1-5, 13-17; Luke 20:27-38

Nov. 17: Malachi 4:1-2a; Psalm 98; 2 Thessalonians 3:6-13; Luke 21:5-19

Nov. 24: Jeremiah 23:1-6; Psalm 46; Colossians 1:11-20; Luke 23:33-43

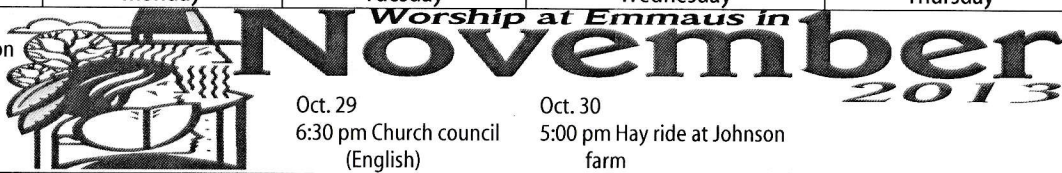
Nov. 27: Deuteronomy 26:1-11; Psalm 100; Philippians 4:4-9; John 6:25-35

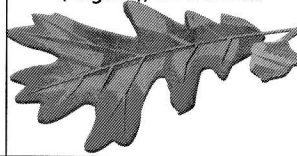
Dec. 1: Isaiah 2:1-5; Psalm 122; Romans 13:11-14; Matthew 24:36-44

Sunday	Monday	Tuesday	Wednesday	Thursday		
Oct. 27 REFORMATION SUNDAY 9:00 am Worship service w/Holy Communion at St. Andrew (English) 12:00 d Santa misa (español)					1 ALL SAINTS' DAY 6:00 pm Support group 6:00 pm Santa misa (español)	2 8:30 am Cool Congregat'ns at LC Resurrection 4:30 pm Worship service with H.C. (English), at Emmaus
3 ALL SAINTS' SUNDAY 2:00 am <i>Daylight Savings Time ends</i> 9:00 am CST Worship service with Holy Communion (English), at Emmaus 10:10 am Coffee & fellowship 12:00 d Santa misa (español) 12:30 pm Sunday School (bilingual)	4 10:00 am Knit One Purl One; sewing group 3:00 pm EASY 6:00 pm Coach group (español)	5 3:00 pm EASY 5:00 pm TOPS 6:00 pm GED class 	6 3:00 pm EASY 5:00 pm Supper 6:00 pm God Time 6:00 pm English conversation circles	7 11:00 am Sunday bulletin deadline 3:00 pm EASY 6:00 pm Ensayo de coro 6:00 pm GED class 7:00 pm FaithWorks at Atonement	8 6:00 pm Support group 6:00 pm Confirmaciones 6:00 pm High school youth	9 10:00 am Clase de 1ª comunión 4:30 pm Worship service with Holy Communion (English), at Emmaus
<i>Pastor Mary's week off</i>						
10 25 TH SUNDAY AFTER PENTECOST. MARTIN LUTHER BORN, 1483 9:00 am Chicago Folk service with Holy Communion (English), at Emmaus 10:10 am Coffee & fellowship 12:00 d Santa misa (español) 12:30 pm Sunday School (bilingual) TBA pm Stewardship leaders meeting	11 VETERANS' DAY 10:00 am Knit One Purl One; sewing group 3:00 pm EASY 6:00 pm Coach group (español)	12 12:00 n Cluster clergy mtg., Atonem't 5:00 pm TOPS 6:00 pm GED class 6:00 pm Church council (español)	13 1:30 pm Lydia Circle 6:00 pm EASY 5:00 pm Supper 6:00 pm God Time 6:00 pm English conversation circles	14 11:00 am Sunday bulletin deadline 3:00 pm EASY 4:00 pm BENNU legal appointments 6:00 pm Ensayo de coro 6:00 pm GED class	15 December newsletter articles due 6:00 pm Support group	16 4:30 pm Worship service with Holy Communion (English), at Emmaus 
17 26 TH SUNDAY AFTER PENTECOST 9:00 am Consecration Sunday worship service w/Holy Communion (English), at Emmaus 10:30 am Stewardship brunch 12:00 d Santa misa (español) 12:30 pm Sunday School (bilingual)	18 10:00 am Knit One Purl One; sewing group 3:00 pm EASY 6:00 pm Coach group (español)	19 3:00 pm EASY 5:00 pm TOPS 6:00 pm GED class 6:30 pm Church council (English)	20 3:00 pm EASY 5:00 pm Supper 6:00 pm God Time 6:00 pm English conversation circles	21 11:00 am Sunday bulletin deadline 3:00 pm EASY 6:00 pm Ensayo de coro 6:00 pm GED class	22 6:00 pm Support group 6:00 pm High school youth	23 4:30 pm Worship service with Holy Communion (English), at Emmaus
24 CHRIST THE KING SUNDAY 9:00 am Worship service with Holy Communion (English), at Emmaus 10:10 am Coffee & fellowship 12:00 d Santa misa (español) 12:30 pm Sunday School (bilingual)	25 <i>No EASY this week</i> 10:00 am Knit One, Purl One 6:00 pm Coach group (español)	26 5:00 pm TOPS 6:00 pm GED class 7:00 pm Fireside Exchange	27 9:00 am Bulletin deadline 7:00 pm Worship service with Holy Communion (bilingual) 8:00 pm Pie social	28 THANKSGIVING <i>Office closed</i> 10:00 am Meal at Festival Hall	29 6:00 pm Support group	30 ST. ANDREW 4:30 pm Worship service at St. Andrew (English) 
Dec. 1 FIRST SUN. IN ADVENT. WORLD AIDS DAY 9:00 am Worship with Holy Communion at St. Andrew LC (English) 10:10 am Coffee & fellowship 12:00 m Santa misa (español) 12:30 pm Sunday School (bilingual)	2 10:00 am Knit One Purl One; sewing group 3:00 pm EASY 6:00 pm Coach group (español)	3 ST. THOMAS 3:00 pm EASY 5:00 pm TOPS	4 3:00 EASY 5:00 pm Supper 6:00 pm God Time 6:00 pm English conversation circles	5 11:00 am Sunday bulletin deadline 3:00 pm EASY 5:00 pm Community Meal at St. Pat's	6 ST. NICHOLAS 6:00 pm Support group 6:00 pm Confirmaciones 6:00 pm High school youth	6 10:00 am Clase de 1a comunión 4:30 pm Worship service with Holy Communion, at St. Andrew (English)

Please Remember Kellers in Your Prayers

Brian Keller's father, Henry, passed away on October 2. Henry

Keller was a member of Gethsemane Lutheran Church.

November Birthdays: 70 Years and Better

Nov. 11	Boots LeRoux	3418 Saint Clair Street, Racine	53402
Nov. 16	Janice Nielsen	1206 Fairway Drive, Racine	53406
Nov. 26	Judy Berndt	1525 Howard Street, Racine	53404

Wine Tasting Party Enjoyed by All

50 Emmaus members and friends attended the wine tasting fundraiser, held at the Wind Meadows Leisure Center on November 17. Organized by Carolyn Wooster, the party was filled with laughter, conversation, a sampling of wines, microbrews and appetizers, together with music provided by Dan Garnett, the Traveling Musician.

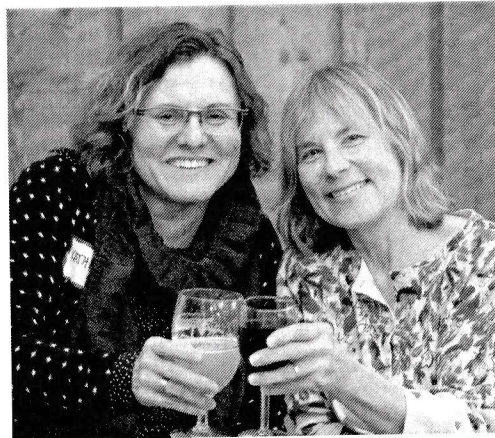

Over a dozen raffle baskets and a 50/50 raffle topped off the evening. Although the final accounting is not in at press time, an estimated \$1,600 was raised, which includes matching funds

from Thrivent Financial for Lutherans.

Thanks to all who made the evening a big success!

Here's That Time If Only You Had

When you set your clock back at the end of Daylight Saving Time on the night of November 2, you can use that extra hour to start the exercise regimen or fix



that leaky faucet or clean out the garage or write those letters you have been meaning to do something about if only you had the time.

Or you could just grab an extra hour of sleep like most people do.

Scrip Cards Benefit Emmaus

Scrip gift cards continue to be sold after church services. Start thinking ahead to holiday gift giving and let Cathy Meyer or Chris Lamberton know which cards



you may need. A complete list of participating retailers is available and special orders can be received by the following weekend. By supporting the Scrip program, you are contributing to the general fund of Emmaus.

NorthSide Food Pantry Schedule

November 27: Thanksgiving Day. We will not be covering Thanksgiving unless you hear differently from Cindi Larsen.

December 27: Cindi and Loren Larsen, Cheryl Dexter, Dianne Melander

On All Saints' weekend, November 2-3, FaithWorks-North members are invited to memorialize loved ones by purchasing one or more floral stems (one stem per person memorialized). We are asking \$5.00 per stem.

Worship services will be at Emmaus: 4:30 p.m. Saturday and 9:00 a.m. Sunday.

Number of flowers: _____ Payment included: \$ _____

My/Our name:

In memory of:

1.
2.
3.
4.
5.

Please turn this form in to the church office or through the offering plate by Monday, October 28. Thank you!

Redeemer Withdraws from FaithWorks

FaithWorks leadership has been informed by the Redeemer church council that Lutheran Church of the Redeemer has prayerfully considered their relationship with FaithWorks and has decided that they not continue in the direction of the profound partnership of FaithWorks.



While they do desire to work together in ministering to the Racine community, they do not see themselves as a part of the unions that are forming (i.e., Emmaus and St. Andrew, and Our Savior's and Atonement). We continue to hold one another in prayer as we all seek to respond to God's call to reach out in mission in Racine and beyond.

Consecration Sunday

→ Continued from page 3

council members. Since we will make no follow-up visits to ask people to complete their cards, we will make every effort to inform, inspire, and commit everyone to attend Consecration Sunday

worship.

Thanks in advance for your enthusiastic participation in Consecration Sunday events.

— Council President, Chris Lamberton.

Crunching the Numbers

Weekly worship attendance averages (calculated as of Oct. 20, 2013)

	2011				2012			2013		
	Sat	Sun	dom	Wed	Sat	Sun	dom	Sat	Sun	dom
Aug	21	49	119	n/a	9	39	158	17	40	136
Sep	17	65	194	83	11	43	199	12	49	139
Oct	10	64	149	73	12	52	142	14	37	190
Nov	14	65	210	81	21	51	201			

Financial Figures

General Fund offerings received in Sep. '13: Total for month \$10,828.23 Year to date \$106,534.14

Mortgage retirement offerings received in Sept. '13 \$150.00 Campaign TD: \$73,302.62

Mortgage payments in Sept. '13: Principal \$ 867.26

Interest..... \$ 124.74

Total..... \$992.00

Principal balance as of October 14, 2013: \$23,671.10



Attendance and Offering Report

Elsewhere In Our Area

Thrivent Election Slated

All Thrivent Financial members are invited to the annual Racine Chapter election on Saturday morning, November 16 at Infusino's Banquet Hall, 3201 Rapids Drive. Registration begins at 8:30 a.m. and breakfast will be served at 9:00. Breakfast is free, but please bring 2-3 items for local food pantries. RSVP to Terri Tigges at ttigges@racinelutheran.org or 262 884-9338 by November 11.

offering radical hospitality to persons who often feel uncomfortable or excluded in traditional worship settings.

The next gathering for Gentle Worship will be Saturday November 2 at 4:00 p.m. at Holy Communion Lutheran Church Northwestern Campus, 5040 Northwestern Avenue.

Gentle Worship Starts Yoga Class

The Gentle community invites everyone interested in a safe and easy approach to better health and well-being through yoga! A certified yoga instructor, Jana

Worship

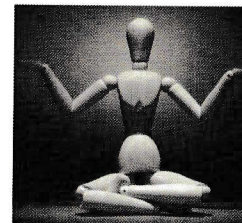

Gasiorkiewicz, who has special training in yoga for people with disabilities, will offer classes beginning Monday, October 28 at 5:30 p.m. The cost is only \$40.00 for 10 weeks or \$5.00 per session. For further information, please look on the Gentle Worship Racine Facebook page or call Holy Communion Lutheran Church, 262-632-8802. Gentle Worship is a ministry of Holy Communion,

Carthage Announces Christmas Concerts

Carthage College invites the community to celebrate the joy of the holiday season at the annual Carthage Christmas Festival, three performances of readings and music in the A. F. Siebert Chapel. These annual concerts are the College's Christmas gift to the community. Tickets to the Christmas Festival have been free since the festival began 24 years ago.

Concert Times: 7:30 p.m. Friday, Dec. 6; 7:30 p.m. Saturday, Dec. 7; 4:00 p.m. Sunday, Dec. 8.

For information and reservations, call the Chapel Office at 262-551-5810 between 8:00 a.m. and 4:00 p.m. Monday-Friday. Please note: the Chapel Office is closed Nov. 28-29. You can also send an email to ChristmasFestival@carthage.edu

Watch for Thanksgiving Dinner Details

"Dan and Ray Rendering Thanks" plan to give away their free Thanksgiving Day meal at Racine's Festival Hall



to 4:00 p.m. You can also help by sponsoring a person for \$5.00 or a table for \$50.00. Your name, or that of your company or organization, will be displayed on a table tent or place mat upon request. Please call 262 554-5440.

We will post updates at www.emmausracine.wordpress.com

Lydia Circle Meets

The women's Bible study group will meet at Emmaus Wednesday, November 13 at 1:30. Pastor Mary will lead a discussion of Sunday's Bible readings.

again this year. Complete details were not available as the *Visitor* went to press; in past years, the meal was served from 10:00 a.m. to 2:00.

They are looking for volunteers to donate time, services or help on Wednesday, November 27 from 5:00 p.m. and on Thanksgiving Day from 7:00 a.m.

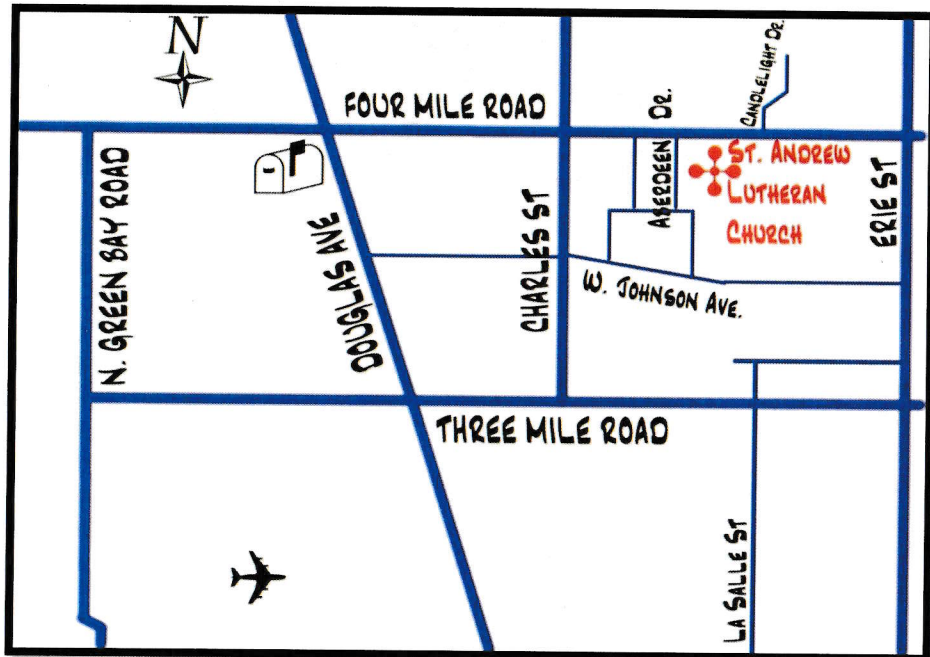

Pastor Mary's Column

Traveling to Unknown Territory

I write this on the eve of boarding a flight to San Francisco, a city which I have never before visited. Registering for the UNCO conference was something done without knowing exactly what to expect. Oh, I do know it is being held at San Francisco Theological Seminary. I do know it is referred to as the "Unconference" because there are no high power keynote speakers on the docket. I also know that this "unconference" for clergy and religious leaders is meant to spark collegiality and creativity. I've also recently learned that the word "unco" appears in the dictionary! It means "something extraordinary, remarkable or unusual."

I signed up for UNCO before I knew that Emmaus and St. Andrew would be worshipping together the weekend I returned, and that I would be leading that worship. That will be even more untraveled territory! I definitely need a guide in this journey, and I

am trusting in God's Spirit to lead. It is a relief to know that our Guide moves ahead of us, making the path passable and possible.

In San Francisco, they have suggested that we bring a flashlight for the very dark nights. After I get home, I know we will have to depend on an even brighter light, the Light of the World to lead the way. This is territory worth exploring!

I hope you will join me as a traveling companion in the next steps of what is already an extraordinary and remarkable journey together. See you in worship at St. Andrew (4:30 Saturday or 9:00 Sunday) Reformation weekend—October 26 and 27! And, don't forget—the following weekend we return to Emmaus for the month of November.

See you in church!

Pastor Mary
Pastor Mary

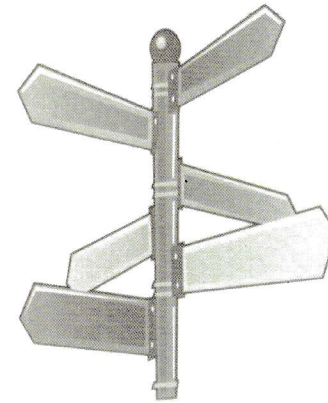

Memorials & Honoraria

Memorial Fund



Non-designated memorials:

In memory of Marcella Runge: \$500.00

In the November Visitor:

- ☛ Thanksgiving Day
Services at Emmaus
- ☛ All Saints' Sunday
- ☛ Consecration Sunday
Is November 17
- ☛ CROP Walk Report
- ☛ Hay Ride October 30
- ☛ Auxiliary Chocolates
- ☛ Wine Tasting Party
- ☛ Scrip Cards for Sale
- ☛ FaithWorks Update
- ☛ Thanksgiving Day
Meal at Festival Hall
- ☛ Traveling to Unknown
Territory

Emmaus Evangelical Lutheran Church
1925 Summit Avenue
Racine, Wisconsin 53404-2374

Change service requested

Non-Profit Org.
U.S. Postage PAID
Racine, WI
Permit No. 137

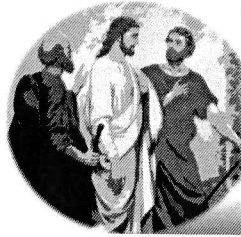

Emmaus Visitor

DECEMBER, 2013

Let Every Heart Prepare Him Room

On Tuesday, December 24, we gather at St. Andrew Lutheran Church, 1015 Four Mile Road, to proclaim the coming of the light. Isaiah announces that the people who walked in darkness have seen a great light. Paul reminds us that the grace of God has appeared, bringing salvation to all. In the familiar account of Christ's birth, the evening sky is bright with the heavenly host singing, "Glory to God in the highest." Amid our broken world we proclaim that the prince of peace is born among us. God comes to us in human flesh-- in Christ's body and blood - so



that we may be bearers of divine light to all the world.

At the 4:30 p.m. service, organist Joyce Kaiser and the Brass Nickel will lead us in Christmas music. Pastor Mary will lead children's time; Pastor Michael will present the sermon. The afternoon service ends with Holy Communion and the congregation singing "Silent Night" by candlelight.

At 6:00 p.m., Pastor Jhon Freddy Correa will lead a Spanish-language candlelight service at Emmaus.

Join us for one or both of the December 24 worship services as we welcome the Prince of Peace!

Emmaus Evangelical Lutheran Church
"Sent Forth by God's Blessing"
e-mail: emmausracine@sbcglobal.net
www.emmausracine.wordpress.com

1925 Summit Avenue
Racine, Wisconsin 53404
Phone: 262 634-5515
Fax 262 634-0835

Pastoral Acts

Baptisms: Azucena Delarosa Alexandra Zuniga October 26, 2013	Azucena and Alexandra are daughters of Martin and Erika Delarosa. Alexandra's sponsors are Luis Romero and Gladys Hernandez. Azucena's sponsors are Alejandro and Laura Rivera.
Kevin Montalvo Emily Montalvo October 26, 2013	Kevin and Emily are children of Fernando and Claudia Montalvo. Their sponsors are José and Rosalinda Soto.
Lillian Jeannette Hamers November 24, 2013	Lillian is the daughter of St. Andrew members Jeff and Margie Hamers. Her sponsors are Jean Horbath and Joseph Sobczak.
Wedding: Leticia Ruvalcaba Jose Luis Ibarra, Jr. November 16, 2013	Pastor Jhon Freddy presided over Leticia and José's wedding at Caledonia Mt. Pleasant Memorial Park.

Please Remember Them in Your Prayers

We extend our condolences to the family of Evelyn Larsen's nephew Lenny Lanser, 58, whose long battle with multiple sclerosis came to an end on November 1.

Please also pray for the family and friends of Jenesse Jones, who



succumbed to cancer November 6 at the age of 44. Jen is the mother of Sydni Matson, a participant in our Neighborhood Camp and the SALT middle school program.

Christmas Party, Cookie Pack Is December 11

The women's Christmas gathering and cookie pack is 1:30 p.m. on December 11 in the Sunset Room. Please bring two dozen or more cookies to share with a shut-in.

All women of the congregation are invited. We hope



you can come, but if you are unable to attend, you can still donate homemade cookies by leaving them in the kitchenette December 7 or 8— be

sure to mark what they're for!

Emmaus Visitor * December, 2013 * Page 2

St. Andrew, Emmaus Join in Spirit of Giving

We have been given two opportunities to share gifts with two groups in our Racine community who will benefit from our generosity — children served in the Emmaus After School for Youth program (EASY) and single women who are a part of the HALO homeless shelter. Trees were placed in the narthex the weekend of November 16 and 17, and all of the HALO tags placed on the trees were taken within the first week!

There is still the opportunity to give to the children in the Emmaus After School for Youth (EASY) program. The way it works is this: take a tag, make a cash donation,



and return it to the church. The elves will do the shopping for books and educational games for the over 40 children registered in the program.

EASY gifts may be made in amounts of \$10.00 or more. The blue ornaments on the trees are attached to envelopes that have varying amounts of suggested donations. Checks may be made payable to Emmaus or to EASY: Memo — Giving Tree.

The deadline for gifts is December 8. Volunteers are welcome to join the elves for a gift-wrapping party Monday, December 9, at 10:00 a.m. in the Emmaus Fellowship Hall.

Mitten Trees to Sprout in December

Warm caps, scarves and mittens made by the Emmaus Knit 1 Purl 1 knitters were displayed in the narthex Sunday, November 24. They were then packed up and taken to Wadewitz School to be given to students in need.

Beginning December 15, there will be an additional opportunity

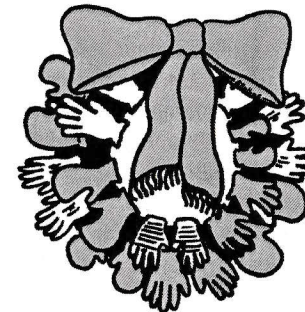

to contribute warm mittens to the Mitten Tree on display at St. Andrew. Mittens of all sizes are welcome (they do not have to be homemade!), and they will be

distributed to North Park, Olympia Brown and Roosevelt Elementary Schools.

Emmaus Visitor * December, 2013 * Page 3

Have You Done Your Christmas Shopping Yet?

A variety of Scrip gift cards are available for sale after Saturday and Sunday worship services. These make great holiday gifts, and we now have free gift card enclosures for your use.

If you don't see what you need, please ask; we can often



order additional gift certificates by the following weekend.

The last order before Christmas will be made on Monday, December 15. If you have questions or special requests, please contact Cathy Meyer at 321-0050.

Annual Reports Are Due in January

Christmas is coming, and with it visions of church council members and organizations preparing their annual reports to the congregation.

In order to present the full report to the congregation a week

before the January 26 annual meeting, the office would like reports turned in by January 13. Reports may be submitted on paper, on computer disk, or by e-mail.

Emmaus Staff & Worship Times

Pastors: Rev. Mary L. Janz	1530 S. Main Street, 53403	262/633-3059
Rev. Jhon Freddy Correa	1909 Summit Ave. 53404	414/881-1403
Council President:	Chris Lamberton	clamberton@wi.rr.com
Church office:	Paul Berge	emmausracine@sbcglobal.net
Education Coordinator:	Nancy Smith	nnsdaisy@aol.com
Director Outreach:	Liliana Moncada	moncada_liliana@hotmail.com
Accompanist:	Brenda Trumbauer	brenda6175@gmail.com
Custodians:	Rich Benson & Antelmo Hernandez	

English language services are held at Emmaus during odd-numbered months every Saturday evening at 4:30, and Sunday mornings at 9:00; we worship at those same times at St. Andrew Lutheran Church, 1015 Four Mile Road, during even-numbered months. Spanish language services are held at Emmaus noon on Sundays; Our Lady of Guadalupe worship services will be at 11:00 p.m. December 12.

Christmas Eve worship services will be offered at 4:30 p.m. (English, at St. Andrew) and 6:00 p.m. (Spanish, at Emmaus) on Tuesday, December 24.

Emmaus office hours are 9:00 a.m. to 3:00 p.m. Monday through Friday (closed December 25).

The VISITOR is published monthly September to July. The deadline for the January VISITOR is December 16. Submit articles to Paul Berge's attention by mail or by e-mail.

Emmaus Visitor

Vol. 42, No. 4

December, 2013

Choir Meets for Advent Anthem

By Brenda Trumbauer

Advent is upon us and I am offering to lead a group for singing an Advent candle lighting song each Sunday. I invite St. Andrew singers to join us and would like to

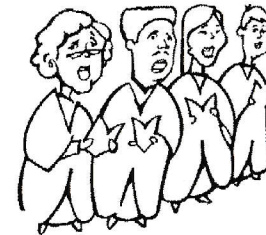

practice after service Sunday mornings at the piano for no more than 30 minutes. Get your coffee and snack and return to sanctuary by 10:35 to sing.

Children Present 'Meet Me at the Manger'

The Emmaus Wednesday night kids will "go on the road" to present this year's Christmas pageant. Join us at St. Andrew (1015 Four Mile Road) Sunday, December 15 at 9:00 a.m. Energetic songs and a fun-filled story, "Meet Me at the Manger," creatively communicate how the gifts of the wise men are relevant today.



service, juice, coffee and treats will be served.

Rehearsal for the pageant will take place Saturday, December 14 at 10:00 a.m. in the St. Andrew sanctuary. If you are able to assist with transportation for the kids either Saturday or Sunday morning, give Nancy Smith a call at 262-672-5859 before 2:30 p.m.

This year's pageant takes the children from Herod's Department Store to a Christmas party at the Lighthouse Mission. There the kids discover that God's desire is for us to have a heart of gold and to give prayer and praise to God. By serving Him in the mission, they learn the true meaning of Christmas. The service will end with the celebration of Holy Communion. Following the

December Youth Birthdays

Dec. 1	Aaliya Arroyo, 5
Dec. 3	Julian Salcedo, 11
Dec. 6	Clarissa Hansen, 6
Dec. 7	Alejandro Medina, 9
Dec. 10	Angel Gutierrez, 4
Dec. 11	LaKenya Lopez, 12
Dec. 15	Joshua Huitron, 3
Dec. 15	Queanna Castulo, 16
Dec. 21	Ashlynn Meteyard, 11
Dec. 22	Janelle Garduño, 8
Dec. 30	Alex Villalobos, 16

Thank You for Your Support in 2013

This holiday season, we thank everyone who has supported Emmaus Lutheran Church this past year with their time, talent and financial contributions and look forward to support from all of our members in the year ahead.

If you need a convenient way to make regular offerings or if you plan to make an additional gift

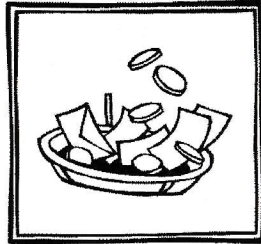

before the end of the year, we encourage you to look into our electronic giving options. As the pace of life speeds up, especially around the holidays, you may find electronic giving a most welcome way to make contributions. Visit www.emmausracine.wordpress.com and click on the "Electronic Fund Giving" icon, or contact the church office for more information.

NorthSide Food Pantry Volunteer Schedule

December 26: Cindi and Loren Larsen, Cheryl Dexter, Dianne Melander

Crunching the Numbers

Weekly worship attendance averages (calculated as of Nov. 24, 2013)

	2011				2012			2013		
	Sat	Sun	Dom	Wed	Sat	Sun	Dom	Sat	Sun	Dom
Oct	15	55	184	59	12	52	142	14	36	185
Nov	15	59	170	57	21	51	201	15	86	181
Dec	13	57	148	n/a	10	48	222			
All Saints' Day				143			138			70
Thanksgiving Eve				36			67			
Adviento				78+376			156+207			
Christmas Eve				125+89			96+284			

Financial Figures

Total for month Year to date
 General Fund offerings received in Oct. '13: \$ 8,814.78
 in Nov. '13: \$10,491.40 \$ 127,270.93

Mortgage retirement offerings received in Oct. '13 \$140.00
 In Nov. '13 \$130.00 Campaign TD: \$73,572.62
 Mortgage payments in Oct., Nov., '13: Principal \$871.67
 Interest \$120.33
 Total \$992.00
 Principal balance as of November 14, 2013: \$22,799.43

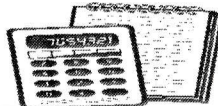

Stewardship Team Effort Is Success

By Carolyn Wooster

Our joint St. Andrew/Emmaus stewardship campaign, Consecration Sunday, concluded Sunday, November 17 with our celebration luncheon. Pastor Gary Liedtke, our guest leader, delivered the stewardship message and call for commitment. Pastor Gary provided a very positive, inspirational experience.

Preliminary results show an estimated \$18,000 increase in pledges for Emmaus.

Six weeks of activities leading to Consecration Sunday included an orientation session and a Leadership Dinner both led by Pastor Liedtke. Sermons, temple talks, bulletin inserts, newsletter article, and letters to members were a part of the communications.

This was truly a team effort with leaders from both Emmaus and St. Andrew. A huge thank you to the following leaders who contributed to such a positive experience:

Chairperson: Carolyn Wooster, Emmaus

Communications Coordinators: Art Smith, Emmaus/Mike Metz, St. Andrew

Luncheon Coordinators: Pat Jensen, Cheryl Dexter, Pastor Mary, Emmaus

Dinner Coordinator: Pam Robers, St. Andrew

Financial Secretaries: Caren Lambertson, Emmaus/Greg Kaser, St. Andrew

Secretary: Steward Nagao, St. Andrew

Committee Member: Kris Nagao, St. Andrew

Pastors: Pastor Mary Janz—Emmaus

Pastor Michael Mueller—St. Andrew

Guest Leader: Rev. Gary Liedtke—St. Luke's Lutheran Church

Temple Talkers: Art Smith, Kris Nagao, Carol Eschmann, Stew Nagao, Cindi Larsen, Greg Kaser

Help started with Sandra Chrostowski from the Greater Milwaukee Synod office.

Thank you, Emmaus and St. Andrew, for such a positive, successful experience.

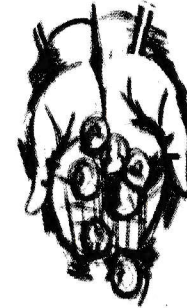

Memorials and Honoraria





Non-designated memorials:

In memory of June Clark: \$100.00

In memory of Marcella Runge: \$25.00

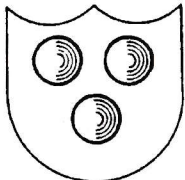
Designated for EASY gifts:

In honor of Eschmann grandchildren: \$80.00

Sunday	Monday	Tuesday	Wednesday	Thursday	Friday	Saturday
1 1 ST SUNDAY IN ADVENT; WORLD AIDS DAY 9:00 am Worship service w/Holy Communion (English) at St. Andrew 10:10 am Coffee & fellowship 10:30 am Coach group 12:00 noon Santa Misa (español) 12:30 pm Kids' Camp	2 10:00 am Knit 1, Purl 1; Sewing group 3:00 pm EASY 6:00 pm Coach group (español)	3 3:00 pm EASY 5:00 pm TOPS 6:00 pm GED class	4 3:00 pm EASY 5:00 pm Supper 5:30 pm 1 st Communion class (español) 6:00 pm God time	5 11:00 am Sun. bulletin deadline 3:00 pm EASY 5:00 pm Community Meal at St. Pat's 6:00 pm GED class	6 ST. NICHOLAS 6:00 pm Support group 	7 PEARL HARBOR DAY 9:00 am Confirmation class (español) 10:00 am 1 st Communion class (español) 4:30 pm Worship service with Holy Communion (English) at St. Andrew
8 2 ND SUNDAY IN ADVENT 8:00 am Musicians' rehearsal 9:00 am Chicago Folk service w/Holy Communion (English) at St. Andrew 10:10 am Coffee & fellowship 10:10 am Blood pressure testing 10:30 am Coach group 12:00 noon Santa Misa (español) 12:30 pm Kids' Camp	9 10:00 am Giving Tree gift wrapping party 3:00 pm EASY 6:00 pm Coach group (español)	10 1:30 pm Clergy meeting 5:00 pm TOPS 6:00 pm Church council mtg. (español)	11 1:30 pm Lydia Circle/ Cookie pack 3:00 pm EASY 5:00 pm Supper 6:00 pm God time	12 OUR LADY OF GUADALUPE 11:00 am Sun. bulletin deadline 4:00 pm BENNU legal appointments 11:00 pm Novena 12:00 m Mañanitas	13 ST. LUCY 6:00 pm Support group 6:00 pm High school youth	14 10:00 am Kids' program rehearsal, at St. Andrew 4:30 pm Worship service with Holy Communion (English) at St. Andrew
15 3 RD SUNDAY IN ADVENT 9:00 am Kids' program (English) with Holy Communion at St. Andrew 10:10 am Coffee & fellowship 10:30 am Coach group 12:00 noon Santa Misa (español) 12:30 pm Kids' Camp	16 LAS POSADAS Jan. Visitor articles due in office 	17 5:00 pm TOPS 6:30 pm Church council mtg. (English)	18  December, 2013	19 11:00 am Weekend and Christmas Eve bulletin deadline 6:00 pm GED class	20 6:00 pm Support group 	21 ST. THOMAS 4:30 pm Worship service with Holy Communion (English) at St. Andrew
22 4 TH SUNDAY IN ADVENT 9:00 am Worship service w/Holy Communion (English) at St. Andrew 10:10 am Coffee & fellowship 10:30 am Coach group 12:00 noon Santa Misa (español) 12:30 pm Kids' Camp	23	24 4:30 pm Worship service (English) at St. Andrew 6:00 pm Misa Navideña (español) at Emmaus	25 CHRISTMAS <i>Offices closed</i>	26 ST. STEPHEN; KWANZAA 11:00 am Sun. bulletin deadline 4:00 pm BENNU legal appointments	27 ST. JOHN 6:00 pm Support group 6:00 pm High school youth	28 HOLY INNOCENTS 4:30 pm Worship service with Holy Communion (English) at St. Andrew
<i>Pastor Mary on vacation</i>						
29 1 ST SUNDAY OF CHRISTMAS 9:00 am Worship service w/Holy Communion (English) at St. Andrew 10:10 am Coffee & fellowship 12:00 noon Santa Misa (español) 12:30 pm Kids' Camp	30 	31 12:00 noon 2013 offering deadline (for IRS purposes) 5:00 pm TOPS	Jan. 1, 2014 NAME OF OUR LORD <i>Offices closed</i>	2 11:00 am Bulletin deadline 6:00 pm GED class	3 6:00 pm Support group	4 4:30 pm Worship service w/HC (English) at Emmaus
<i>Pastor Mary on vacation</i>						

Coffee Makes a Great Gift

Mt. Meru fair trade coffee is for sale after worship services on Saturday and Sunday. In addition to the regular varieties available, we are offering a gift pack ready for holiday giving. The holiday gift

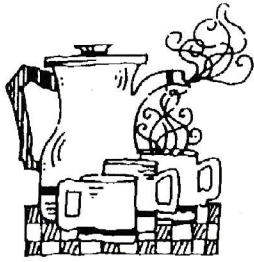

bags include a reusable Maasai shuka pattern cloth bag woven in Tanzania, an ornamental beaded coaster made by local women in Tanzania, an imprinted coffee scoop, and a bag of delicious Mt. Meru Coffee (your choice of flavor). This holiday gift bag sells for \$18.

FaithWorks Briefs

Our Savior's Approves Partnership with Atonement

The members of Our Savior's Lutheran Church - Racine voted on November 24 to continue to move forward with the partnership of shared ministry, shared staffing, and shared worship services with Atonement Lutheran Church. Members also voted to have all Sunday worship services

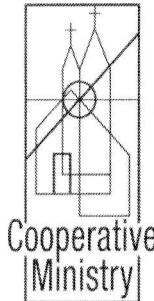

held at Atonement Lutheran Church, beginning January 5, 2014.

Youth Meet at Emmaus

FaithWorks high school youth (grades 9-12) meet at Emmaus on second and fourth Friday nights at 6:00 p.m. until 8:00 p.m. The next gathering is on December 13. Contact Brenda Trumbauer or Rich Benson, 681-3833, for details.

Bible Readings in December

- December 1: Isaiah 2:1-5; Psalm 122; Romans 13:11-14; Matthew 24:36-44.
- December 8: Isaiah 11:1-10; Psalm 72:1-7, 18-19; Romans 15:4-13; Matthew 3:1-12.
- December 15: Isaiah 35:1-10; Psalm 146:5-10; James 5:7-10; Matthew 11:2-11.
- December 22: Isaiah 7:10-16; Psalm 80:1-7, 17-19; Romans 1:1-7; Matthew 1:18-25.
- December 24: Isaiah 9:2-7; Psalm 96; Titus 2:11-14; Luke 2:1-14 [15-20].
- December 29: Isaiah 63:7-9; Psalm 148; Hebrews 2:10-18; Matthew 2:13-23.

Environmental Stewardship

Sometimes Earth Feels Like a Motherless Child

by John Berge

In Bible Study class, it was said that burial in the earth can be likened to returning to the womb when we die. That fits well with the common image of Mother Earth.

But how well have we been treating our Mother Earth? We dump our pollution into the air and water; we cover the ground with landfills that often become the highest point in the region; we dig huge pits in forests and mountains to remove ores, coal, and sand with which to fracture deep layers of the earth's skin, we ignore the needs of future generations for our immediate satisfaction; we give Mother Earth a fever by loading the atmosphere with more greenhouse gases than has been seen for thousands (millions?) of years and which will only get worse if we don't change our ways quickly.

On the other hand, Mother Earth hasn't been treating her children too well either. Typhoons have hit Mexico and the Philippines recently with such devastating and deadly effects. Hurricane Sandy, floods across Europe and the US, "great earthquakes, and in places famine

and plagues", tornadoes in the Midwest, water and food shortages and other "natural" disasters have shown her power.

Rather than comparing the earth to a mother, William Paul Young in his very thought-provoking book *The Shack* has Jesus comparing the earth to a child. "Our earth is like a child who has grown up without parents, having no one to guide and direct her. Some have attempted to help her, but most have simply tried to use her. Humans, who have been given the task to lovingly steer

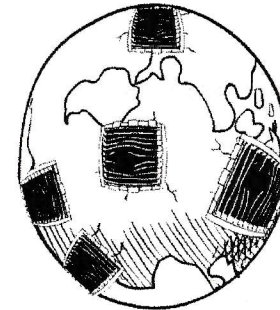

the world, instead plunder her, with no consideration other than their immediate needs. And they give little thought to their own children, who will inherit their lack of love. So they use her and abuse her with little consideration, and then when she shudders or blows her breath, they are offended and raise their fist at God."

As I write this, I haven't quite finished reading the book, which has been around for half a dozen years, but I can heartily recommend it to those who would take another and different look at the triune God.

Kenosha Chamber Choir Sings Messiah

The Kenosha Chamber Choir presents a concert of selections from Handel's "Messiah: An Oratorio" at 3:00 p.m. Sunday, December 1 at St. Matthew's

Episcopal Church, 5900 Seventh Avenue in Kenosha. Suggested donation is \$9.00 for adults, \$7.00 for seniors and students.

Carthage Presents Christmas Concert

Carthage College invites the community to the annual Carthage Christmas Festival, three performances of readings and music in the A. F. Siebert Chapel. Tickets to the Christmas Festival are free. Concert times are 7:30

p.m. Friday, December 6; 7:30 p.m. Saturday, December 7; 4:00 p.m. Sunday, December 8. For information and reservations, call the Chapel Office at 262-551-5810 between 8:00 a.m. and 4:00 p.m. Monday-Friday.

Emmaus and St. Andrew must soon place your order for poinsettias to decorate the St. Andrew sanctuary on Christmas Eve this year. Please place your order today.



My/our name/s
Please reserve # _____ poinsettias at \$12.00 each
(# _____ red # _____ white # _____ pink)
In memory of
.....
and/or to HONOR

Deadline to order and make payment is December 3, 2013. Please place your order in the offering plate or leave it in the church office mailbox. Please make checks payable to St. Andrew Lutheran Church and designate that it is for your poinsettia order.

I will pick up my poinsettia after the worship service Dec. 24.
 Please give my poinsettia to a shut-in.
 I would like to deliver poinsettias to shut-ins.

Office use: Pmt: Order list:

ELCA Disburses \$1M for Philippines Typhoon Relief

CHICAGO (ELCA) -- The Evangelical Lutheran Church in America (ELCA) provided \$1 million to support immediate relief efforts for survivors of Typhoon Haiyan, which struck the Philippines Nov. 8. The funds were disbursed through Lutheran Disaster Response to Lutheran World Relief.

"We are showing up," said the Rev. Elizabeth Eaton, ELCA presiding bishop. "Lutheran Disaster Response, working through Lutheran World Relief, is meeting the immediate needs of people affected by this storm. This means that our entire church is on the ground in the Philippines, and we will stay there until the work is done. We are a church that does God's work with our hands," she said.

The relief funds will provide for the distribution of cooking utensils, shelter repair kits and debris removal.

"Lutheran World Relief is a tried and true partner," said Carl Stecker, ELCA director for global diakonia. "Their long presence in the Philippines and their experience in disaster response, recovery and development provide strong reason to have confidence that our \$1 million commitment will be used to meet

the immediate and longer term recovery needs in some of the hardest-hit areas. We know that they are results-oriented and will provide systematic and timely reports of their activities. We are proud to partner with them," he said.

According to the United Nations, at least 9 million people are affected and more than 600,000 are displaced from their homes as a result of the storm. Widespread destruction has complicated relief efforts, leaving thousands stranded in at least eight regions of the country.

Lutheran Disaster Response International will also provide assistance through the Lutheran Church in the Philippines, an ELCA companion. The response will be coordinated with The Lutheran World Federation.

Financial gifts to Lutheran Disaster Response will be used 100 percent to support relief efforts for all survivors impacted by the typhoon. Information about Lutheran Disaster Response is available at www.ELCA.org/typhoon.

Lutheran World Relief is an independent Lutheran agency that works with community-based partners.



Help those in need

Some Days, It Is a Lot Harder to Be Patient

Really, does God answer prayers?

Have you felt that God is too slow to answer? Or have you felt that God does not care? There have been other people like me and perhaps you, who have felt this as well. For instance, the Psalmist says;

"How long, Lord? Will you forget me forever? How long will you hide your face from me? How long must I wrestle with my thoughts and day after day have sorrow in my heart?

How long will my enemy triumph over me? Look on me and answer, Lord my God. Give light to my eyes, or I will sleep in death, and my enemy will say, 'I have overcome him,' and my foes will rejoice when I fall." (Psalm 13).

I want to share with you today part of God's journey with me. From day one, ever since God started the Latino Ministry at Emaús in 2008, it has flourished! God's power has been unleashed, liberating people to live a better life. This is what was experienced daily among the people of Emaús.

Because of that growth and the demands of this wonderful ministry, I started praying to God

for help--human and financial help, time, health, energy, among others. There is no doubt that God responded, but not in the way I had imagined or wanted, which is a reminder that I am not alone in this waiting.

Also, this waiting and not receiving things the way I wanted

things done made me wonder if I was not clear with God about what I wanted. And/or if didn't get, what God is doing with my life? Anyway, it

was "only" five years later when God sent someone! I give thanks to God for still sending angels, who don't have wings but hands and hearts ready to love and spread out God's power, which is love!

I give thanks to God for Gabriel Marcano. Gabriel is from Venezuela and has served as an Anglican Catholic priest there. He joined Emaús in March and is now in the candidacy process in our synod.

Let us go back to God's journey with me. Does one skip and ignore those five years in the waiting/wilderness? For some, there were 40 years; Sarah and

→ Please turn to page 15



Emmaus to Serve Community Meal December 5

It's Emmaus' and St. Andrew's turn to provide food for the December 5 Community Meal at St. Patrick's Church. Please you sign up to provide a casserole,



cake or jello, or to help serve.

The pans and covers are in the cupboard in the kitchen off the Sunset Room. Thank you for your continued support of this program.

Pastor Jhon Freddy's Column

→ Continued from page 14

Abraham waited a long time for a child. And what about Job, Moses, Jacob, Saul, Samuel, David, and a loving father (Luke 15:11-24), among others? During this waiting there is lot of brokenness, tears, suffering, anger, frustrations, which often times numbs us to a point where we don't see those around us. The sad thing is that during these wilderness times we can end up causing a lot of harm.

During this season where the church teaches about waiting, let us make an effort to be mindful of who is around us, who needs a hug, a word, an ear, a hand, a set of eyes. Let us see them as who they are--loving, caring, broken children of God!

"Truly I tell you, whatever you did for one of the least of these brothers and sisters of mine, you did for me." (Matthew 25:40)

Year's End Brings Deadlines

Articles for the January *Visitor* need to be in the church office or e-mail by December 16.

As far as the IRS is concerned, the deadline for getting your 2013 offerings to church is Monday, December 31. If you bring your donation here in person, you will need to see Paul Berge before noon that day; we will, however, credit any offerings bearing a December 31 postmark as having been given in 2013. On the



other hand, there is no deadline for asking a contribution to be applied

to your 2013 pledge. You may also make early contributions toward your 2014 pledge. Just make a notation on your offering envelope to let us know which pledge to apply your offering to.

2013 giving statements will be mailed in early January to all members who have made an offering of record during the year.

In the December Visitor:

-  ***Gift Wrap and
Cookie Pack***
-  ***Giving, Mitten Trees***
-  ***Advent Choir Anthem***
-  ***'Meet Me at the
Manger'***
-  ***Stewardship Report***
-  ***Mt. Meru Coffee***
-  ***Earth Child***
-  ***Poinsettia Order Form***
-  ***ELCA Typhoon Haiyan
Response***
-  ***Being Patient***

Emmaus Evangelical Lutheran Church
1925 Summit Avenue
Racine, Wisconsin 53404-2374

Change service requested

Non-Profit Org.
U.S. Postage PAID
Racine, WI
Permit No. 137

Cual es el propósito de que Emaus exista?

O sea

Para que , Por que Existe Emaus?

Emaus

Una estrella en medio de la oscuridad!

Enero – Febrero
2013



Felicitaciones a la primera Clase de Confirmación en Emaus!

Dentro!

- Clases personalizadas de Ingles
- 2 Clases de G.E.D: Matemáticas y Lectura y escritura
- Miércoles de ceniza: Feb 13 @7:00pm
- Peregrinación los Miércoles en otras Iglesias de Racine. Fe es Acción!
- New Grupo COACH apoyo-consejería. Lunes 6:00pm
- Aprobación de la misión 2013 de Emaus
- Emaus sirve cena comunitaria en St. Patricio en Febrero 7
- Febrero. 10
 - * Renovación de promesas matrimoniales
 - * Charla sobre Hipotecas de CASAS
- Febrero 17 de 1:30-4pm Jóvenes de 6-12 grados se van de **BOWLING**.
- Familias que ofrecieron sonrisas a los niños de Emaus con la ofrenda de las uvas.
- Familias que cocinan en Emaus!

Al hacerme la pregunta: Cual es el propósito de esta Parroquia? Tengo que confesar que tuve que pensarlo un "buen" tiempo.

Respuestas como: Tu crees que nuestro propósito es solo hacer misas, Bautizos, Primeras comuniones,, confirmaciones, quinceañeras, matrimonios, funerales, visitar enfermos, consejerías, visitar presos, ayudar a los jóvenes, tener programas después de la escuela, escuela de música, ofrecer clases de ingles, G.E.D en español, tener un programa de comida-dispensa, ayudar una vez al mes a San Patricio con la cena comunitaria donando comida, ayudar a los mas necesitados en México compartiendo remesas, amor y ayudando a crear pequeños negocios que promuevan mejores vidas, enseñar la fe a nuestros pequeños, crear iniciativas de microempresas, dar entrenamiento de superación personal, entre otras cositas mas que hacemos?

Entre estas y otras cositas mas que hacemos, me pregunte será eso lo mas importante? O cual será nuestra misión? Tu que piensas? Comparte tu respuesta al menos con tres personas! Feliz cuaresma= cuarenta días con PROPOSITO!

Clases de
GED
en Español
en Emaus



Febrero 10

Ven y Renueva tus promesas
Matrimoniales
MISA 12:00
REGISTRA A TU PAREJA!
DA EL MEJOR REGALO DE SAN
VALENTIN



**"OPCIONES PARA PARAR LA EJECUCION
HIPOTECARIA"**

No Pierda su casa!
QUIERE COMPRAR CASA?
INFORMESE!



Seminario Gratuito
en La Parroquia Emaus

1925 Summit Av. Racine 262 634 55 15 Ext. 2

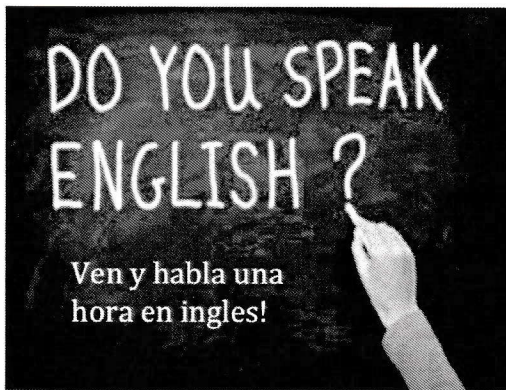

Clases personalizadas...
Miércoles 6:00pm
Cena : 5:15pm

Ven y habla una
hora en ingles!

Febrero 10, 2013
1:45 pm.

**Modificación de Préstamos reducir su pago
mensual de la hipoteca (s).**



Detener la subasta judicial
**Detener la venta de inmediato y obtener un
mejor pago.**

**Plan de venta corta y préstamo de exclusión y
sale con dinero en efectivo en su bolsillo y sin
juicio alguno.**

**Venga y haga todas las preguntas, dudas
que tenga sobre su casa en cuestión de
finanzas! Un experto le contestara!**

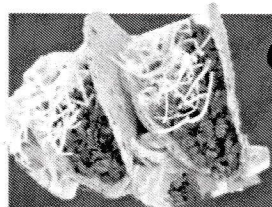

Quienes cocinan?
**Gracias por sus
esquisitos platillos!**

Leticia Diaz,
Jose Llamas, Trini, Esperanza,
Yesenia y Veronica, y Veronica

BOWLING Febrero 17

A Paradise West Bowling Alley \$ 10 por
persona incluye 2 ½ de
Bowling, shoes, pizza
& soda. Reservar
antes del 9 de
Febrero.



UN SIGNO QUE PUEDE CAMBIAR TU VIDA.

Miercoles de ceniza
13 FEB

GRATIS EN LA PARROQUIA EMAUS
7:00 PM



CUARESMA: Señales para el camino

Caminar por el desierto es la pedagogía de Dios que lleva a los hombres a buscar dentro de sí mismos su propio camino.

- ... Oración
- ... Solidaridad
- ... Ayuno
- ... Entrar en uno mismo
- ... Visitar a los enfermos

PEREGRINACION POR RACINE CON LAS 5 IGLESIAS DE FE ES ACCION

- FEB 13:** Parroquia EMAUS * MIERCOLES DE CENIZA @ 7:00pm
- FEB 20:** San Andrew 1015 Four Mile Rd (Donde fue el festival!) @ 6:00pm
- FEB 27:** Redeemer 2417 Drexel Av. @ 6:00pm
- Marzo 6:** Atonement : No te pierdas *LOS MIMOS* 2915 Wright Av. @ 6:00pm
- Marzo 13:** Our savior- 2219 Washington Av. (Esquina d ela Washington y la Taylor)
 Vendra un señor que era parte del grupo de white supremacist. Y contara su testimonio
 Este grupo solo defendia la supremacia de los blancos (Esquina). @ 6:00pm
- Marzo 20:** Parroquia Emaus 1925 Summit Av. @ 6:00pm Video de la Historia de Emaus!



La idea de esta peregrinacion es: Conocer las otras Iglesias, que es lo mas importante para ellos? Que es lo major que hacen? Que valoran mas? Que les causa mas alegria?

CUARESMA
 CUARENTA  DIAS

CON CRISTO Y CON PROPOSITO



Gracias a:

Familias Altamirano,
Mendoza, Luna
Rodriguez, Mendoza
Rojas, .

Por traer con la ofrenda
de las uvas sonrisas
a los niños en Emaus

GRACIAS!!! GRACIAS A TODOS LOS QUE
CONSTRUYEN UNA MEJOR COMUNIDAD!
GRACIAS POR TU COMPROMISO!



COMING SOON!

Marzo 6, 2013

6:00pm

Nunca antes visto...

Mimos representando la pasion
de Cristo!

Marzo 6 @ 6:00pm

Peregrinación en CUARESMA de cinco Iglesias que se
unen para servir a la comunidad de Racine! Quieres
UNIRTE a peregrinar para hacer la diferencia?

Unidos haremos mas! Unidos somos mas fuertes!!!

*Quieres servir a
Dios en esta
CUARESMA y
no sabes como?*

Inscribite para ser:

- Lector
- Cocinar
- Enseñar a los niños, jóvenes.
- Preparar el altar
- Ofrecer el pan y vino, las uvas
- Ayudar con el computador, el sonido
- Ujier

El amor de Dios, la
esperanza y el perdón a
través de Jesucristo

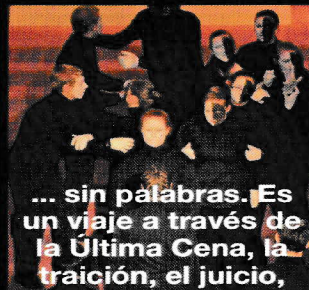

... sin palabras. Es
un viaje a través de
la Última Cena, la
traición, el juicio,

**free
Gratis**

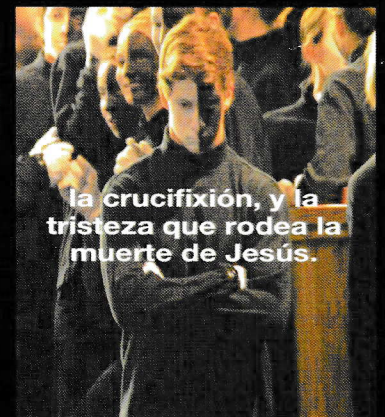

la crucifixión, y la
tristeza que rodea la
muerte de Jesús.



te invita Parroquia Emaus

Lugar: 2915 Wright Ave Atonement Lutheran Church

EMAUS

Servicios para la comunidad

- Cual es La misión de Emaus para el 2013?
- Clases personalizadas de ingles.
- G.E.D: Matemáticas escritura y lectura.
- COACH: Grupo de onsejeria de apoyo.
- CLASES DE MUSICA.
- Información sobre las hipotecas de vivienda- Feb 24.
- Familias que cocinan en Emaus.
- Programas después de la escuela.

Servicios Eclesiásticos.

- Que es Miércoles de ceniza?
- Charla de Parejas: **El amor sí tiene precio!** Marzo 10 @ 2:00pm con almuerzo incluido!
- * Parejas del mismo sexo Feb. 10:15 con desayuno!
- Visitas a enfermos y presos. - Bautizos,



"HEMOS HECHO TODO, PERO NO MUCHO"

¡FALTAS TU, TE NECESITAMOS!



En el 2006, millones de personas se congregaron en protestas por una reforma integral contra las leyes de inmigración existentes en Estados Unidos. Las protestas comenzaron en respuesta a la propuesta legislativa conocida como H.R. 4437, que aumentaría las penalidades para la inmigración indocumentada, y clasificaría a los extranjeros indocumentados y a cualquier otra persona que los ayudase a entrar o permanecer en los Estados Unidos como criminales.

¿Qué es la Cuaresma?

La Cuaresma ha sido, es y será un tiempo favorable para convertirnos y volver a Dios Padre lleno de misericordia.

No es un tiempo para que sufras!

COACH

GRUPO DE CONSEJERIA Y

APOYO El Apoyo Emocional va dirigido a cualquier persona que esté interesada en realizar una mirada interior y recuperar la paz, la alegría y el equilibrio emocional en su vida. Es súper sencillos: es buscar que esta pasando en tu vida hoy y descubrir a donde quieres llegar, como hacerlo, que herramientas tienes, que te detiene?

Regístrate para hacer tu CONFIRMACION! 634-5515

GRACIAS Y BENDICIONES PARA ESTOS LIDERES QUIENES ESTAN SIRVIENDO A DIOS EN EL MES DE FEBRERO!

AMELIA, BALVINA, LETICIA G, LUPE F., MARIA Y ANEGELICA V., ALONSO Y CINTHYA G., AMAYRANY Y NOHEMY O., SOLEDAD, LUZ, LETICIA, TRINIDAD, ANTELMO, OMAR V, GINA T, JESSICA, JOSHUA Y BRYAN G., EVA Y EDI.

If you have HIGH BLOOD PRESSURE or DIABETES?



GET SCREENED

SATURDAY, MARCH 2

9 am-1 pm

FREE

262 821 0705

Lord of Life Lutheran Church • 5601 Washington Rd. • Kenosha, WI 53144

Get Screened Kidney Early Evaluation Program (KEEP) offers:

- Anyone over 18 who has high blood pressure, diabetes or a family history of kidney problems should get tested.
- Blood and urine tests for diabetes and kidney disease

* Talk one-on-one with a doctor about results

Walk-ins welcome.

Appointments/Information: 262-821-0705

Miércoles de Ceniza:

inicio de la Cuaresma
La imposición de las cenizas nos recuerda que nuestra vida en la tierra es pasajera y que nuestra vida definitiva se encuentra en el Cielo.



La Cuaresma comienza con el Miércoles de Ceniza y es un tiempo de oración, penitencia, ayuno, crecer y compartir. Cuarenta días que la Iglesia marca para la conversión del corazón!

La imposición de ceniza es una costumbre que nos recuerda que algún día vamos a morir y que nuestro cuerpo se va a convertir en polvo. Nos enseña que todo lo material que tengamos aquí se acaba. En cambio, todo el bien que tengamos en nuestra alma nos lo vamos a llevar a la eternidad. Al final de nuestra vida, sólo nos llevaremos aquello que hayamos hecho por Dios y por nuestros hermanos los hombres y mujeres. Desde el momento que el sacerdote nos impuso la ceniza, debemos de tener una actitud de querer mejorar, de **querer tener amistad con Dios.**

Te invitamos a comer



el domingo despues de misa en el base man no faltes! Ven y haz mas amigos y busquemos soluciones juntos!

Reunion comunitaria en Emaus con una caravana Nacional
Feb. 22 a las 6:00pm



LA CUARESMA

El tiempo de la Cuaresma recuerda los cuarenta años que el pueblo de Israel pasó en el desierto mientras se encaminaba hacia la tierra prometida. Este tiempo les implicó fatiga, lucha, hambre, sed y cansancio... pero al fin el pueblo elegido gozó de esa tierra maravillosa, que destilaba miel y frutos suculentos (Éxodo 16).

También para nosotros, como fue para los israelitas aquella travesía por el desierto, la Cuaresma es el tiempo fuerte del año que **nos prepara para la Pascua** o Domingo de Resurrección del Señor. Celebramos la victoria de Cristo sobre el pecado, la muerte y el mal. **La Pascua es la fiesta de alegría** porque **Dios nos hizo pasar de la oscuridad a la luz**, de la tristeza al gozo profundo, de la muerte a la vida!

La Cuaresma ha sido, es y será un tiempo favorable para convertirnos y volver a Dios Padre lleno de misericordia.

Te acuerdas de la historia del hijo prodigo? (Lucas 15, 11-32) Algunas veces a mi me ha pasado lo del hijo menor y a ti?

Que tal en esta cuaresma una buena confesión de nuestros pecados. Dios siempre tiene las puertas abiertas de par en par. Yo creo que el corazón de Dios se rompe en pedazos si EL no comparte con nosotros su amor hecho perdón generoso. ¡Ojalá fuéramos muchos los pecadores que valientemente volvamos a Dios en esta Cuaresma para que una vez más experimentaran el calor y el cariño de Dios!

En esta semana CUARESMA que tal si practicamos el ayuno, la oración y **sobre todo la ayuda al prójimo.**

Adaptado de P. Antonio Rivero, L.C.

Charla de PAREJAS:

"El amor si tiene un precio!"

MARZO 10 @ 2:00pm con almuerzo incluido

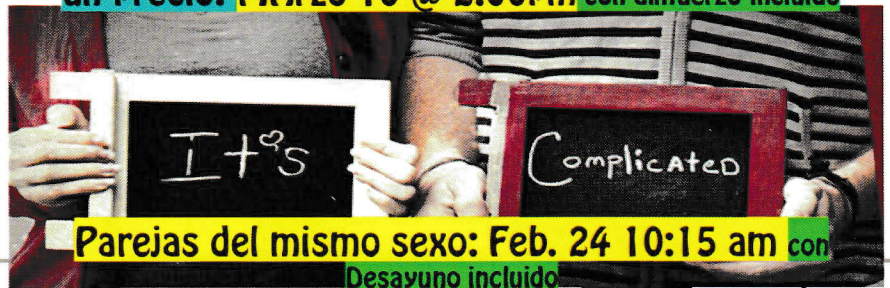

Parejas del mismo sexo: Feb. 24 10:15 am con Desayuno incluido

Mensaje del Pr. Jhon Freddy Te molesta y te fastidia que:

La gente critique, que no trabajen, que te roben, que te griten, que no te escúchen, que no se comprometan contigo, que tus hijos no estudien, que no respeten, que jóvenes se emborrachen, fumen, que los políticos no cumplan, que tus vecinos hagan mucho ruido, que cuando necesites un favor no te lo hagan? Te molesta algunas de estas cosas y otras? A mi también! Y Pensando en la vida me pregunte...

y cuantas de esas cosas que me molestan YO SOY EL PRIMERO QUE LAS HAGO? En esta cuaresma recuerda las palabras de San Mateo 7:3
¿Y por qué miras la paja que está en el ojo de tu hermano, pero no consideras la viga que está en tu propio ojo?

Clases de G.E.D en Español

EL GED es un equivalente del diploma de preparatoria (high school). En inglés, el Diploma de Educación General o GED es conocido como "General Education Development".

Es importante que te prepares para el examen de GED. Si dejaste de asistir a la preparatoria en el grado 11 o 12, es posible que puedas tomar el examen sin tomar un curso de preparación. Sin embargo, si abandonaste los estudios hace más de un año o antes del onceavo grado, es posible que debas tomar el curso.

Tu maestro te dirá cuánto tienes que estudiar para aprobar el examen de GED.
Te gustaría prepararte?
Aquí puedes encontrar la oportunidad para que lo logres!

Nunca es tarde para Estudiar!

Registrate: (262) 634-5515 Ext. 2

Clases Martes & Jueves
6:00pm.

En pleno siglo XXI con tanta información y con tantos avances científicos, es incomprensible que el ser humano no sepa resolver sus problemas personales y familiares y siga batallando para vivir en armonía, como dijo Martín Luther King Jr.: **"Los seres humanos hemos aprendido a volar como las aves, también a nadar como los peces, pero no hemos aprendido a vivir como hermanos"**.

PORQUE APRENDER INGLES?

Sin tener destreza en el inglés, los inmigrantes sufren y fracasan en su economía, sus logros académicos y socialmente. Aun peligran sus vidas. ¿Puedes leer esto?:

"Hazardous to humans and domestic animal"

CAUTION. Harmful if absorbed through the skin. Avoid contact with skin, eyes or clothing.

Wash hands thoroughly with soap and water after handling and before eating and drinking.

Remove and wash contaminated clothing before reus

Si no puedes leer lo de arriba corres un gran peligro al no entender esta advertencia de un producto que es tóxico para quien lo maneje incorrectamente y llega a tener contacto en su piel o su ropa.

Etiqueta en español tiene error en instructivo para fórmula de bebé.

Cientos de lotes de fórmula para infantes fueron retiradas del mercado cuando se descubrió que las instrucciones en español estaban incorrectas. Como estaban escritas, las instrucciones en español creaban un producto que podía causar ataques, arritmias, falla renal y muerte a los infantes. (The Arkansas Democrat-Gazette, Julio 11, 2001.)

APRENDE INGLES en Emaus- Clases PERSONALIZADAS.

MIERCOLES 6:00PM

VEN Y HABLA UNA HORA Puro INGLES!

A lo mejor para la reforma migratoria piden que hables ingles para arreglar - empieza desde ya!

Calendario: PEREGRINACION POR RACINE CON LAS 5 IGLESIAS DE FE ES ACCION

FEB 20: San Andrew 1015 Four Mile Rd (Donde fue el festival!) @ 6:00pm

Ven y escucha a la persona que fue ganguera, drogadicta abusada por sus propios familiares, estuvo en la cárcel. Ven y escucha HOY quien es?

FEB 27: Redeemer 2417 Drexel Av. @ 6:00pm África es vida- Ven y te sorprenderás. Un misionero de África y su vida!

Marzo 6: Atonement : No te pierdas *LOS MIMOS* en la 2915 Wright Av. @ 6:00pm

Marzo 13: Our savior- 2219 Washington Av. (Esquina de la Washington y la Taylor) @ 6:00pm

Ven para que te quedes con la boca abierta al escuchar esta historia! un señor que era parte del grupo de white supremacist. Y contara su testimonio. Este grupo solo defendía la supremacía de los blancos.

Marzo 20: **Parroquia Emaus** 1925 Summit Av. @ 6:00pm Video de la Historia de Emaus! Y la obra de Teatro dirigida por los niños de Emaus!

La idea de esta peregrinación es: Conocer las otras Iglesias, que es lo mas importante para ellos? Que es lo mejor que hacen? Que valoran mas? Que les causa mas alegría?

Semana SANTA 2013



Domingo de Ramos- Misa 12:00. Entrada triunfal de Jesucristo en Jerusalén.

Lunes Santo. Unción de Jesús en casa de Lázaro. Jesús expulsa a latigazos a los mercaderes del Templo de Jerusalén.

Martes Santo. Jesús anticipa a sus discípulos la traición de Judas y las Negaciones de San Pedro.



Miércoles Santo. No te lo puedes perder. LA obra de teatro de la pasión de Cristo hecha por los niños en Emaus!
Y recuerda hasta el burro de carne y hueso vendrá!

Jueves Santo. Lavatorio de los pies. La Última Cena. Eucaristía. Oración de Jesús en el huerto de Getsemaní. Arresto de Jesús.

Cena familiar desde las 4pm- 7pm.

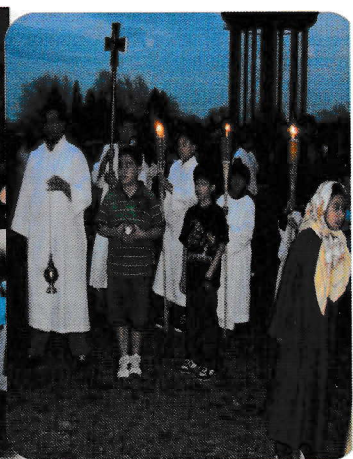
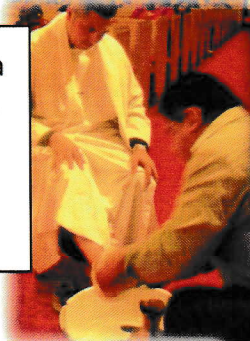

Viernes Santo. Arrestan a Jesús. Los interrogatorios de Herodes y Pilato. La flagelación. La coronación de espinas. Vía Crucis. Crucifixión de Jesús. Sepultura de Jesús.



Sábado Santo.
Vigilia Pascual
Bendición del Fuego!
Bautizo de Adultos.
Nos uniremos 5 iglesias para celebrar esta gran noche! En la 2915 Wright Av.
A las 7:00pm

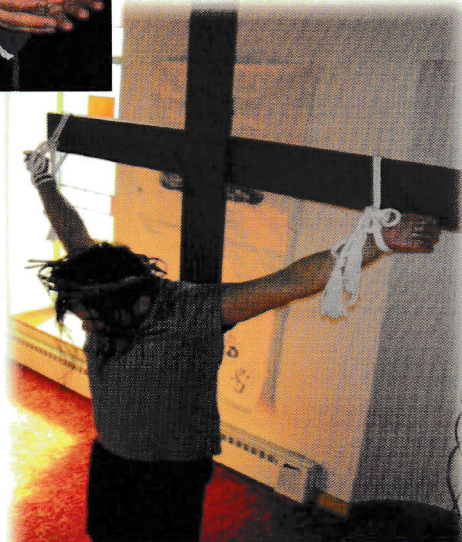

Domingo de Resurrección. Pascua.
Misa 12:00



SEMANA SANTA 2013

Y tu que le daras
a Dios en esta
SEMANA

Una vez un hombre rico le entrego una canasta con basura a un NIÑO POBRE, el NIÑO sonrió y corrió con la canasta, la vació, la lavo, la lleno de flores y se la dio de regreso, el hombre rico se asombro y le pregunto. ¿ Por qué me has dado flores si yo te di basura ? EL NIÑO contesto y dijo: por que cada uno da lo que tiene en el CORAZÓN.

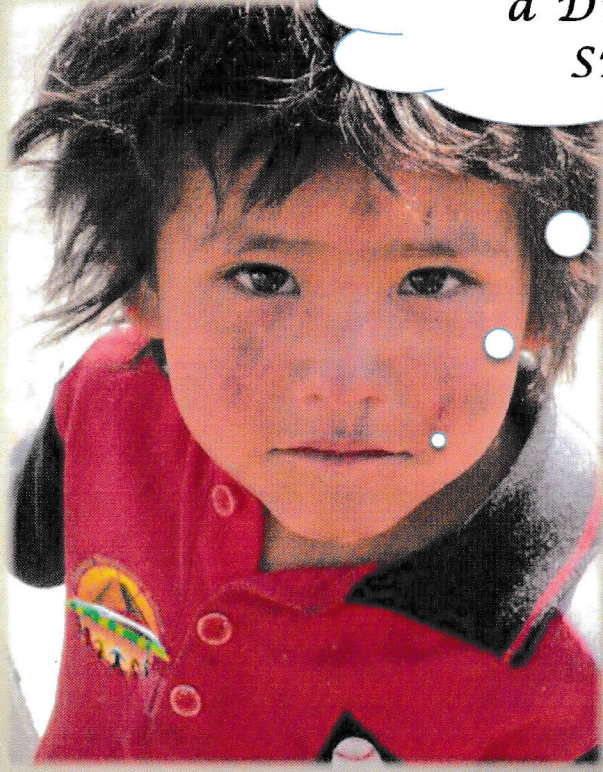

LA GRAN IMPORTANCIA DE TENER METAS en la vida.

La vida nos ofrece dos opciones: Puedes **vivir** o **sobrevivir**.

Para vivir bien debes determinar lo que quieres. Eres de los que dicen que no te alcanza el tiempo? Te gustaría organizar tu tiempo.

En esta semana santa escribe las metas que Dios tiene para tu vida.

Enfócate en lo que desees.

Recuerda "Una vida sin objetivos, sin metas es como un barco sin timón."

Te invitamos a participar de una de las GRANDES metas de Emaus: Es ayudarte a aprender a cómo llegar a tus metas. El Apoyo Emocional va dirigido a cualquier persona que esté interesada en realizar una mirada interior y recuperar la paz, la alegría y el equilibrio emocional en su vida. Estas buscando eso?

Únete al grupo de más de 12 personas que decidimos arriesgarnos a aprender a vivir mejor! Todos los Lunes 6:00pm

No te pierdas la oportunidad de superarte! Te esperamos!

HORARIO Semana santa.

Domingo de Ramos. Entrada triunfal de Jesucristo en Jerusalén.
MARZO 24 @12:00pm

Jueves Santo. CENA GRATIS en Emaus. De 4:00-7:00pm.

Lavatorio de las manos o pies. Una GRAN Cena Mexicana. Cada Hora la Eucaristía. Oración de Jesús en el huerto de Getsemaní.

Una experiencia que no te la puedes perder! 7:00pm sera la Bendicion Final

Viernes Santo. 7:00pm Viacrucis VIVIDO en carne propia! en las 4 Millas, Iglesia San Andres 1015 Four Mile Rd. Racine, otra super experiencia espiritual. Habra cuidado de niños. Ven y tu mismo toca la corona llena de espinas, clava en la cruz, escucha ese horrible sonido, levanta aquella cruz pesada, ven y vive esta hermosa experiencia.

Sábado Santo: 7:00pm

en la iglesia de Atonement 2915 Wright Ave Vigilia Pascual-Resurreccion: Bautizos de adultos. No te haz bautizado? Este es un gran dia! Bendicion del fuego y mucho mas!

Domíngo de Resurrección. Pascua. Misa en Emaus a las 12:00

¿QUÉ ES LA SEMANA SANTA?

La Semana Santa conocida también como la semana mayor. Esta semana para muchos se ha convertido sólo en una semana más en el año. Nos hemos olvidado de lo esencial: Te gustaría dedicarte en esta semana a la oración y la reflexión? Entrando en lo más íntimo de la Pasión y Muerte de Jesús para aprovechar todas las gracias que esto nos trae.

Por que participar de las actividades de mi parroquia?

Es acompañar a Jesús. Es vivir en oración. Es arrepentimos para recibir esa nueva vida.

Lo importante de esta semana mayor es entender por qué Jesús murió? Que significa que Jesús haya resucitado? Este tiempo no es para estar tristes. Al contrario es para celebrar y revivir su entrega a la muerte por amor a nosotros y el poder de su Resurrección. Es alegrarnos porque hay una nueva vida para ti y para mí!

La Semana Santa fue la última semana de Cristo en la tierra. **Que harías esta semana mayor- si supieras que fuera tu última semana con aquellas personas que amas?** Que te detiene a hacerlo?

La liturgia del Domingo de Ramos.

La liturgia del Domingo de Ramos es una de las más intensas de la Semana Santa y del año litúrgico que junto con las del Jueves Santo, Viernes Santo y Domingo de Resurrección forman las celebraciones centrales del año. El Domingo de Ramos es un día alegre y triste a la vez. La liturgia del Domingo de Ramos comienza con la bendición de las palmas y ramas de olivo. El color de éste día es el rojo, que representa a Jesús como rey en su entrada triunfal en Jerusalén.

Viernes Santo

Es una de las principales celebraciones del Cristianismo, o sea de los seguidores de Cristo. Se recuerda la Muerte de Jesús. Por tradición se ha invitado a hacer penitencia, ayunos, y muchas cosas más. Pero aun no se ha mandado a vivir con FE este día! Vivelo con actos espirituales no materiales!

Recuerda que Jesús muere en la cruz para salvarnos del pecado y darnos la vida eterna, sin importar cuantos camarones o pescados te comas.

La vida es tan corta y el oficio de vivir tan difícil, que cuando uno empieza a aprenderlo, ya es tarde. Por qué es cuando empezamos a morir.

Jueves Santo

Con este día Triduo Pascual:

Jueves Santo, Viernes, Sabado Santo y Domingo

de Pascua. Se celebran los tres grandes misterios de la redención, La Pasión, Muerte y Resurrección de Jesucristo.

La Última Cena: Fue la última ocasión en la que Jesús de Nazaret se reunió con sus discípulos para compartir el pan y el vino antes de su muerte. Se considera que es el momento en que se instituye la eucaristía.

El lavatorio de los pies: Jesús nos enseña con su ejemplo a servir a los demás.

La noche en el huerto de los Olivos: Mc14, 32-42:

Te imaginas que sentía Jesús al saber que moriría? Miedo, angustia, tristeza por ser traicionado, soledad, su compromiso por cumplir la voluntad de Dios, su obediencia a Dios Padre y su confianza en Él? Jesús en este día nos quiere enseñar: La confianza y obediencia a Dios, la generosidad y la humildad.

Sábado Santo

El día en que Jesús "descansó" de su obra de proveer la salvación para el mundo. Es el día en que Jesús permaneció en la tumba donde había sido enterrado después de Su crucifixión, bajo a los infiernos (Mateo 27,59-60; Marcos 15:46, Lucas 23:53-54, Juan 19:39-42). En la vigilia Pascual contemplamos el mundo de oscuridad y celebramos la luz de la esperanza de la resurrección de Cristo.

La referencia bíblica de Mateo 27:62-66 nos dice la muerte y resurrección de Jesús sucedió el sábado. Después de la puesta del sol del sábado, al final del día de reposo - los sumos sacerdotes y fariseos fueron a Poncio Pilato y le pidieron que un guardia se colocara en la tumba de Jesús para evitar que sus discípulos sacaran y llevaran el cuerpo. Se acordaban de que Jesús dijo que resucitaría en tres días (Juan 2:19-21) y querían hacer todo lo posible para evitarlo. Sabemos de los siguientes relatos que los guardias romanos eran insuficientes para impedir la resurrección y los que regresaron a la tumba la mañana del domingo la encontraron vacía. **El VIVE!**

ConectarME

Cristo

CONSECRACION
Adoracion a Dios

CRECER

EMMAUS

En el

2013

Que

chuladad!

SOLO

FALTAS

TU!

Asistente de Liturgia
Lety F., Lupe, Magdalena

TECHNOLOGY
Amairani

DECORACION-ALTAR
Maribel, Esperanza C., Noemi O., Lety F., Maddalena, Lupe

OPRENDAS
Silvia, Trini H., Martha R., Jose Antonio

MUSICA
1. Matus
2. Rosalba & Margarito

Lectores
Lety S., Trini Sanchez, Silvia, Gina T, Lety F

Cooperativas
Edilberto, Eva, Alex, Lety, Graciela

CONVIVIO
Laura P., Gabriel

Clases de musica
1. Antelmo
2. Manuel, 2. Matus, 3. Margarito

INMIGRACION
Monse

PAN DEL CIELO
ANGELES: CARCEL, ENFERMOS
1. Jose A., Leticia S., Balvina

DANZA
1. Veronica, Trini, S. Esperanza

Fotografia
Balvina, Antelmo, Soledad

SOLO PARA MUJERES
1. Trini, Hernando
2. Gina T.

MUNDO MARAVILLOSO
1. Erika, 2. Trinidad, 3. Magdalena

CONFIRMACION
1. Lety

DOMINGO-JOVENES
1. Laura, 2. Nicole, 3. Veronica, 4. Rachael

COACH
1. Alex

G.E.D
Laura M., Karina, y Cristina

E.S.L
1. Soledad

1. Soledad

Lo fácil ya lo hice, lo difícil lo estoy haciendo lo imposible me tardare pero lograre.

Domingo de Resurrección

"Al tercer día resucitó", en esta piedra angular se basa la fe cristiana. El Señor de la vida había muerto, pero ahora vive y triunfa. Este es el día de la esperanza universal, el día en que en torno al resucitado, se unen y se asocian todos los sufrimientos humanos, las desilusiones, las humillaciones, las cruces, la dignidad humana violada, la vida humana no respetada. **En la Resurrección la vocación cristiana descubre su misión.**

No podemos perder jamás la esperanza en la victoria del bien sobre el mal. Por esta razón los cristianos con gran júbilo celebramos este día la Misa Pascual del Domingo de Resurrección.



Abril 21
Parejas del mismo sexo
 con desayuno!
 10:00am

Mayo 19
Parejas Heterosexuales
 con desayuno incluido
 10:00am cuidado de niños!

Comunicación en la Pareja

EMAUS Anuncios
 Servicios para la comunidad

- Emaus manos, mentes, y corazones abiertos!
- Clases personalizadas de ingles.
- G.E.D. Matemáticas escritura y lectura.
- COACH: Grupo de consejería de apoyo.
- CLASES DE MUSICA.
- Educando a nuestros hijos a vivir saludables: Taller de Gateway.
- Programas después de la escuela.

Servicios Eclesiásticos.

- Visitas a enfermos y presos.
- Bautizos, Regístrate para hacer tu CONFIRMACIÓN! 634-5515

DULGERIA LA CHAPIS
 1326 Douglas Av.
 262 634 8004

Mi Jacalito Restaurant

ESPERANZA BRIDAL BOTANICA
 262-637 4756
 622 HIGH ST.

SOYO'S RENTAL BRINCOLINES, MESAS Y MAS
 262 721 5093

Betty's Gift Store
 1400 Washington
 262 939 2854

PATROCINADORES



MISA DE SANACIÓN Y LIBERACIÓN

New! En Emaus Angeles Ministerio de enfermos y presos

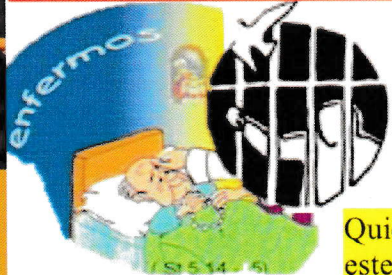

Quieres ser parte de este GRUPO? Sirvele a Dios!

Sabado Abril 27 a las 7:00pm
 No hay Misa el Domingo 28

Síguenos en **facebook**
 Parroquia Emaus (ELCA)

"Si pudiéramos saber primero en donde estamos y a donde nos dirigimos, podríamos juzgar mejor que hacer y como hacerlo." Abraham Lincoln.

Para recibir textos de informacion de la Parroquia y comunitarios: Regístrate mandando un texto al 414 8811403



Sera que el maltrato afecta a los niñ@s?

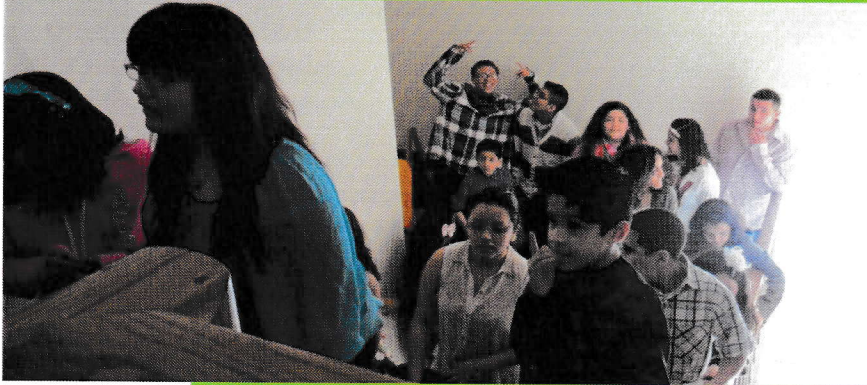

Emaus enseñando a los niños a PENSAR Y ACTUAR como líderes!

HISTORIA SOBRE EL DIA DEL(A) NIÑ@

En 1954, la Asamblea General de las Naciones Unidas recomendó que se instituyera en todos los países un Día Universal del Niño y niña.

Es un día consagrado a la **fraternidad** y a la **comprensión** para niños en el mundo. En este día se desea promover actividades para crear un mejor futuro para los niños.

En 1954, la Asamblea General de las Naciones Unidas recomendó que se instituyera en todos los países un Día Universal del Niño. La ONU celebra dicho día el 20 de noviembre, en conmemoración a la aprobación de la Declaración de los Derechos del Niño en 1959 y de la Convención sobre los Derechos del Niño en 1989.

En México se celebra el 30 de Abril. Los padres entregan un

presente a los niños. Las escuelas realizan actividades para conmemorar el día (festivales, salidas, talleres educativos, etc). **Sera que un solo dia es suficiente para hacer esto? Si tu respuesta es no! A partir de hoy que vas a querer promover en tu comunidad. En las escuelas? Barrio? Parroquia? Etc...**

Derechos del niñ@
La mayoría de países han ido consagrando medidas especiales para la protección, a nivel legislativo e incluso derechos constitucionales, de los niños. Entre los Derechos del

niño destacan los siguientes: A la vida. A la salud. **Al descanso**, a la recreación, el juego, la creatividad y las actividades recreativas. A la libertad de expresión y a compartir sus puntos de vista con otros. A un nombre y una nacionalidad. A una familia. A la protección durante los conflictos armados. A la libertad de pensamiento, conciencia y religión. **A la protección contra el descuido o trato negligente.** A la protección contra el trabajo infantil y contra la explotación económica en general. A la educación, que será gratuita y obligatoria por lo menos en las etapas elementales.

EL CONOCIMIENTO QUE NO SE COMPARTE NO SIRVE (G.E.D, tutora Carina)

Trabajar con adultos que quieren prepararse para obtener el G.E.D ha sido una experiencia que emociona y satisface mis necesidades personales. Yo no me imagino mi vida sin compartir lo que se. Es como ser un carro y no servir para transportar a personas, te imaginas? O ser comida, solo para verla y no poder disfrutarla.

No solamente compartimos conocimientos matemáticos, sino personalidades, experiencias con un propósito claro y es el de superarnos. Superarnos?

Si es para tener mejores trabajos, oportunidades que nos ayudaran a vivir una mejor vida.

Los niños tienen tanto que enseñar. Su amor es incondicional. Son frágiles, tiernos. Aunque tengan hambre, miedo, ellos son felices. Cuando has visto a un niños preocupándose por el mañana?

Disfruta el hoy al máximo (Soledad)

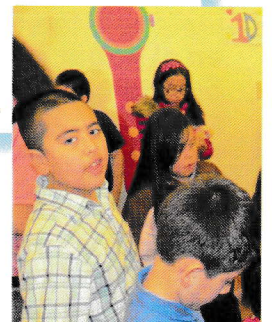

Concepto de Violencia familiar

Son innumerables las formas de violencia familiar. Hace unas semanas condenaron a una mujer por dejar a sus hijos solos en casa, encerrados en un cuarto para ella ir a trabajar, Los niños murieron. Esa no era la primera vez que esta y otros padres hacen eso.

La violencia puede ser mental o física, y ocurre en todas las clases sociales, culturas y edades. La relación de abuso es aquella en la que una de las partes ocasiona un daño físico y/o psicológico a otro miembro. Este daño se puede dar ya sea por acción o simplemente por no hacer nada que detenga dicha violencia. Y eres tan culpable si tu eres quien da el maltrato o si te quedas callad@.

Maltrata a tus niños? Los niñ@s son vulnerabilidad. O sea, los menores tienen inferiores recursos para defenderse de lo que les puede hacer un adulto. Además se debe considerar el daño emocional y los efectos a corto y largo plazo que provocan los maltratos. Como adulto, no llevas una herida en tu corazón por aquellas palabras que se quedaron grabadas.. "no sirves para nada," nunca haces nada bien.."

En muchos casos el maltrato es como una cadena, se trata de golpeadores que fueron maltratados en su propia infancia (56.7% de los casos totales, debemos aclarar que según los psicólogos eso no ocurre de este modo necesariamente).

Crees que tu castigo es justo? Muchos padres perciben como justos los castigos implementados, o perciben la desproporción del castigo ofrecido con las supuestas faltas cometidas, que se justifica de alguna manera. Alguno para justificar su maltrato dicen; "es por mis nervios, el stress, la pobreza, etc.

Cómo se siente un niño cuando existe violencia familiar/peleas en la familia o en el hogar?

Sera que la rebeldía, sus enojados, miedos, depresión, pena, tristeza, poco rendimiento en la escuela, inseguridad, la poca capacidad de relacionarse con otros tendrá que ver algo con nuestro trato hacia ellos?

Los niños también tienen sentimientos.



LIDERAZGO

Al SERVIR no se trata de impresionar sino de amar. No se trata de activismo sino de ser dócil a la voluntad de Dios!

EXACTAMENTE eso es lo que buscamos algunos líderes religiosos en Racine. En Marzo comenzamos a escribir un nuevo capítulo en la historia de Racine. La gran pregunta que nos hacemos líderes religiosos como el Pr. Anthony (Pastor de Cristo Rey y St. Patricio), Pr. Jhon Freddy, Abigail (Judía), y Michael M. (organizador comunitario) es **COMO PODEMOS SERVIR A LOS HIJOS E HIJAS DE DIOS?** Ayúdanos a encontrar maneras de cómo podremos vivir el legado, el mandato, la invitación de nuestro Señor y Salvador Jesucristo!

Es necesario entregar a nuestros pequeños un mundo mejor que el que nos entregaron a nosotros. Que estas dispuest@ a hacer? Que obstáculos tenemos en medio que nos impedirán avanzar para construir un mejor futuro?

Tus hijos son pobres o Ricos?

basada en el Libro de Cuauhtémoc: Enseñando a los niños a Pensar y actuar...

(Reflexión)

“La riqueza

es un estado del alma, producto de la educación del carácter. Los niños pobres son perezosos, no se esfuerzan, no respetan horarios, odian estudiar, y exigen diversión día y noche. Creen que merecen todo, son exigentes y groseros, siempre obtienen lo que quieren llorando o fingiendo que están enojados.”



Sus papas “preocupados” supuestamente, los miman y les dan lo que piden. Los niños pobres no conocen el valor de las cosas. Tienen muchos juguetes con los que NI juegan, son descuidados y destructores; no saben ahorrar, nada les causa ilusión. Aparentan ser mas ricos que los demás y mostrando lo que tienen actuando con pretensión de grandeza.

EN CAMBIO Los niños ricos tienen un carácter forjado en el esfuerzo, saben que la vida implica un proceso de sembrar y cosechar, que la inspiración solo llega con la perseverancia. Que no basta con estirar la mano y gritar: “dame, dame,” para obtener algo. Todo tiene un precio, y la única manera de pagarlo es trabajando. Los niños ricos son tenaces, tienen un carácter de lucha, les gusta caminar, ejercitarse, esforzarse. Disfrutan creando. Tienen pocos juguetes, pero aprecian los que tienen, los cuidan, los organizan, son creativos con ellos, se sacan el máximo provecho, esperan los niños ricos ahorran dinero para comprar lo que les ilusiona. “Solo educando el carácter de los niños podremos brindarles una riqueza real!”



Carta de un Hijo a sus Padres Separados

Los amo con todo mi corazón, para mi son los mejores padres del mundo. La separación ha causado un gran dolor y me niega la oportunidad de crecer, aprender, conocer sobre la vida con las dos personas mas importantes de mi vida estando todos bajo el mismo techo.

Hoy tengo que aprender a vivir con los dos, pero cada uno llevando una vida separada. Les pido que no llenen mis vacíos y sanen mi dolor con regalos y diversiones, estos no reparan las heridas que han causado en mi corazón. Las heridas se sanan con besos, con abrazos y teniendo la certeza que ninguno de los dos me abandonara, pasen mucho tiempo conmigo, compartan las pequeñas cosas de la vida, ya que aun me tienes con vida.

Solo quiero que me sigan amando y que me digan con sus palabras y sus actos que soy importante para ustedes. Escúchenme y dejen que exprese mis sentimientos y preocupaciones sobre lo que esta pasando en casa. A veces siento tristeza, a veces tengo miedo de perderlos, otras veces siento rabia e impotencia de no poder hacer algo para que estén juntos. Pónganse de acuerdo en la forma como me van a educar, en las normas, y limites, esto me hará mas seguro. Recuerden que ustedes ya han vivido y han tenido la oportunidad de ser felices con lo que Dios les ha dado y yo apenas comienzo. De verdad eres feliz mama? Papa? Ayúdame a encontrar el camino para alcanzar mi felicidad.

No me culpen por querer verlos juntos nuevamente, por querer que mi familia sea restaurada y que haya un nuevo comienzo. Pero entiendo que ambos deben cambiar, no gritarse, no golpearse; y a lo mejor alguno de ustedes no lo quiere hacer. Te entiendo mama/papa!

No quiero ser espectador de nuevos conflictos, ni mensajero de sus recados. si me involucran me hacen daño porque me obligan a tomar partido y a tratar de darle solución a un problema que es de ustedes dos y no tengo ni la madurez, ni la capacidad para poderlo resolver.

El dolor de la separación es muy grande, no traten en perjudicarse mas, pues no solo se lastiman ustedes sino que me lastiman a mi también. Vivan y dejen vivir! Respéctense! Así piensen totalmente diferente. No se disputen quien se queda conmigo....los necesito a los dos. necesito de los cuidados y la ternura de mi mamita, y necesito de la seguridad, el amor, la protección que pueda darme mi papito. No me pidan que les cuente detalles de la vida de mamita o papito, me siento mal, me siento desleal cuando me siento forzado a decirlo. Jamás me hables mal de lo malo que fue papito o mamita, así sea verdad, resientes mi corazón y dañas la imagen de lo mas sagrado que me ha dado Dios - mis padres. Si no pueden amarse como esposos, ámense con el amor de Dios, bríndese respeto, comprensión, apoyo. Trátense sin envidias, sin dolor, sin egoísmo, sin rencor, sin orgullo. Sean sinceros, justos, y bríndese cariño y admiración. a pesar de la distancia entre ustedes, el amor jamás dejara de existir, prueba de ese amor eterno soy yo...

Si tu estas leyendo esta historia no es casualidad: escucha con atención, es Dios quien te habla a tu corazón: Búscame

QUE APRENDISTE DE LA SEMANA

SANTA?> Es considerada como el momento más importante de todo el año. Sin embargo, para muchos es como una semana mas. Se olvidan de lo esencial: es un tiempo para orar y reflexionar en que sentido-significado tiene para mi la Pasión-sufrimiento, Muerte y resurrección de Jesús?

La Parroquia Emaus intento este año 2013 con "*Jesús comiendo la ultima cena en México*" invitar a sus fieles a vivir de un modo más sensible toda la riqueza de las celebraciones propias de este tiempo litúrgico.

Lo importante de este tiempo no es el recordar con tristeza lo que Cristo padeció, sino entender por qué murió y aun mas importante es que resucitó. Es celebrar su entrega a la muerte por amor a nosotros y el poder de su Resurrección, que es nuestra resurrección a una mejor vida aquí en la tierra.

Para el 2014 el Domingo de Ramos recuerda celebrar la entrada triunfal de Jesús, en la que todo el pueblo lo alaba como rey con cantos y palmas. Aquí en Racine lo hicimos en el 2013. El es nuestro Rey, o sea el es quien gobierna en nuestras vidas. El es el encargado de que en nuestra vida todo salga bien.

El Jueves Santo que GRAN día! recordamos a Jesús con sus amigas y amigos cenando, sirviéndoles, lavando sus pies, dándonos un ejemplo de servicio. Tu aprendiste eso? A SERVIR? En la Última Cena: Creemos que Jesús instituye la Eucaristía. En Emaus el lavatorio de los pies y manos tomo un significado de compromiso de caminar juntos padre con hijos, esposo con esposa, amigos! Gracias Emaus por demostrar tu compromiso, por ser una familia!

Como olvidar lo que sucedió el Viernes Santo: La Pasión-sufrimiento de Nuestro Señor, su prisión, los interrogatorios; la flagelación, la coronación de espinas y la crucifixión. Las palabras de una abuelita de 76 años diciendo: "**es la mejor celebración que he vivido en toda mi vida, y quiero que sepas que tengo 767 años!**"

Hayyyy Domingo de Resurrección el día más importante de la Cristiandad. Nos vestimos de gala- Jesús venció a la muerte y nos DA VIDA. Esto quiere decir que Cristo nos SALVO!

Prepárate para vivir la súper experiencia de PENTECOSTES!

Que significa PENTECOSTES?

ACTIVIDADES

ABRIL

+ Sábado 27 de Abril Misa de **SANACION** 7:00pm. DOMINGO 28 No hay misa.

Mayo MES de la MUJER en Emaus!

- ~ Mayo 3-5 **RETIRO** de Superación personal. Salida Viernes 5:00pm
- ~ Mayo 5 – **Niñas- Bendición y consagración** de bebés – 16 años .
- ~ Mayo 12 **DIA DE LAS MADRES** (Una ceremonia especial dando honor, con testimonios.... No te lo puedes perder!).
- ~ Mayo 18 **Fiesta MEXICANA** de 11-5pm. Todo lo que quieras comer por \$8, música, rifas de \$500, mini iPod, y muchos mas!!!!
- ~ Mayo 19 **Pentecostés. Bendición a los vientres** de aquellas mujeres que piden a Dios ser madres.
- ~ Mayo 26 **Es por ti mujer!** (Una ceremonia especial dando honor, con testimonios.... No te lo puedes perder!).

~ Junio 2: **CUARTO ANIVERSARIO DE EMAUS!!!!**

EMAUS

Servicios para la comunidad

- Drogadictos, prostitutas, adictos, alcohólicos, santos, TODOS somos bienvenidos a Emaus!
- Clases personalizadas de inglés.
- G.E.D.: Matemáticas, cultura y lecturas.
- COACH: Grupo de consejería de apoyo.
- CLASES DE MUSICA.
- Programas después de la escuela.

Servicios Eclesiásticos

- Visitas a enfermos y presos. - Bautizos, quinceañeras, bodas, y mas!

Regístrate para hacer tu **CONFIRMACION!**
634-5515

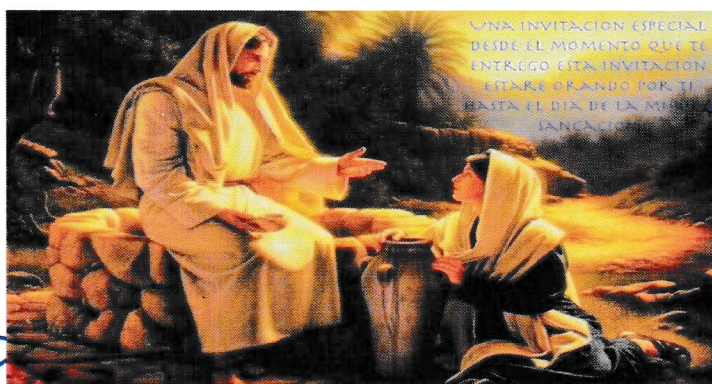

MISA DE SANACION Y LIBERACION

Sabado Abril 27 a las 7:00pm
No hay Misa el Domingo 28

Quieres hacer servicio comunitario y ganar creditos para tu escuela?

Mi Jacalito
Restaurant
262 633 8633

DULCERIA LA CHAPIS
1326 Douglas Av.
262 634 8004

SOTO'S RENTAL
BRINGOLINES, MESAS Y MAS!!!
262 721 5093

ESPERANZA BRIDAL BOTANICA
262-637 4756
622 HIGH ST.

Sonido Pantera
cualquier evento llama ya!
262 412 6919

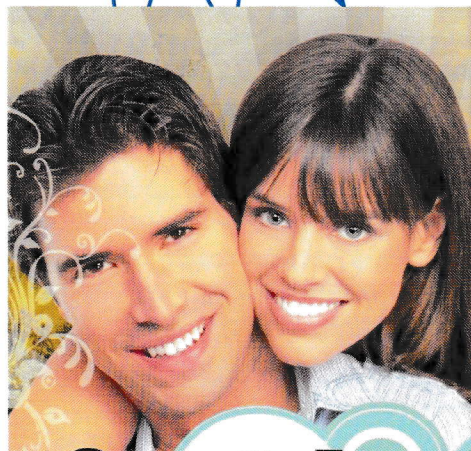

Abril 21
Parejas del mismo sexo
con desayuno!
10:00am

Mayo 19
Parejas Heterosexuales
con desayuno incluido
10:00am cuidado de niños!

Retiro DE LIDERAZGO
Parroquia Emaus
3, 4 & 5 de Mayo
Salida Viernes 5:00pm
TODOS disponemos de un potencial interno y extraordinario que nos permite desarrollarnos interna y externamente.

New! En Emaus Angeles
Ministerio de enfermos y



Quieres ser parte de este

GRUPO?

Para recibir textos de informacion de la Parroquia y comunitarios: Regístrate mandando un texto al 414 8811403

Comunicación en la Pareja

Síguenos en **facebook.**

Parroquia Emaus (ELCA)



Emaus en el 4 aniversario se va de paseo.



Junio 2 Paseo familiar – no Habrá misa en Emaus
Salida 7:15am de Emaus. La misa será en el lago
donde iremos hacia Burlington. Regreso 6:00pm
Costo \$10 x adulto \$5 niños

EMAUS

Somos Uno Solo

Felicidades Emaus en tu
4 aniversario!

Una sola raza,
un solo pueblo,
con un solo
estandarte,
una sola
vision:
Esperanza,
respeto,
tolerancia,
Y ante todo
AMOR!!!



Haz sido victima de tickets y mas tickets? Si aun no haz sido- que pensarías si te detienen, te dan un ticket y luego otro y otro por no tener licencia y algunos dicen que simplemente por ser Mexicano?

Esta es nuestra hora... ven únete, juntemos mil personas, demostremos que la unión hace la fuerza, creemos presión política, para que todos construyamos una mejor Racine. Confiamos que el alcalde, el jefe de la policía, y claro esta el anfitrión es el Jefe de los Sheriff. Ven tu presencia hará la diferencia. Se buscan historia de abusos de parte de Sheriff Y de Familias divididas por las deportaciones. **UNETE!**

LUNES JUNIO 10 @ 5:45 PM
en La Parroquia Emaus (ELCA)



Cual será el FUTURO?

Llevamos mas de dos años mirando la manera de como trabajar juntos con otras 5 iglesias. A este grupo se le ha llamado FEesACCION. Hemos avanzado, aunque parecería que a pasos de Tortuga, me han recordado que debemos confiar en Dios quien es el que esta a cargo. Se acaba de pedir una beca de \$100,000 (si con lo que podemos comprar 5 casas en la economía de hoy) con la meta de traer personas que nos ayuden a seguir vislumbrando un mejor futuro. Se desea contratar a un trabajador profesional para desarrollar una misión con la juventud, al igual a una mujer de la comunidad de Racine Susan G quien ha ayudado a realizar grandes proyectos en la comunidad. Cual es tu misión en esto? Orar, unirte, responder al llamado que Dios te hace ha participar de algunos eventos, asegurarte que tu voz y la de tu familia tenga voto. Y aun mas importante darnos tus sugerencias. Que crees que debemos hacer las 5 iglesias juntas? Cual es tu propuesta? Escríbela- jhoncorrea@hotmail.com, textea la 414 881 1403 o llama 262 634 5515 **haz oír tu voz!**



Pentecostés?

Es 50 días después de la Fiesta de

Primeros Frutos. Se celebraba la fiesta de Shavuot o semanas en hebreo, llamada en griego Pentecostés, (Cincuenta días) ordenada por Dios (lee levítico 23:15-21). Hay dos diferentes días de primeros frutos en la Palabra de Dios. El primer día de los primeros frutos o primicias, es el primer día de la semana después de la Pascua que se celebra el día 14 de Nisan de acuerdo a lo ordenado por Dios (Lev 23: 9-14). En este día se debía presentar al sacerdote una gavilla de los primeros frutos de la cosecha. Este fue el día que Jesús resucitó, y fue al Padre a presentar su preciosa ofrenda. (Jn. 20:17). Y es a partir de este día en que de acuerdo a Lev. 23: 15 se deben contar los cincuenta días (vs. 16). Esta cuenta se llama la cuenta del omer. Un omer es una medida para granos secos, según lo descrito en Oseas 3:2. Durante cada día de este periodo, la tradición Hebrea es orar y agradecer a Dios por la provisión del año, así como recoger la ofrenda que será presentada al final de los cincuenta días, como ofrenda de los primeros frutos del año. **Y tu eres agradecid@ con Dios por todo lo que te ha dado? De que manera podrían los demás decir que tu eres agradecid@ con Dios?**

La fiesta de Pentecostés es una fiesta de alegría y gratitud, así como de confianza en el Señor de que será nuestro proveedor. **Cual te falta?**

Alegría- gratitud y confianza?

TAREA: - Haz una lista de las cosas por las cuales estas agradecido/a, lo que te da alegría y entrégala en la ofrenda a Dios en misa.

- Confías en Dios? Por que dudas? No crees en sus promesas?



Hemos celebrado Pentecostés la gran fiesta en la cual pedimos la presencia consoladora, la presencia que nos guía y desafía a todo creyente cristiano a una vida abundante, si, la presencia del Espíritu Santo. Es ese soplo impetuoso, soplo divino que describe el autor de los Hechos, es capaz de transformar nuestras vidas para así aspirar a ser mejores seres humanos.

El Espíritu prometido por nuestro Señor Jesús cada día se hace su presencia más necesaria en nuestro diario vivir. Esta experiencia del Espíritu Santo es una práctica que se vive en comunidad. La compartimos en nuestro entorno cotidiano para que los que están a nuestro lado se contagien con el gozo de la vida plena que nos infunde esta presencia.

Sabemos que las dificultades y tropiezos nos acechan cada día y es por eso que la presencia del paracleto es imprescindible para subsanar y sobreponernos a los retos que experimentamos en el mundo del siglo 21.

Podríamos decir que celebrar Pentecostés es **crear un espacio para abrazar la gracia de Dios en nuestras vidas**. La energía de esta fiesta nos "carga las pilas" para continuar nuestra peregrinación en nuestra vida diaria y por venir.

Celebrar Pentecostés no tan solo es la experiencia personal sino también comunitaria. Es celebrar la diversidad étnica y lingüística que Dios ha creado. Este pluralismo nos reta a buscar nuevas formas de convivencia en paz y **unirnos como un solo pueblo de Dios**. Sin duda, esta es nuestra esperanza manifestada en Pentecostés.

Att: Rev. Héctor Carrasquillo

Director Ministerios Latinos, Unidad Multicultural de la ELCA

Para reflexionar...

Da amor y amor recibirás

Tal vez esto te pasa a ti o alguien muy cerca de ti...

Fue una vez un muchacho, el primero en todo, mejor atleta, mejor estudiante, pero lo que nunca supo fue si era un buen hijo, un buen compañero o un buen amigo. En un día de depresión el muchacho se dejó morir. Cuando iba camino al cielo se encontró con un ángel y este le preguntó: "¿Por qué lo hiciste? si sabias que te querían...", a lo que El respondió: "hay veces que vale más una sola palabra de consuelo que todo lo que se sienta... en tanto tiempo nunca escuché: estoy orgulloso de tí... gracias por ser mi amigo... ni siquiera un te quiero mucho..."

Al quedar pensativo el ángel, el muchacho añadió: y sabes que es lo mas que me duele?", el ángel triste le pregunta: qué?, a lo que él responde: "que todavía espero oírlo algún día..."

Luego de esto el ángel abrazó al muchacho y le dice que no se preocupe por que se acerca a la única persona que siempre le dijo al oído que lo amaba pero él nunca lo escucho, pero lo espera con los brazos abiertos...

Moraleja:

Nunca pierdas la oportunidad de decirle a alguien lo importante que es para tí o pudiera ser demasiado tarde...

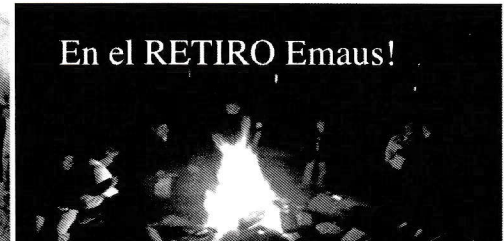



Sabias el origen de la celebracion sobre las madres?

Las primeras celebraciones se remontan a la antigua Grecia, donde se le rendían honores a Rea, la madre de los dioses Zeus, Poseidón y Hades.

Igualmente los romanos llamaron a esta celebración Hilaria cuando la adquirieron

de los griegos. Se celebraba el 15 de marzo en el templo de Cibeles y durante tres días se realizaban ofrendas. **Si ese era el origen de dar tres ofrendas, cunatos regalos le has dado a las mujeres que tanto amas este mes?**

En Inglaterra hace muchos años niños iban a misa y regresaban a sus hogares con regalos para sus progenitoras. **Y hoy que hacemos en las iglesias para las mujeres?** En ese tiempo muchas personas trabajaban y no tenían la oportunidad de estar en sus hogares, el Domingo-día de la celebracion de las madres- se le daba el día libre para visitar a sus familias.

En 1870 la activista Julia Ward Howe escribió un apasionado llamado a la paz y al desarme. De todos modos, en 1873, mujeres en 18 ciudades estadounidenses realizaron una reunión del Día de las Madres. Boston lo siguió celebrando durante al menos una década más. Al paso de los años, siguió aumentando los festejos. Howe continuó trabajando por otras vías por los derechos de las mujeres y por la paz. El 12 de mayo de 1907 Ana Jervis dos años después de la muerte de su madre, quiso conmemorar el fallecimiento y organizó un día de la madre para hacerlo. Finalmente, siete años después el presidente Woodrow Wilson declaró en el año 1914, el Día de la Madre como el segundo domingo de mayo en Estados Unidos. Así fue gestado el día internacional de la madre que después fue encontrando eco en otros países que lo adoptaron hasta tenerse la celebración conocida en la actualidad.

Conociendo al CORO?



Cuando José Antonio canta en la iglesia el dice **“siento paz, emoción, pero sobre todo el poder de Dios sobre mi”** Desde que estoy en la iglesia, personas que me conocen de cerca me han dicho que me admiran porque he han notado un cambio muy grande..” mi cualidad mas grande es ser útil, ayudar a la comunidad.

Que es? Que ha hecho en mi vida? Porque estoy en coach?

Coach es alguien que camina junto a ti ayudándote a descubrir que quiere Dios para ti, y te ayuda hacerlo!

Un coach esta contigo. Te ayuda a ubicarte donde TU estas en este momento de tu vida y a donde quieres llegar. Te ayuda a busca y clarificar la visión de lo que quieres para tu vida y como lograrlo. Es algo tan sencillo pero que ayuda tanto. Lo hace con preguntas (abiertas no cerradas, que te llevan a pensar cosas que nunca se te habían pasado por tu cabeza); el coach no te da las respuestas, porqué las respuestas nosotros las tenemos! Nos ayuda a encontrarlas!

Cuando empecé a practicar “coach” en mi vida, me ayudo a darme cuenta que por muchos años fui esclava de mis propia ideas y “negatividades” que yo misma construí.

Estoy aprendiendo que tengo tanto a mi alrededor con lo que cuento para solucionar tantas cosas que antes no sabia, ni creía, poder hacerlo. Hoy gracias al programa de coach tengo una mejor visión de mi vida, de lo que quiero, y de lo que es mas importante para mi. También he encontrado maneras y hoy puedo tener una mejor relación con mi hija . Me ha servido para **reflexionar, enfocar y formar un plan** en mi vida de lo que quiero seguir logrando. Estoy en coach porqué quiero seguir conociendo mas de mi, seguir teniendo mas herramientas para vencer mis obstáculos. Con la ayuda de coach, no tengo duda, puedo y estoy segura que lograre mis metas y seré lo que siempre soñé: ser una persona de éxito.

Sabemos que Dios nos tiene en este mudo, donde muchos nos preguntamos: cual es nuestra misión?

Yo te quiero invitar a que la encuentres y encuéntrate contigo en coach!

Exígele al Pr. Jhon Freddy que tu quieres ser parte de coach.

Atentamente Soledad Beltrán





Acti iDADES



Regístrate **GRATIS** si es **FREE!** Cupos limitados.

Será desde July 1-30 * horario: 8:30-2:30pm

* **Campamento de VERANO GRATIS:** Niños de 6-11 años

** **Campamento de Jóvenes SALT** desde 11-16 años: Realizaran trabajo comunitarios, como pintar casas, limpiar la ciudad, visitar abuelitos, mucho mas, **Y DIVERSION!!!!**

Grupo solo para mujeres!

Quieres recibir bendiciones en tu hogar? Que tal abriendo las puertas de tu casa para el **estudio bíblico?**

Charla comunitaria con el JEFE de los Sheriff, jefe de la policía, el alcalde y otros lideres comunitarios!



WOW!
En el verano MATC
trae 2 profesores de
Matemáticas



Gracias a Carina, Laura por su compromiso y entrega a la educación. Gracias también a Cristina, Soledad, Noemí y Maribel quienes han sido motores para que este gran proyecto siga adelante! Gracias especiales a los estudiantes que han sido fieles a un mejor futuro!

Gracias MATC!!!

Felicitaciones a los lideres que han decidido hacer la diferencia



El retiro: Las personas que participaron aparte de reír como yo no lo había hecho en los últimos 4 años, aprendimos demasiado, trazamos metas personales, familiares y estamos comprometidos a luchar por esas metas.

En el retiro nos dimos cuenta, la vida es muy corta y debemos vivirla con sentido!



ASEGURA
INSURANCE AND FINANCIAL SERVICES
Mario Martinez Agency, Inc.

- Auto • Home • Business
- Medicare Solutions

RACINE: Mario Martinez
(262) 456-0321

KENOSHA: Adriana Neave
(262) 496-0180

Dios tiene una misión y TU y yo somos parte de esa gran misión!!! Gracias a TOD@s los que hicieron parte de la actividad

Fiesta Mexicana este mes!

para recaudar fondos para tu comunidad!



Signenos en

facebook
Parroquia Emaus (ELC)

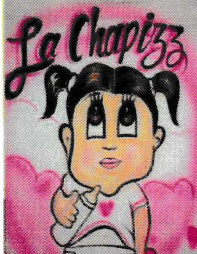

DULGERIA

LA CHAPIS

1326 Douglas Av

262 634 8004

Funeraria
Strouf

Sirviendo a la comunidad en los momentos mas difíciles!

1001 High St. Racine 262-632 5101

Mi Jacalito
Mi Jacalito Restaurant
Restaurant

262 633-8633

Emaus

1925 Summit Av. Racine

262 634 5515 Ext. 12

Facebook: Parroquia Emaus (ELCA)

Orgullo de Racine!

El grupo de Danza de Emaus lleno las calles de Racine de colores y alegría con su participación en el "Parade del 4 de Julio 2013"



El campamento de verano 2013

Es orgullo de Racine! Sirviendo a mas de 80 niños:

Desayuno, almuerzo y 2 snacks saludables que incluyen frutas y vegetales. Ene l campamento los niños leen, aprenden historias, ciencias, de Dios y mucho mas!!!

Los niños (5-11 años) y el grupo SALT (jóvenes de 11-16 años que significa Sirviendo y aprendiendo juntos) traen regalos tan hermosos a nuestra comunidad! Gracias a ellos, a los voluntarios y trabajadores que han hecho que este programa sino es el mejor sea uno de los mejores de Racine hasta este momento! Que orgullo!!!

El programa terminará el 1 de Agosto. Después de reunirse todos los días (de Lunes a Jueves) de 8:30-3:00pm! Gracias! Gracias!!

Necesitamos enviar una delegación en Agosto 9, 10 & 11 a Chicago a representar nuestra Parroquia.

•hotel, comida, transporte. Todo PAGO. Te animas!!!

Felicitaciones!



Estudiantes GED

orgullo de Racine

que han pasado mas de un examen ya!!!

Y muchos otros que no tenemos sus fotos ya pasaron también!



El verano es una época donde cambiamos con frecuencia de lugar de residencia y de actividad. Esto unido al cambio de clima, de comidas y ambiente convierten al verano en una época especial, llena de diversiony descanso, pero también con riesgos nuevos ante los que debemos tomar precauciones para sacar un diez en salud.

1. Cuídate del sol y el calor
2. Mantente hidratado
3. Cuida tu alimentación
4. Guarda la digestión.
5. Cuídate de las picaduras
6. Cuida tus oídos
7. Cuídate de los hongos
8. Usa la ropa y calzado adecuados
9. Extrema la vigilancia de los niños en playas y piscinas
10. Extrema las precauciones en carretera



Viviendo MEJOR?

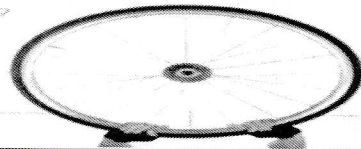

Lograr el balance entre lo que es nuestra vida personal y el trabajo que a veces es tan difícil. Hoy, quiero compartir contigo **siete consejos** para mejorar el balance entre vida y trabajo.

Organízate. Debes programarte adecuadamente. **Se flexible.** **Ejercítate,** esto te ayudara a mejorar la energía diaria. **Maximiza los viajes.** Aprovecha el tiempo que tienes disponible y disfruta con tu familia. **Vacaciones de facebook, texts, y llamadas.** Déjales saber a todos que no estás disponible. **Habla con Dios.** Puedes comunicarte de diferentes maneras: una canción, un poema, viendo la naturaleza, escucha a Dios! **Desconéctate.** Al hacerlo y regresar al trabajo te darás cuenta que la vida ha continuado

Implementa estos consejos y te retes a desarrollar un balance entre vida y trabajo. ¡No te arrepentirás! Te prometo que te sentirás mejor.

Que tan balanceada esta TU VIDA?

Acuérdate que tu si puedes lograr todas tus metas!

Calificate! Cada vez que escuches una área de tu vida, califica tu nivel de satisfacción mediante una escala del 0 al 10. Siendo el 0 el más bajo y el 10 el más alto nivel de satisfacción. Y así podrás identificar esa parte de tu vida que esta desbalanceada y empieces a tomar pasos positivos para equilibrarte.

Los 8 elementos son: **Trabajo, dinero, salud, pareja, familia y amigos, diversión, crecimiento personal, espiritualidad.**

Te pregunto, tu **Trabajo** te satisface? Ganas suficiente **Dinero**? Para sentirte exitoso tienes que estar en el lugar adecuado, rodeado de personas que te apoyen a superarte en tu labor.

Los otros dos elementos son la **Salud** y la **Diversión.** Estas prestándole atención a tu salud? Que haces para divertirte? la diversión es saludable y te hará sentir bien, por eso no puedes ignorarla.

La **Pareja, Familia y Amigos** nos hacen reflexionar sobre las relaciones. Te llevas bien con tu pareja? Con tus familiares, tus hijos? Si hay conflictos en este aspecto, hay un desbalance. Estas situaciones pegan al corazón y son las que más duelen. El perdón es necesario para sanar las heridas, pero se tiene que perdonar de corazón.

Los dos últimos elementos son la **Espiritualidad** y **crecimiento personal**; Estas conectado con tu fuente espiritual? Tomas tiempo para disfrutar de la naturaleza? Para poder lograr una espiritualidad más profunda y crear un entorno placentero, es necesaria la meditación diaria y así encontrar la paz interior y llegar a entender lo que es el Amor verdadero. Lees? Que lees? Participas de talleres a menudo? Amigos ahora que saben lo que es la rueda del balance, **empiecen a hacer cambios positivos.** Al final de la jornada, lo que cuenta es la linda energía que irradies al vivir una vida equilibrada. Eso te traerá muchas bendiciones, y te dará el poder de tener el control de tu destino para que seas feliz. **Recuerda Dios tiene el control!** Tú puedes lograr todo lo que te propongas, así que dale a lograr el balance en tu vida, te estaré esperando para que juntos celebremos la victoria!

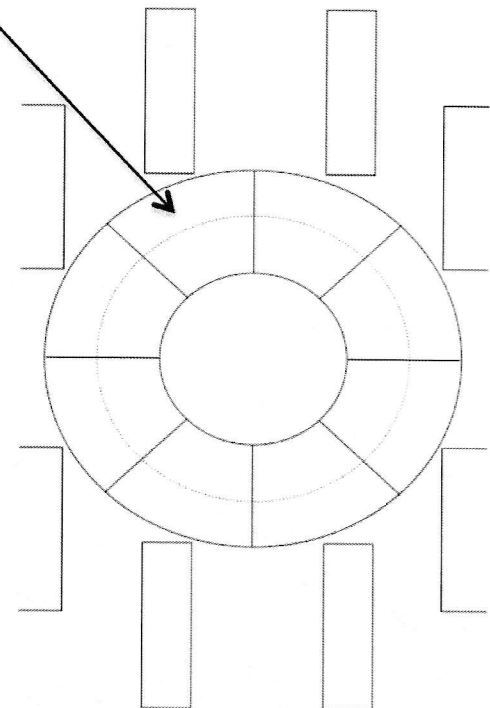

Luce tu rueda así???

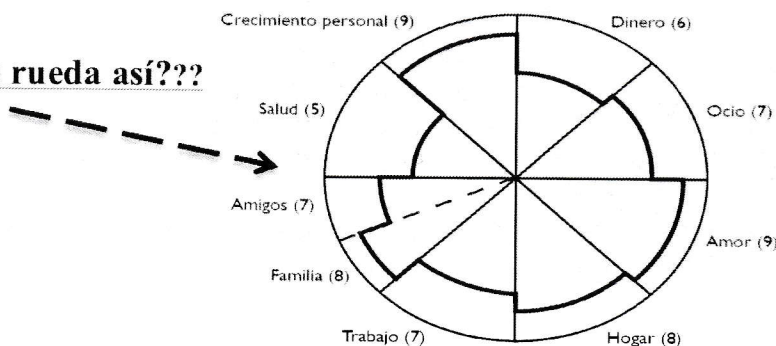

Edúcate! Para que puedas **EDUCAR** a otros sobre inmigración!

Immigration Myths Busted

VERDAD



Lutheran Immigration and Refugee Service

myth
Most immigrants are here illegally.

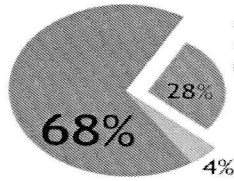

citizens or legal residents
legal temporary workers
undocumented

40.2 million immigrants in the U.S.

72% of immigrants are in the U.S. legally.¹

myth
Immigrants take jobs away from U.S. citizens.

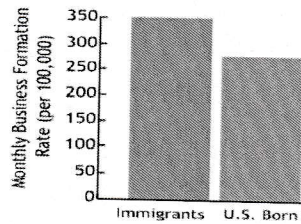

Immigrants at all skill levels actually **create job opportunities.**

Immigrants are **30%** more likely than U.S.-born citizens to form new businesses.

myth
Immigrants drain resources without contributing economically or paying taxes.

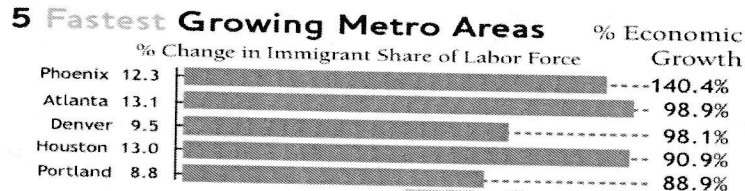

Immigrants have played a central role in the cycle of economic rebirth of U.S. cities.

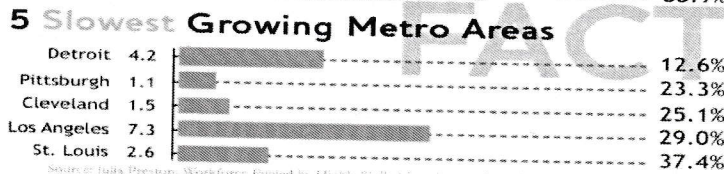

Source: Julia Preston, 'Workforce: Eased by Highly Skilled Immigrants' (New York Times, April 18, 2010)

Taxes paid by both legal and undocumented immigrants exceed the costs of the services these migrants utilize.

myth
Immigrants increase crime.

Incarceration rate, California, 2000

(highest population of immigrants, undocumented and legal)

4.5% native-born
0.7% immigrant

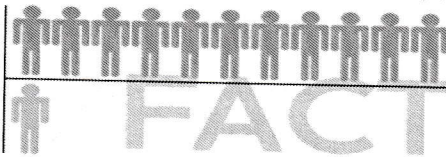

Men age 18-39 (vast majority of U.S. prison population) that are native-born are

11 times more likely to be in prison than immigrants.

From 1994 to 2005 nationally the undocumented population **doubled** while the rate of violent crime declined by **34.2%**



Retiro Espiritual juvenil

Paseo de Canoas con las 5 iglesias – Domingo 26 de Julio 1:00pm
Reitro Juvenil con la iglesia de Milwaukee Viernes 26 de Julio-Domingo 28.

Festival VIVA LA FIESTA Septiembre 7 & 8

Que dice la BIBLIA sobre como balancear mi vida!

Creer es necesario en todas las áreas de la vida: negocios, educación, finanzas, y especialmente en nuestras vidas como hijos de Dios: Lee: **Efesios 4:14-15; 1 Pedro 2:2; 2 Pedro 3:18; 2 Tesalonicenses 1:3** "Vivan la vida con el debido sentido de responsabilidad, no como aquellos que no conocen el significado de la vida, sino como aquellos que lo conocen," dice **Efesios 5:15**. **No permitan que los errores de la gente mala los conduzcan por el camino errado y les hagan perder el balance, dice 2 Pedro 3:17.**

Cuales son los OBSTÁCULOS PARA CRECER?

- 1. CARENCIA DE ESFUERZO:** El crecimiento en Cristo no es automático. Alguien podría aun ser un "niño en la fe" después de muchos años en la iglesia (a lo Mexicano: gente en la iglesia que llamamos hipócrita!) Leer **Hebreos 5:13; 1 Cor 3:1,2**. **El crecimiento requiere esfuerzo**, pero aquellos que son espiritualmente perezosos simplemente seguirán el curso de la menor resistencia; los tales serán siempre "niños" (o a lo Mexicano... ooopss!), si es que no caen del todo.
- 2. El otro obstáculo es el DESÁNIMO:** Conoces a esas personas que tienen un buen inicio, pero caen en el desánimo y abandonan el camino, o eres Tu uno de ellos? Las razones varían: problemas en la iglesia con la gente chismosa, perezosa, líderes que no sirven sino para crear problemas, falta de ánimo por parte de los demás, problemas personales, financieros, etc. Mire el ejemplo del apóstol Pablo: Pocos de nosotros podríamos tener los problemas que él tenía, Leelos: **2 Cor 11:24-29**. Aun así él no se "desanimó" **2 Cor 4:8-9** ¿Por qué? Porque él sabía que su labor no era en vano **2 Cor 4:16-5:1** Y de esta manera él nos anima a no cansarnos de hacer lo bueno **Gálatas 6:9; 1 Corintios 15:58**.
- 3. LA LEY DEL DESUSO:** Un cuchillo permanece brillante cuando se usa, pero si no es usado se oxide. ¡Así es con los hijos de Dios, perdemos lo que sabemos, la habilidad, y la oportunidad que tenemos cuando no las usamos! **Hebreos 2:1**.
- 4. LA LEY DE LA INTERFERENCIA:** Las cosechas, los árboles y las flores no crecen bien cuando están amontonadas. Así nuestro crecimiento espiritual será obstaculizado si permitimos que otros atropellen nuestra vida espiritual. El trabajo-dinero podrían llegar a ocuparnos tanto, supuestamente, para atender los negocios de Dios. Tantas cosas en la casa, limpiar, las actividades de los niños nos "ocupan tanto" que podrían llegar a tener a decir tengo poco tiempo para Dios. Los jóvenes podrían llegar a estar tan ocupados en las actividades escolares que la oración, la adoración, las buenas obras y el estudio de la Biblia estarían atropellando su vida espiritual. Los predicadores podrían estar tan ocupados con las reuniones, con las actividades administrativas, etc., que ellos tendrían tanto por hacer que no tengan tiempo para estar a solas con Dios. Jesús advirtió acerca del peligro de la interferencia – **Mr 4:18-19** En un esfuerzo para prevenir el sucumbir a estos obstáculos, aquí están algunas: **SUGERENCIAS PARA CONTINUAR NUESTRO CRECIMIENTO ESPIRITUAL** : * **HÁGASE ACTIVO EN su parroquia**, Aun el servicio más humilde puede ser una fuente de gozo para aquellos que lo están haciendo para agradar a Dios – ver **Sal 84:10; Jn 13:12-17**. * **Dedique tiempo cada día para estar a solas con Dios**. * **Estudie la Biblia**. * **Guíe a otros a Cristo**. * **Hágase un examen de conciencia constante**.

Bendiciones en tu nueva vida balanceada!



Foro comunitario con el congresista Paul Ryan

Viernes Julio 26
de 12:00-1:30pm

En san Patricio Unámonos!



DULCERIA

LA CHAPIS

1326 Douglas Av
262 634 8004



Mathew "Mateo" Luening

ABOGADO
414 383 9800

Servicios Legales bilingues



262 633-8633



Mario Martinez, Agency Inc
Auto * Home * Business
Medicare solutions
Racine: Mario Kenosha: Adrian
262 456 0321 262 496 0180

Anunciate aqui



Sirviendo a la comunidad en los momentos mas dificiles!

1001 High St Racine 262-632 5101

AGOSTO 2013

Viva Festival La Fiesta!

HORARIOS DE OFICINA:
9:00-3:00PM
PR. JHON FREDDY CORREA
262 634 5515

Emaus
Camina contigo!

en las 4 Millas

7 Y 8 SEPTIEMBRE

1015 4 MILE RD. RACINE



GRUPO FURIA DE CHICAGO



GRUPO LA KUSA
De Tierra Caliente

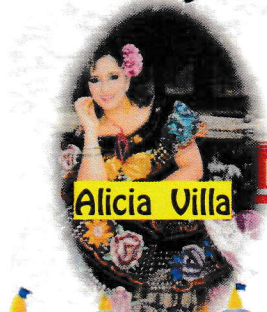

Alicia Villa



MARGARITO CORONA



SOTO'S RENTALS

262-721 5693

Juegos



BRINCOLINES GALVAN
637 0766



SHOW DE MAGIA



BLANCA

JUEGOS • MUSICA • COMIDA

BAILABLES, RIFAS Y MUCHO MAS

FREE ENTRY

Toro loco

Sabado de 1pm-8:00pm
Domingo 10am-6pm

Santa MISA
10:00 am

ALCAPONE

MI Jacalton

EMAUS ERES TU!

Emaus recuerda a nuestros Santos

El Viernes PRIMERO DE NOVIEMBRE en Emaus recordaremos a todos nuestros santos Noviembre 1ro en una Santa celebracion a las 6:00pm.

Quieres sentir la union del cielo con la tierra?

Ofrece un planta en memoria de ese ser querido!

Creemos el jardin del cielo en medio de nosotros!



EN OCTUBRE A RECOGER PUMPKINS



CLASES DE INGLES:

Empiezan en Septiembre Todos los miercoles a las 6:00pm. Deseas cenar? 5:30pm

CLASES DE G.E.D

Empezia en Septiembre Martes y Jueves de 6-8pm.



CONSTRUYE COMUN UNIDAD

ofrece una comida Emaus en Octubre y Noviembre.
Registrate llamando a : Antelmo al (262) 378 1345

Oct 6 : _____

Oct 13: _____



Oct 20: _____

Oct 27: TODOS de TRAJE (Traje frijoles, carne, arroz..)

Nov. 5: _____

Nov. 11: _____

Nov. 18: _____

Bendice a otros! Dios se encargara de bendecirte!

Interesada en ser CATEQUISTA?



Bendición de la Sagrada creación

Octubre 6

11:00-
11:15am



Alimentate espiritualmente de las reflexiones colocadas por el Pr. Jhon en Facebook.

Busca



Recibe mensajes y anuncios comunitarios de tu parroquia en tu CELULAR. Manda un texto al 414 881 1403 y registra tu celular

Esta bien amarte a ti mismo - antes de AMAR a tu pareja?

ESTUDIO BIBLICO: Lee Santiago 2:8, ¿cuál es la ley real? ¿Está bien amarse uno a sí mismo? (Lee Mateo 22:35-40) ¿Por qué no es posible amar al otro si no nos amamos a nosotros mismos? ¿Cuál es la base de poder amarnos a nosotros mismos? 1 Juan 4:10,19

¿Cómo puede el marido demostrar su amor? Efesios 5:28-31 El amor que tengo para mí se basa en el valor que pongo sobre mí mismo. ¿Cómo podemos enfocarcorrectamente nuestra autovaloración? (Osea valorarnos a nosotros mismos) Jeremías 9:23-24 1 Samuel 16:7 2 Corintios 10:12

Para Dios, ¿qué vale más: todas las cosas que este mundo tiene, o una sola alma como la tuya? Marcos 8:36

En el mercado, asignamos valor por medio del precio que ponemos sobre algo, o la cantidad que estamos dispuestos a pagar. Cuando Dios nos redimió (cuando nos compró en el mercado del pecado), ¿cuánto estaba dispuesto a pagar por nosotros? 1 Pedro 1:18-19

Resume los siguientes versículos sobre el tipo de amor que Dios nos ofrece en Cristo, primero para nosotros y luego para compartir con otros: Juan 3:16 Jeremías 31:3 Oseas 14:4 Isaías 63:9 Deuteronomio 6:5-8 Al mandamiento de amar al prójimo como a uno mismo, Jesucristo añadió un mandamiento nuevo y mucho más difícil: ¿cuál es? Juan 13:34-35

¿Cómo podemos experimentar y manifestar este amor? Juan 15:9 ¿Cómo se aplica este amor a la relación matrimonial? Efesios 5:25-27

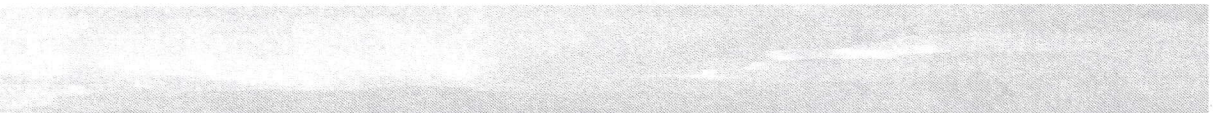

Proyecto de Mayordomía: “Dando a Dios con amor”

La biblia dice en Malaquías 3:10: “Traigan todos los diezmos al templo, para que haya suficiente comida en mi casa. Si lo hacen —dice el Señor de los Ejércitos Celestiales— **les abriré las ventanas de los cielos. ¡Derramaré una bendición tan grande que no tendrán suficiente espacio para guardarla! ¡Inténtelo!** ¡Pónganme a prueba! Dice el Señor.

Gracias a las personas que se han tomado conciencia y se han comprometido con el reino de Dios aquí en la tierra!



Lectura de Parejas: Leeremos el libro

“Las 5 Lenguas de l Amor” interesad@s- REGISTRATE!!!!

La medicina que necesita tu hogar!

Caja Comunitaria: Pan del cielo; abogados, consejería individual, parejas, familiar.

Eventos Juveniles!
Coming soon!!!



EMAUS ERES TU!

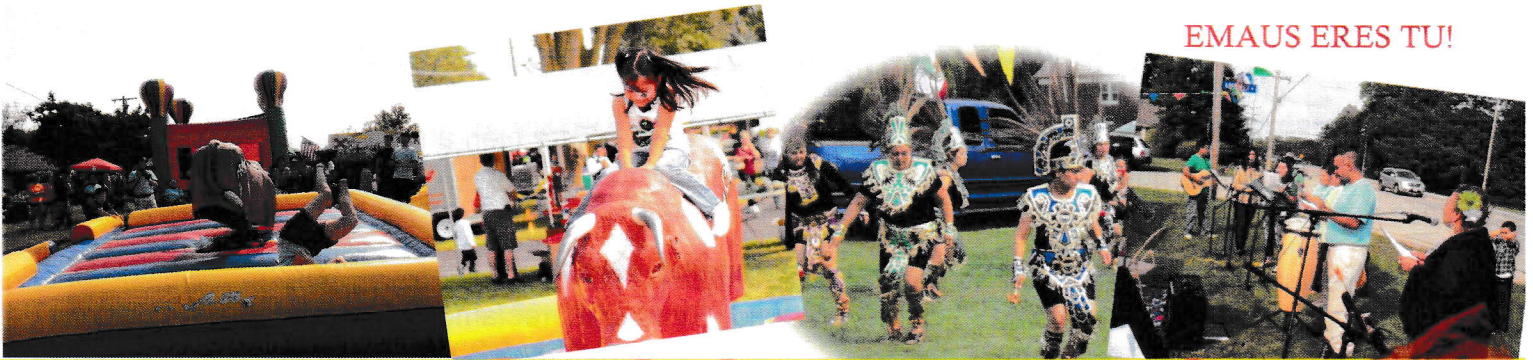

El Festival **VIVA LA FIESTA!** de las 5 iglesias FE ES ACCION Sera un Éxito!

Parroquia Emaus Te invita al

RETIRO ESPIRITUAL DE MUJERES LATINAS

Del 20 al 22 de septiembre de 2013

Regístrate!

262 634 5515

Colaboracion:

\$60 Niños (4-11 años) \$20

\$60

Manicure, pedicure, masaje,
yoga, facial y mucho mas!!!!

NIÑOS

SOLO \$20

*Eligiendo vivir en Armonía
con la Creación*

El maravilloso arte de servir a Dios y vivir a plenitud

El calendario de Actividades

- * Misa de Domingo 12:00pm
- * Clases de Coach
- * Se buscan: catequistas en Emaus
- * Clase de Primera comunión Sept. 25
- * Felicitaciones Lectores
- * Clases G.E.D empiezan en Agosto 21.
- * Prepárate Clases Ingles en Sept.
- * Oportunidades para ser voluntario
- * Clases de confirmaciones
- * Regístrate FACEBOOK y Textos
- * Cena Comunitaria con St. Patricio
- * Comité de las tres iglesias:
Cristo Rey, San Patricio y Emaús
- * Quien cocinara en Octubre?
- * Jóvenes
- * Informe de las 5 iglesias trabajando juntos!

Mi Jacalito
Restaurant
262 633-8633

ASEGURA
INSURANCE AND FINANCIAL SERVICES
Mario Martinez, Agency
IncAuto * Home * Business
Medicare solutions
Racine: Mario Kenosha: Adrian
262 456 0321 262 496 0180

DULCERIA
LA CHAPIS
1326 Douglas Av
262 634 8004

Mathew "Mateo" Luening
ABOGADO
414 383 9800
Servicios Legales bilingues

**Anunciate
aquí**

**Funeraria
Strouf**
Sirviendo a la comunidad en los momentos
mas difíciles!
1001 High St. Racine 262-632 5101

El calendario de Actividades

Confirmaciones – empiezan Octubre 11- Viernes 6-8pm; Sábados 9:00am-10:30am

Primeras comuniones (Miércoles 5:30-7:30 pm y Sábados 10:00am) se cierran las inscripciones Oct 23.

* Clases de Coach

* Se buscan: catequistas en Emaus

* Clase de Primera comunión Sept. 25

* Clases G.E.D.

* 6:00pm Clases Ingles Miércoles cena 5:30pm empiezan Octubre 16.

* Oportunidades para ser voluntario

* Regístrate FACEBOOK y Textos

* Cena Comunitaria con St. Patricio

* Grupo de Jóvenes-Grados 9-12 (2 & 4 viernes 6-8pm)

* REUNION HISTORICA: Comité de las tres iglesias: Cristo Rey, San Patricio y Emaús Octubre 16 a las 6:00pm en Cristo Rey

* Quien cocinara en Octubre?

* Informe de las 5 iglesias trabajando juntos!

* Grupo de apoyo Lunes 6pm

* interesado llama a Diane M 262 412 2070

Octubre 13 caminata por los pobres- para recoger comida

Deseas servirle a Dios en la Misa?

Leyendo comunícate con Lety 262 989 1839

Arreglando el altar, trayendo las ofrendas con Lupe 989 1842

Noviembre 10 Clase en Chicago para lo que se desean consagrar en un ministerio para servir a Dios!

OCTUBRE 2013

HORARIOS DE OFICINA:

9:00-3:00PM

MISA 12:00

PR. JHON FREDDY CORREA

Emaus

Camina contigo!

¡¡¡Saludos fraternales!!!

Ya nos estamos adentrando en una de las estaciones más hermosas y de cambio muy dramático en la naturaleza. El otoño se suele comparar con la madurez en el desarrollo humano que luego nos lleva al invierno que es la tercera edad.

Todos los que vivimos en países en el cual el otoño es muy marcado nos percatamos que durante esta estación

una variedad de cambios a diario. Los días son más cortos, las noches más largas, las temperaturas cambian hacia más frías cada día que pasa, hay días donde se siente mucho viento y lluvia y todos sabemos que las hojas se van cayendo. Los arboles van a “dormir” unos meses hasta la primavera.

Algo así como los cambios del otoño también nos pasa en nuestras vidas. Pasamos por muchos cambios normales, en algunos casos en los cuales hay días que sentimos en nuestro interior, como si el viento fuera muy recio y la lluvia muy torrencial, los días de un frío que se nos hiela el alma y de días cortos y noches de desvelo muy largas. Si cuando nos enfrentamos a momentos de dificultades y de tropiezos, de sufrimientos y penurias sentimos como si los cambios del otoño nos arrojan el alma.

Hermanos y hermanas sabemos que la primavera va a llegar.

Si es así, es el ciclo de la vida cuando lo vemos a través de los ojos de la gracia de Dios y su amor inmenso. Sí, sabemos y estamos seguros que la primavera llega, donde salen las flores y el día se ve más claro y le frío se ha aplacado.

Los arboles florecen y el ánimo cambia ya que confiamos en un Dios que nos sostiene y nos escucha en los momentos cruciales y contesta nuestro clamor. Vivamos en la esperanza de un mañana mejor disfrutando el día de hoy en la presencia del Espíritu Santo en nuestras vidas, mientras pasamos por nuestro otoño muy colorido y a veces de mucho frío y de vientos muy recios. Dios está con nosotros, ¡¡¡Aleluya!!!

Rev. Héctor Carrasquillo (Director Ministerios Latinos, Unidad Multicultural de la ELCA)



EMAUS ERES TU!

Emaus recuerda a nuestros Santos Viernes 6:00pm

El Viernes PRIMERO DE NOVIEMBRE en Emaus recordaremos a todos nuestros santos Noviembre 1ro en una Santa celebracion a las 6:00pm.

Quieres sentir la union del cielo con la tierra?

Ofrece un altar, planta en memoria de ese ser querido!

Creemos el jardin del cielo en medio de nosotros!



EN OCTUBRE 30 LOS NIÑOS DE LA DOCTRINA SE VAN A RECOGER PUMPKINS

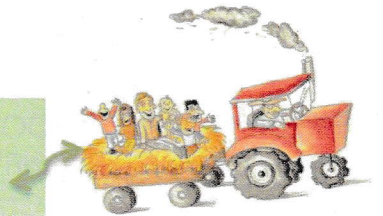

CLASES DE INGLES:

Empiezan Todos los miercoles a las 6:00pm. Deseas cenar? 5:30pm

CLASES DE G.E.D: Martes y Jueves de 6-8pm.



CONSTRUYE COMUN UNIDAD

ofrece una comida Emaus en Octubre y Noviembre. Registrate llamando a : Antelmo al (262) 378 1345

Oct 27: TODOS de TRAJE (Traje frijoles, carne, arroz..)



Nov. 5: _____

Nov. 11: _____

Nov. 18: _____

Nov. 25: _____

Bendice a otros! Dios se encargara de bendecirte!



Interesada en ser CATEQUISTA?

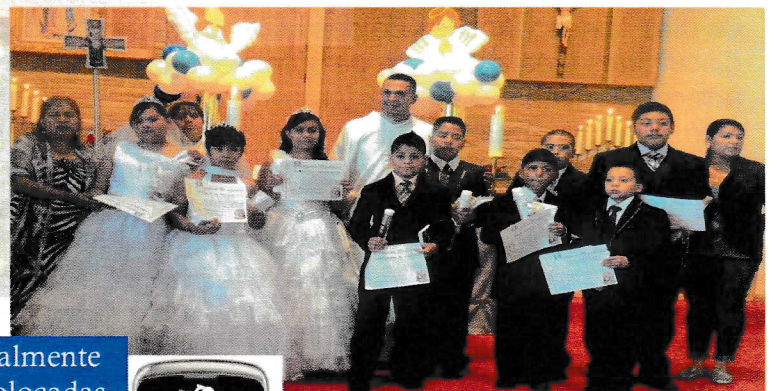
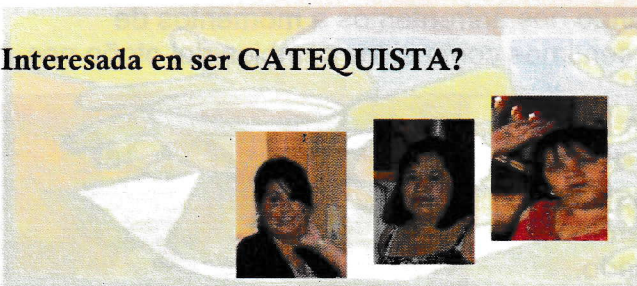

Alimentate espiritualmente de las reflexiones colocadas por el Pr. Jhon en Facebook.

Busca



Recibe mensajes y anuncios comunitarios de tu parroquia en tu CELULAR. Manda un texto al 414 881 1403 y registra tu celular

Comienzos.

Los niñ@s comenzaron la escuela, universidad, comienza el otoño, nuevos horarios- Que mas es nuevo en tu vida? Recuerda que no importa que estes pasando en estos momentos- TU puedes tener un nuevo comienzo aun si:

- Le han dicho que tiene una enfermedad incurable. Los médicos le han dicho que no hay esperanza o recursos médicos.
- Su matrimonio podría estar en ruinas.
- Su corazón podría es roto por un hijo o hija descarriado o por un compañero o padre que no tengan el alma a salvo de la condenación.
- Si usted sufriendo dificultades financieras o los efectos de abusos físicos o emocionales.
- Aun si usted esta leyendo este libro en una prisión, sirviendo una condena a cadena perpetua sin posibilidades de libertad controlada o esta aguardando su condena en el pabellón de la muerte. Usted podría pensar que es demasiado tarde, que no hay esperanza para un nuevo futuro.

Jesús declaro:

El ladrón no viene sino para hurtar, y matar, y destruir: yo he venido para que tengan vida, y



Proyecto de Mayordomía: “Dando a Dios con amor”

La biblia dice en **Malaquías 3:10**: “Traigan todos los diezmos al templo, para que haya suficiente comida en mi casa. Si lo hacen —dice el Señor de los Ejércitos Celestiales— **les abriré las ventanas de los cielos. ¡Derramaré una bendición tan grande que no tendrán suficiente espacio para guardarla! ¡Inténtelo!** ¡Pónganme a prueba! Dice el Señor.

Gracias a las personas que se han tomado conciencia y se han comprometido con el reino de Dios aqui en la tierra!



Lectura de Parejas: Leeremos el libro

“Las 5 Lenguas de l Amor” interesad@s-

La medicina que necesita tu hogar!

Caja Comunitaria: Pan del cielo; abogados, consejeria individual, parejas, familiar.

Eventos Juveniles!
2 & 4 Viernes 6pm



El Arte Sacro como medio de Evangelización en el Siglo XXI

Por: Revdo. Gabriel A. Marcano

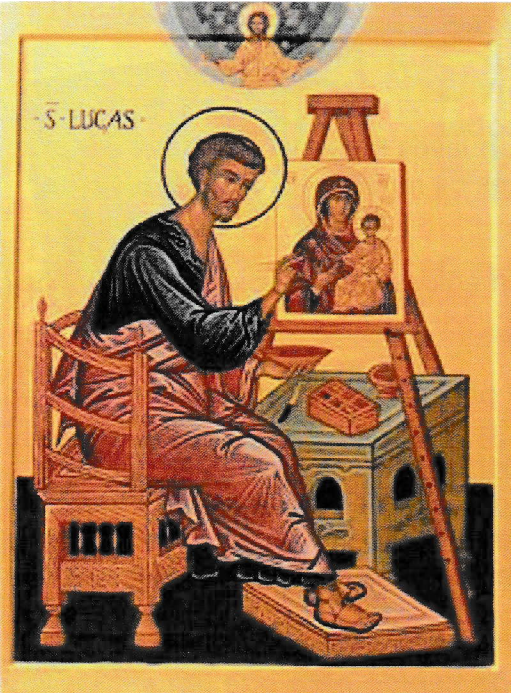

Hablar de “Arte” sagrado en este tiempo donde convergen tantas tendencias y van surgiendo nuevas reflexiones teológicas resulta al complejo. El arte para un Cristiano debe ser una invitación a la esperanza - virtud teologal – fuente de alegría que se fundamenta en una base sólida que es Cristo. Decía San Basilio: “*Lo que las palabras dicen al oído, el arte lo muestra en silencio*”. Y es que la fe gana en profundidad a la hora de contemplar un cuadro. Es decir; Una obra de arte sacro es incompleta si la fe está ausente...el artista no insiste, solo invita a la esperanza, a la contemplación como medio de oración. La filosofía clásica desde sus inicios, contempló la estética como una herramienta para entender lo bello (Platón, Aristóteles, Santo Tomás) dieron grandes aportes a la reflexión que hoy tenemos sobre del Arte. La cual es generada por la fe, es un relato

fascinante, un escenario que nuestro mundo aguarda y releva; porque para el hombre la culminación de la belleza es el amor, la capacidad de amar y sentirse amado el dar y recibir. El arte “cristiano” siempre ha estado al servicio de la Iglesia, ha sido durante siglos una de las herramientas más nobles capaz de anunciar a Cristo. La belleza tiene un poder inmenso en la evangelización de las culturas. La belleza del arte tiene además una fuerza pedagógica para introducirnos en el misterio de la Verdad; bastaría ver las grandes edificaciones antiguas cargadas de símbolos, imágenes que dieron paso al cristianismo. Han pasado más de 2000 años y todavía el cristianismo y otras grandes religiones se siguen sirviendo del arte como medio de evangelización. Cuando entramos a un templo y observamos la arquitectura, las formas los colores inmediatamente entramos en un estado de armonía con lo sagrado con lo místico. Es ese algo que nos lleva a tener un encuentro con lo divino. Si la belleza es capaz de iluminar al ser humano, su mente y corazón. Podemos también nosotros renovar nuestra mirada, abramos los ojos y el corazón -“effeté”- para poder percibir las puertas del cielo y poder decir como San Agustín “Tarde te amé, belleza antigua y nueva, tarde te he amado”.

		 <p>DULGERIA LA CHAPIS 1326 Douglas Av 262 634 8004</p>	 <p>Mathew “Mateo” Luening ABOGADO 414 383 9800 Servicios Legales bilingues</p>
 <p>Mi Jacalito Restaurant 262 633-8633 . .</p>	 <p>ASEGURA INSURANCE AND FINANCIAL SERVICES Mario Martinez, Agency IncAuto * Home * Business Medicare solutions Racine: Mario Kenosha: Adrian 262 456 0321 262 496 0180</p>	<p>Anunciate aqui</p>	 <p><i>Funeraria Strouf</i> Sirviendo a la comunidad en los momentos mas difíciles! 1001 High St. Racine 262-632 5101</p>

Emmaus Evangelical Lutheran Church

Noviembre 2013

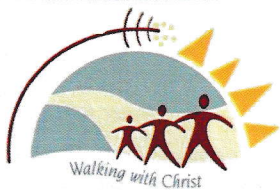

Horarios de oficina:
9:00 - 3:00 p m
Misa 12:00
Pr. Jhon Freddy correa

El calendario de Actividades:

Catequesis de Confirmación. Viernes 6-8pm; todos los primeros Sábado de mes 9:00am-10:30am

Primeras comuniones:

(Miércoles 5:30-7:30 pm y Sábados 10:00am)

Clases de Coach:

Clases G.E.D

6:00pm Clases Ingles Miércoles cena 5:30pm

* Oportunidades para ser voluntario

* Regístrate FACEBOOK y Textos

- Grupo de Jóvenes-Grados 9-12 (2 & 4 viernes 6-8pm)
- Novena a la Virgen de Guadalupe
- Posadas.

Querido hermanos la Parroquia Emaus te da la más cordial bienvenida. Somos una comunidad cristiana de confesión luterana, multicultural, que afirma que Dios nos acepta y perdona sólo por amor y gracia mediante Jesucristo su Hijo quien por su muerte y resurrección y a través de su palabra nos muestra el camino para que unidos unos a otros por el Espíritu Santo, podamos vivir y transmitir su mensaje de amor, justicia, paz y llegar a la vida eterna. Queremos ser fiel al mandato de Jesucristo, de predicar Su Palabra como Evangelio de la Gracia divina, de la salvación por Fe, de celebrar los sacramentos del bautismo y de la santa cena y de ayudar a los necesitados con actitud y proyectos. Vivimos y Celebramos la litúrgica, con énfasis en la predicación de la justificación del pecador por la gracia de Dios. Queremos promover una mentalidad de servicio y trabajo bajo la guía del evangelio, lo que significa creer sin dejar de razonar, con una mente abierta, crítica y tolerante, y servir a Dios en todo lo que hacemos en la vida diaria.

Adviento

*¡Ven y enciende
mi Fe, Señor,
para vivir en el
amor!*



¿QUÉ ES EL ADVIENTO?

Propiamente la palabra Adviento viene de la conjugación del verbo “venir” en latín (ad-venio) y significa propiamente “lo que esta por venir” o mejor “llegada” una presencia que ya ha comenzado. En el uso actual el adviento es un tiempo en que la Iglesia en su liturgia se prepara para la celebración del misterio de la encarnación del Señor; Dios viene y se acerca para nuestra salvación. Además el adviento tiene otras connotaciones pues, deja de ser sólo un acontecimiento conmemorativo, para hacerse actual y lanzarnos también hacia la meta definitiva de nuestra salvación.

Cosas a
tener en
cuenta...

“consejos prácticos para vivir el Adviento».

1. **DESPERTAR...** nada de gente dormida, ni gente desentendida de la realidad, tampoco quienes deleguen en otros el encargo de vigilar y trabajar; porque estas personas no sirven para el Reino.
2. **TENER CUIDADO...** especialmente dirigir a quienes se ocupan de sus propias cosas: no se acostumbren a vivir con un corazón insensible y endurecido, buscando llenar su vida de bienestar y placer, de espaldas al Padre del Cielo y a sus hijos que sufren en la tierra, porque los hará cada vez menos humanos.
3. **SER LÚCIDOS Y CRÍTICOS...** abrir los ojos y aprender a ver con los ojos de Dios. Ser críticos a los acontecimientos actuales, al hoy de tu hermano y al tuyo, para identificar aquellas cosas que oscurecen o entorpecen la venida del Señor.
4. **PREGUNTAR...** ¿Qué es lo que tiene que pasar Señor? ¿Qué tengo que hacer Señor para que se haga tú voluntad?
5. **VIGILAR...** “sean los “centinelas de la mañana”, los vigías que anuncian la luz del alba y la nueva primavera del Evangelio”
6. **CELEBRAR...** con gozo el acontecimiento de la aparición primera de la bondad y el amor de Dios en Jesús.



La Corona de Adviento con sus cuatro velas es un símbolo tradicional de Alemania difundido por todo el mundo. Representaba el ruego para que el dios-sol regresara con su luz y calor durante el invierno. Los cristianos luteranos, al ver en Jesucristo el origen de la vida y luz espiritual, adoptaron este símbolo para expresar y vivir su fe en torno a la persona del Mesías.

Dias de la novena a la Virgen de Guadalupe

Día	Familia	Dirección	Teléfono
1	Martínez	2816 Wright Av	664 1061
2	Alonso	1224 S. Memorial Dr.	822 5262
3	Hernando	1806 Arcturus	676 3400
4	Silva	429 N. Memorial Dr.	676 7210
5	Galicia	2330 Meachem St.	995 4167
6	Unledo	918 Hagerer St	880 3029
7	Calderon	1228 Buchanan	8226380
8	Emaus- Misa 12:00	1925 Summit Av	634 5515
9	Flores- González	914 Jackson	9891842
10	Guadalupe	1203 Carlisle A	880 7893
11/12	Emaus- <u>Misa 11:00pm</u>	Emaus	262 634 5515
	Mañanitas 12:00am		

Que nos dice Lutero sobre Maria:

La Veneración de Maria está inscrito en las profundidades del corazón humano (Sermón, Setiembre 1, 1522)



Esta es una dulce y pía creencia que la infusión en el alma de María fue efectuada sin pecado original; por lo tanto en la verdadera infusión de su alma ella fue también purificada del pecado original y adornada con los regalos de Dios, recibiendo un alma pura instilada por Dios; por lo tanto desde el primer momento ella empezó a vivir libre de todo pecado (Sermón “En el día de la Concepción de la Madre de Dios”, 1527)

CAMINEMOS CON MARIA TRAS
LAS HUELLAS DE SU HIJO...

COMIENZAN LAS NOVENAS

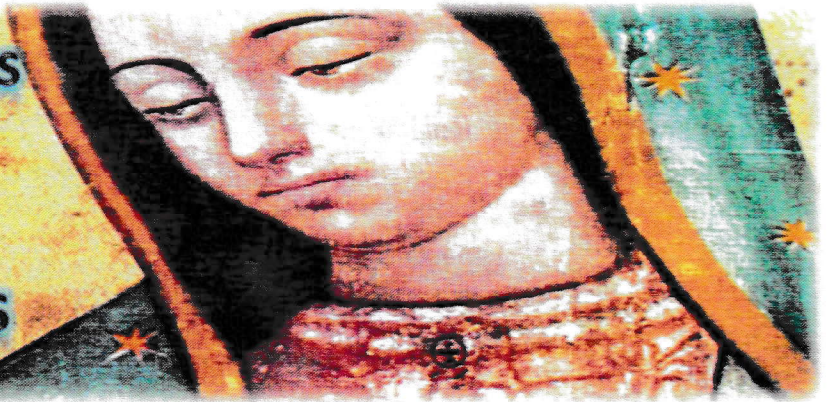

ASI FUE LA FIESTA CON LOS NINOS

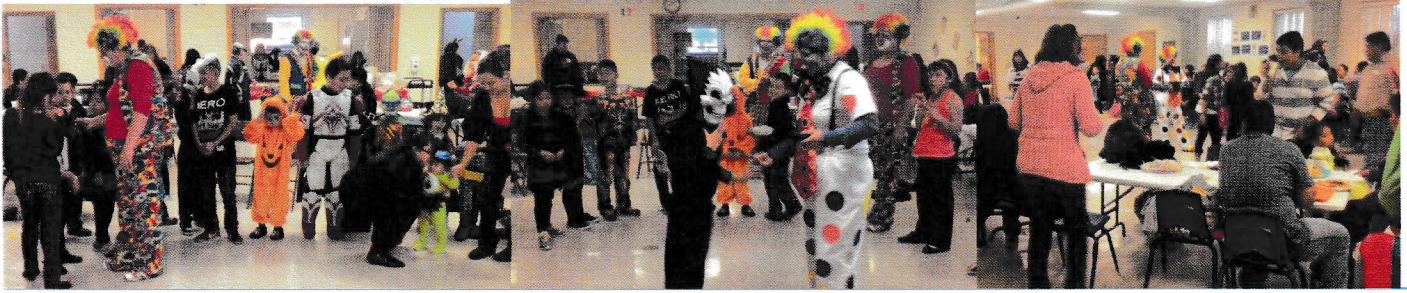

Gracias a todas las familias que nos acompañaron durante los nueve días de las novenas por los difuntos. Esperamos que podamos seguir caminando juntos en la fe. Ahora vamos a unirnos para acompañar a la madre de Dios durante la novena a Nuestra Señora de Guadalupe.

Mi Jacalito

Restaurant
 262 633-8633 . .

ASEGURA
 INSURANCE AND FINANCIAL SERVICES

Mario Martinez, Agency IncAuto *
 Home * Business Medicare solutions
Racine: Mario Kenosha: Adrian
 262 456 0321 262 496 0180

DULGERIA LA CHAPIS

 1326 Douglas Av
 262 634 8004

Mathew "Mateo" Luening
ABOGADO 414
 383 9800 *Servicios*
Legales bilingues

Anunciate aqui

Funeraria Strouf

Sirviendo a la comunidad en los momentos mas difíciles!
 1001 High St. Racine 262-632 5101

Emaus

CONSTRUYEME UN TEMPLO

Unete haz la diferencia!

Es nuestro caminar con Dios, La Virgen María, San José y **Jesús!!!**

Las posadas? Nosotros hoy somos peregrinos inmigrantes en una tierra extranjera como la Virgen María, José y Jesús, pidamos a Dios que nos ensene el secreto de ser buenos peregrinos!

Ven y disfruta, aprende, recuerda, come, juega, canta, conoce nuevos amigos y mucho más!

REFLEXIONES: UN POCO DEL CORAZÓN PARA EL ALMA.

El Corazón.

Ese órgano que late y late desbordando vida. Haciendo correr mi sangre por todas mis venas. Y como esa sangre un sinfín de sentimientos. Amor a mi prójimo, mis padres, a la vida y sobretodo a Dios. Son tantos los sentimientos que ese pequeño órgano llamado corazón pareciera no poder con toda la carga, él solo. Esos sentimientos nos llenan de júbilo, dicha, amor, coraje, celos, y en algunas ocasiones odio-venganza. Sin este órgano somos como una vasija vacía. Por eso en esta temporada de Navidad te ruego Dios que hagas latir a mi corazón: late y late corazón mío!, más y más duro!. Para que día a día sepa que estoy viv@ y te dé gracias Dios Santo por todos tu regalos y por la bendición de tener un día más!

Por que negarlo?

Porque siempre niego cuando me equivocó y busco culpables al instante?

Parece como sino deseo asumir mí culpa o Error. En mi loca obsesión no hay duda que hiero y lastimo a los que a mi lado están. Es curioso, como enseño a mentir a mis hijos cuando les digo si preguntan por mi diles que no estoy. Y cuando ellos mienten con un grito los corregirlos. No será mi culpa que ellos mientan? O que tal cuando Yo digo groserías? Nada pasa no cierto? Que estas enseñando?

Dónde aprenden nuestros hijos? Tan fácil de echarle la culpa a la escuela, a los amigos, o tal vez decimos fue madre pues siempre l@ consiente demasiad@. Aun no se, NO LO SE... SI LA CULPABLE ES ELLA? YO? Ummm NUNCA LO HAGO.



GRACIAS GUADALUPANOS DE CORAZON!

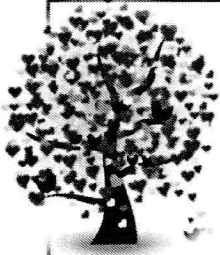

Braulio Sorio, Jose & Maria Miranda, Hermelinda Vega, Familia Veronica Cardona, Familia Otiz (Juan), Familia Martinez, Familia Correa-Moncada, Joaquin, Rubio, Ricardo Molina, Juana Ortiz, Adelina Suarez Llamas, Carolina Cervantez, Lupe Flores, Leti Flores Maria De La Luz Zetina, Jesus Y Maribel, Presciliano Ortiz, Soledad Beltran, Angelica, Leticia Salcedo, Roberto y Jose Mejia Castro, Noemi Ortiz y Humberto Ortiz, Veronica Medina, persona Anonima, Silvia, Balvina,

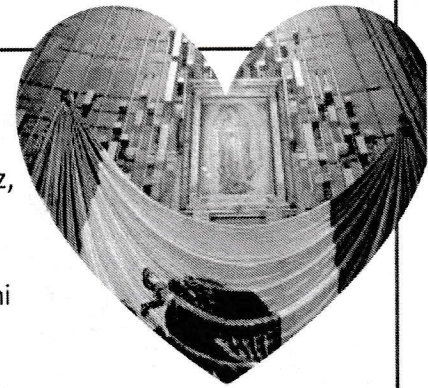

RECUERDA!!!! *Santa misa DE NAVIDA DICIEMBRE 24 A LAS 6:00PM:*

Posada especial para los niños! **Diciembre 22 @ 12:00am**



Cristo Rey, San Patricio y Emaus están haciendo historia en Racine!

El año 2012 nos deja muchos regalos, uno de ellos muy especial es la Amistad y el trabajo con el Pr. Anthony y el equipo de lideres de cada uno de las parroquias que son parte del equipo visionario que cree que Dios esta haciendo cosas grandes en Racine. Estos lideres buscamos la unidad, y la transformación de esta ciudad en un pueblo, una familia que luchemos juntos por justicia y el pan de cada día en nuestras mesas.

Gracias doy a Dios por este gran regalo! Gracias a ti por creer que es posible! La unidad, y el trabajo en equipo! No te pierdas el evento comunitario de familia. Juego de basketball Sacerdotes en contra de los jóvenes. Y mas!!!! Enero Viernes 10, 2014 de 6:00-9pm en san Patricio!

DANDOLE DINERO, TIEMPO Y MIS TALENTOS A DIOS
ERES UN BUEN MAYORDOMO DE LO QUE DIOS TE REGALA?

“Dando a Dios con amor”

GRACIAS a las personas que se han comprometido a ayudar a Dios a que siga haciendo grandes cosas por la comunidad a través de la parroquia Emaus!

Te invito a pensar en esto: Dios te ha prometido que multiplicara lo que tu le des: también dice que todo lo que hagamos por aquellos los más necesitados se lo hacemos a El!.

Nuestro compromiso es con Dios!!!!

Alimentate espiritualmente de las reflexiones colocadas en Facebook.

Busca Parroquia Emaus (ELCA)

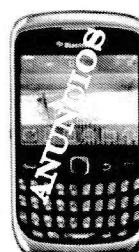

Recibe mensajes y anuncios comunitarios de tu parroquia en tu CELULAR. Manda un texto al 414 881 1403 y registra tu celular

El regalo

SIEMPRE SENTIMOS ALEGRÍA CUANDO ALGUIEN NOS DA UN REGALO Y TRATAMOS DE PONERLO POR UN TIEMPO EN UN LUGAR ESPECIAL. DONDE NO SE ROMPA O SE MALTRATE, Y LO CUIDAMOS CON MUCHO CARIÑO. CON EL TIEMPO SE NOS OLVIDA Y SE VUELVE UN OBJETO MAS DE LA CASA Y TERMINA MUCHAS VECES EN UN RINCÓN. PUEDEN PASAR AÑOS Y NI TE ACUERDAS. HASTA QUE UN DÍA VIENE ESA PERSONA QUE TE LO DIO Y TE PREGUNTA: "TE SIRVIÓ MI REGALO? O AUN LO CONSERVAS? Y TU SOLO CONTESTAS, QUE SI.....TE A SERVIDO Y QUE LO GUARDAS MUY BIEN. AHORA, DIME: QUE ES LO QUE HAS HECHO CON EL REGALO QUE TE OBSEQUIO DIOS? EL NOS DIO LA VIDA DE SU PROPIO HIJO PARA NUESTRA SALVACIÓN. NOS REGALA UN DÍA MAS DE VIDA Y NOS BENDICE A DIARIO. LO HAS VUELTO COMO ESE REGALO QUE PERDIÓ VALOR Y SIMPLEMENTE NUNCA LO USASTE O LO HAZ DEJADO EN UN RINCÓN? HOY ES EL DÍA PARA QUE PIENSES QUE ES LO QUE HACES CON ESE HERMOSO REGALO DE VIDA Y SALVACIÓN QUE TE DIO NUESTRO SEÑOR. SOLO TE PREGUNTO QUE VAS A CONTESTAR CUANDO EL TE PREGUNTEN QUE HICISTE CON ESE REGALO?

Caja Comunitaria: Pan del cielo; abogados, consejería individual, parejas, familiar.

CLASES DE INGLES SE REINICIAN EN ENERO 15:

VEN Todos los miércoles a las 6:00pm.
Deseas cenar? 5:30pm



GED

en Español

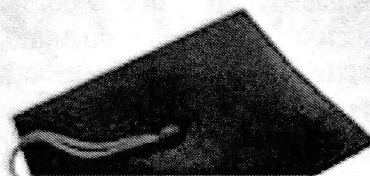

Dias: Martes y Jueves

Hora: 6:00 PM a 8:PM

Lugar: Parroquia Emaus (ELCA)

Para los adultos que estan interezados en seguir sus estudios de secundaria. El GED es el equivalente de un título de secundaria/Preparatoria. La meta de éste programa es la preparación de adultos para pasar el examen del GED y que puedan en el future estudiar una carrera técnica en MATC.



Para mas informacion llamar al 414 610 9678



CLASES DE GED
EN ESPAÑOL
GRATIS

LA
OPORTUNIDAD
PARA
ADQUIRIR LA
EQUIVALENCIA
A LA
PREPARATORIA

PARROQUIA EMAUS
(ELCA)

1925 Summit Ave
Racine, WI 53404
262 634 5515

Acompañemos a la sagrada Familia: La virgen María, San José y Jesús durante todo el tiempo. No solo es 12 de Diciembre, no solo las novenas o posadas. Dios quiere que le sigamos fielmente!!

Dia	Familia	Direccion	Telefono
16			
17	Diana Valencia	Hall en la Iglesia San Patricio	414 336 5315
18			
19	Marcelo	1630 Charles St	672 8946
20	Erika y Magdalena	1330 Erie St	909 9257
21	Trini y Antelmo	1806 Arturus Av	676 3400
22	Familias Florez-Cervera	Parroquia Emaus- Misa 12:00	
23			
24	Misa de Navidad <i>No dejes a la virgen- a Jesus- a Jose solos en el parto! Ven y recibe la alegria del bebe!!</i>	Parroquia Emaus (ELCA) 6:00pm	634 5515

6:00pm

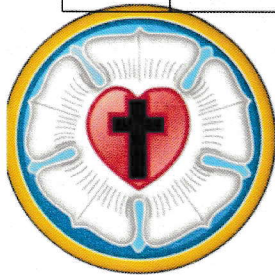

LA ROSA DE LUTERO

La rosa, un distintivo de la teología luterana. Se compone de cinco elementos: la cruz negra, el corazón rojo, los cinco pétalos blancos, el fondo azul y el anillo dorado. Cada parte tiene su significado:

1. **La cruz negra**, al centro del emblema recuerda que en Jesús, Dios viene a nuestro encuentro sacrificando su vida y venciendo el poder de la muerte en nuestro favor. Para que todo aquel que cree en él, no muera sino tenga vida eterna (Juan 3.16).
 2. **El corazón** nos hace recordar que es por la fe que somos justificados. El color rojo es símbolo del amor que se dona y reparte. Así como Cristo nos amó, también los suyos se aman unos a los otros. Así como Cristo sirve a los suyos, ellos se sirven unos a los otros, cada cual conforme al don que recibió (Gl. 6.2)
 3. **Los cinco pétalos blancos** señalan que por la fe, que actúa en favor de la justicia y de la paz, tenemos alegría, consuelo y paz de Dios para con nosotros mismos y para con los unos y otros. Eso es lo que el color blanco simboliza.
 4. **El color azul** recuerda el cielo e inspira a la fidelidad a Dios.
 5. **El anillo dorado** recuerda el oro, metal mas preciado. Simboliza todo lo que Dios nos otorga por fe, en forma de señales: perdón, comunión, esperanza, sentido de vida, opción en el día a día.
- Ya que la rosa fue creada de manera bella y ordenada, también la iglesia está motivada a invertir creativamente en la confección de su plan misionero.

Mi Jacalito

Restaurant
 262 633-8633 ..

Anuncia tu negocio aqui

DULCERIA LA CHAPIS

 1326 Douglas Av
 262 634 8004

Mathew "Mateo" Luening
ABOGADO 414
 383 9800 *Servicios*
Legales bilingues

ASEGURA
 INSURANCE AND FINANCIAL SERVICES
 Mario Martinez, Agency IncAuto *
 Home * Business Medicare solutions
Racine: Mario Kenosha: Adrian
 262 456 0321 262 496 0180

Anunciate aqui

Funeraria Strouf

Sirviendo a la comunidad en los momentos mas difíciles!
 1001 High St Racine 262-632 5101

HOY EN MEDIO DE TANTA CONFUSION, MIEDOS, INSEGURIDADES: **X K LEER 1a**

Biblia? ME preguntó un joven de esta manera en un text!

Mi respuesta es esta muy sencilla: En medio de miedos, inseguridades y sin saber que nos depara el futuro – algo muy cierto es que Dios esta a cargo! Creo que cada familia debemos leer y estudiar la Biblia simplemente porque es la Palabra de Dios a nosotros. 2 Timoteo 3:16 dice que la Biblia es “inspirada por Dios”. En otras palabras, es Dios hablándonos. Hay muchas preguntas que los filósofos y la gente en general se han hecho y que Dios nos las responde en las Escrituras al leerlas y compartirlas: Por ejemplo: ¿Cuál es el propósito de la vida? ¿De dónde vengo? ¿Existe vida después de la muerte? ¿Cómo puedo ir al cielo? ¿Por qué está el mundo tan lleno de maldad? ¿Por qué me cuesta tanto trabajo hacer lo bueno? Adicionalmente a estas “grandes” preguntas, la biblia nos ofrece muchos consejos prácticos en áreas tales como: ¿Qué debo buscar en mi pareja? ¿Cómo puedo tener un matrimonio exitoso? ¿Cómo puedo ser un buen amigo? ¿Cómo puedo ser un buen padre / madre? ¿Qué es el éxito y cómo puedo alcanzarlo? ¿Cómo puedo cambiar? ¿Qué es lo más importante en la vida?

¿Cómo puedo vivir para que no tenga que arrepentirme en un futuro? ¿Cómo puedo complacer a Dios?

¿Cómo puedo obtener su perdón?

¿Cómo puedo manejar las circunstancias adversas y eventos injustos de la vida para salir victorioso?

Soy salvo o no? Y mucho mas- no tengas temores muy fácil leerla- dentro de este volante hay una guía breve para enseñarte como leerla! **ADELANTE!!!**

Emaus

4 ANIVERSARIO DE EMAUS :)



Gran celebration del 4 aniversario de Emaus



GRACIAS :)

Haciendo Historia



Mas de 500 personas...

EL alcalde, el jefe de la policia, el gran invitado el jefe de los Sheriff, el abogado del distrito de la ciudad (quien firma la visas u), mas de 5 firmas de abogados, profesores, miembros comunitarios... La lista es grande para mencionarlos a todos! **GRACIAS** por este hecho histórico.

Este es solo el comienzo!

Que se logro?

Lo mas importante el compromiso de crear un comité conformado por abogados, profesores, negociantes, y miembros comunitarios para revisar todas las quejas de abusos-discriminación.

Necesitamos tu apoyo y compromiso: Como puedes ayudar?

Recogiendo formas de quejas, motivando a otros a hablar, dándonos sugerencias, y ante todo orando!

Sabías que?

El

nombre más largo de la Biblia es Maher-salal-hasbaz. Isaías 8:3 "Y me llegué a la profetisa, la cual concibió, y dio a luz un hijo. Y me dijo el Señor: Ponle por nombre Maher-salal-hasbaz."

Goliat no murió de la pedrada que le diera el pastor David, sino por su propia espada (1º de Samuel 17:48-51)

En el libro de Jueces capítulo 8 versículo 30 dice que **Gedeón tuvo 70 hijos**.

El único personaje en la Biblia que se menciona que usó un reloj fue el Rey Acáz (2 Reyes 20:11).

Al contrario de lo que se cree, **quien cortó el pelo a Sansón no fue Dalila** sino un hombre. Ella sólo hizo que se durmiese en sus rodillas para que se lo cortasen (Jueces 16:19).

El cabello de Absalón era tan largo que se menciona era de doscientos siclos de peso real, es decir, 2 kilos o 4.409 libras. 2 Sa. 14:26.

Un joven estaba a punto de graduarse en el instituto, durante muchos meses había mirado un bonito coche deportivo en un escaparate de un concesionario; y sabía que su padre podía costearlo y le dijo que eso quería como regalo de graduación... a medida que se aproximaba el día de la graduación el joven esperaba una señal de que su padre le había comprado el coche; finalmente la mañana de la graduación su padre lo llamo a su despacho y le dijo; estoy orgulloso de tener un hijo bueno como tú y también le comentaba cuanto lo amaba y le regalo una caja bellamente envuelta. El joven curioso y un poco desilusionado abrió la caja y encontró una preciosa BIBLIA estaba forrada de piel y con letras de oro grabado su nombre. Enfadado le levanto la voz a su padre ¿con todo el dinero que tienes me das una BIBLIA? Y lo abandono violentamente... Paso mucho tiempo... el muchacho tuvo muchos éxitos en los negocios; tenía una preciosa casa y una bella familia. Un día se dio cuenta que su padre ya estaba demasiado anciano y pensó ir a su encuentro, no lo había visto desde aquel día de su graduación; pero antes de que pudiera organizarse recibió un telegrama en que le comunicaban el fallecimiento de su padre. El joven había heredado todo sus bienes, le pedían en el telegrama que se regresara a casa para que se hiciera cargo de todo; al llegar a la casa de su padre lo invadió una inmensa tristeza y arrepentimiento en su corazón y empezó a buscar sus documentos más importantes de su padre y en efecto encontró la BIBLIA aun impecable tal como lo había dejado hacía mucho tiempo. Con los Ojos llenos de lágrimas abrió la BIBLIA y empezó a pasar las paginas; su padre había subrayado cuidadosamente un versículo [Mateo 7—11] "pues si nosotros siendo malos damos cosas buenas a nuestros hijo. ¡Cuánto más nuestro padre que está en el cielo darán cosas buenas a los que se les pidan! Mientras leía estas palabras, una llave cayo de la portada del libro, esta llevaba una tarjeta con el nombre de concesionario y el nombre de coche deportivo que le había pedido a su padre. En la tarjeta estaba escrita la fecha de su graduación y la palabra pagado. Si cuantas veces nos perdemos de las bendiciones de DIOS porque no están envueltas tal como las esperábamos. Búscalas, lee la biblia! Habla con Dios! Abre los ojos y mira a tu alrededor todo lo que Dios te estará dando!

Con Cristo construyo mi Vida

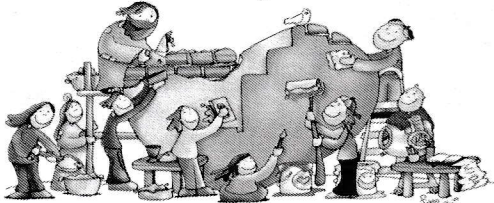

Facil- ESTUDIO BIBLICO EN FAMILIA

Lee Mateo 5:6-13: dale un título al Pasaje que sea distinto a *padre nuestro*:

Encuentra 5 palabras difíciles y 5 que se repitan?

Preguntas de observación: 1. ¿Quiénes intervienen en el pasaje? 2. Según Jesús, ¿Cómo quienes no debemos actuar cuando oramos? ¿Por qué? 3. ¿Cómo entonces afirma Jesús que debemos orar? 4. Haz un breve bosquejo de la oración de Jesús en los versículos 9-13?

Preguntas de Interpretación: Según el pasaje, ¿Es inconveniente orar en público? ¿Por qué? 2. ¿Qué significa usar vanas repeticiones? 3. ¿Hay evidencia de oración intercesora en el pasaje? 4. ¿Se puede deducir un orden en la forma de orar tomando como base los versículos 9-13?

Preguntas de Aplicación: 1. ¿Las oraciones en la actualidad son diferentes al modelo presentado por Jesús? ¿En qué? 2. ¿Hay algunas áreas que se incluyen en la oración modelo presentada por Jesús las cuales hemos descuidado en nuestra oración? ¿Cuáles? ¿Porqué las hemos descuidado?

Mi PLAN de Acción: Escribe, dos cosas que has descubierto que debes cambiar o mejorar en tu oración al compararla con las instrucciones de Jesús sobre la oración. Para cada una, nombra dos pasos para ayudarte a mejorar estos aspectos: Paso 1 es: _____ Paso 2 será: _____



reforma migratoria

2013



"LA ACTUALIZACIÓN"

June 10, 2013 by Linda Hartke

Reforma migratoria: ¿La veremos en el 2013? Ese es el tema prioritario en la mente de cada persona este año.

Un complicado proceso legislativo y debate están por venir. Para descifrar los titulares para usted está "LA ACTUALIZACIÓN", será una serie de comentarios semanales en Internet (facebook: Parroquia Emaus (ELCA). Expertos analizarán cómo los eventos recientes afectan las posibilidades para una reforma real. Los panelistas ofrecerán sus puntos de vista sobre lo que está sucediendo actualmente en el Capitolio, con el respaldo de sus décadas de experiencia con reformas migratorias y proceso legislativo.

Dados los más recientes acontecimientos, ¿estamos más cerca de la reforma migratoria? El Obispo Julian Gordy, Foro de Inmigración (Immigration Ready Bench), ELCA.

En tan sólo uno de gran cantidad de desarrollos difíciles de prever en el debate de la reforma, el congresista conservador Representante Darrell Issa (R-CA) la semana pasada aceptó públicamente el que los inmigrantes indocumentados tengan a su disposición una vía hacia la ciudadanía y el Senado parece estar listo para empezar a debatir el proyecto de ley de reforma completa, el S.744, tan pronto como esta semana Junio 10. Los prospectos de la reforma continúan cambiando y los jugadores que participan en el proceso continúan haciéndolo bastante interesante. Es de esperarse que esta semana, cuando el Senado en pleno encare este asunto, haya más cambios y reconfiguraciones. Pero también siento que, inevitablemente, las piezas encajarán y la reforma migratoria pronto será una realidad.

Lisa Sharon Harper, Directora de Movilización, revista Sojourners:

Hemos llegado a una importante coyuntura en la lucha por una reforma migratoria que tenga sentido común. El Senado en pleno está listo para debatir el proyecto de ley bipartidista aprobado por una clara mayoría mediante la Comisión de Asuntos Judiciales del Senado. La última vez que hubo un momento como éste fue en el 2007, pero en ese

entonces, el proyecto de ley de inmigración se colapsó en el piso del Senado. Dado el apoyo bipartidista de la Comisión de Asuntos Judiciales del Senado, creo que en el 2013 es posible que se obtengan mejores resultados, pero este progreso todavía podría verse estancado. Mientras nos preparamos para el debate en el Senado, las siguientes son mis principales preocupaciones: el Senado no debiera aprobar enmiendas que prolonguen la ruta hacia la ciudadanía ganada ni desmantelar más el sistema migratorio basado en la familia. Más bien, el Senado debería reconsiderar las multas económicas que actualmente se cobran a los indocumentados y sus familias. En gran cantidad de casos, las familias que intentan obtener la ciudadanía no podrían salvar este obstáculo. Públicamente muchos seguidores de Cristo en todo el país han manifestado claramente que apoyan la legislación que dé la bienvenida a los extranjeros, proteja a la familia, haga valer el estado de Derecho y brinde una oportunidad a las personas que aspiran a ser estadounidenses. Creo que, en 50 años, podremos mirar al pasado y decir a nuestros nietos y bisnietos que alzamos nuestra voz a favor del lado correcto de la historia en la lucha por una reforma migratoria justa en Estados Unidos. Sin embargo, la pregunta cuya respuesta está por verse todavía es: En 50 años, ¿podremos decir que "el Congreso nos escuchó"?

Brittney Nystrom, Directora de Cabildeo, el Servicio Luterano de Inmigración y Refugiados:

La semana pasada, el intentar predecir los resultados de las labores relacionadas con la reforma migratoria en el Congreso fue como mirar por un caleidoscopio. Cada día, el caleidoscopio cambiaba un poquito y las perspectivas también parecían cambiar. Nos enteramos de que, en la Cámara de Representantes, el Rep. Raul Labrador (R-ID) abandonó las negociaciones bipartidistas que intentan reformar el sistema migratorio. Asimismo, en la Cámara se aprobó un proyecto de ley de financiamiento que haría imposible que los jóvenes elegibles para la Ley DREAM vivieran sin temor a ser deportados y prohibiría ejercer la discreción para proteger a las víctimas inmigrantes del tráfico de personas y otros delitos. Sin embargo, con sólo mover el caleidoscopio de inmigración ligeramente, uno podía ver bastantes noticias positivas relacionadas con la reforma.

Diploma al Mejor Padre del Mundo:

Por estar siempre que te necesito,
y enseñarme con tu ejemplo
lo que es el esfuerzo y el trabajo,
por preocuparte cuando me enfermo,
por hablar conmigo de lo que sea,
por entenderme, tu cariño
y los buenos momentos.
Hoy quiero darte este Diploma
por ser así como eres...

"EL MEJOR PADRE
DEL MUNDO".

Hola mas de coach!!! New grupo empieza Junio 23 10:30am como ya hemos dicho, COACH es para quien desee tener a alguien mas caminando contigo. Entonces ya serán dos luchando por lo que tu deseas conseguir en tu vida! El mejor lugar para empezar en tu vida es donde te encuentras y la único que miramos es el futuro para ver a donde quieras llegar. En COACH hay una relación de confianza, apoyo, respeto. Y recuerda que el único objetivo es tu superación personal. Coach es ir al encuentro de lo que Dios quiere para tu vida y tu familia. "Coach en mi vida esta formando una influencia tan poderosa. Es una disciplina. Cada cosa que aprendo es tan beneficiosa para mi vida diaria, siento que cada día me conozco más, tengo mis objetivos y decisiones que debo tomar mas claras. Estoy aprendiendo a disfrutar la vida, se lo que quiero, y también lo que no quiero! Finalmente he visto una gran ayuda a través del COACH: "tomo mejores decisiones en mi familia, con mis hijas y todo lo que me rodea.

ANIMATE! Aprender coach es tan importante para cualquier persona sin importar si eres profesional o no. Cualquier persona puede hacerlo. La decisión la tienes tú. Dios tiene tantos regalos en ti! Descubre, disfruta y vive feliz! Eso es lo que Dios y coach quiere para ti. (Escrito por Soledad Beltrán)

Si tienes preguntas o quieres mas información llama: Pr. John F 262 634 5515, Soledad 262 721 6281 & Alex 262 930 5837



Gran reunión de tres Iglesias: Cristo Rey, St. Patricio y Emaus. Unidos en una sola voz planeando para hacer cada día un mejor trabajo en equipo por nuestra comunidad!

Regístrate **GRATIS** si es **FREE!** Cupos limitados- July 1-30 *
horario: 8:30-2:30pm

* **Campamento de VERANO GRATIS:** Niños de 6-11 años
** **Campamento de Jóvenes SALT** desde 11-16 años: Realizaran trabajo comunitarios, como pintar casas, limpiar la ciudad, visitar abuelitos, mucho mas, **Y DIVERSION!!!!**



ASEGURA
INSURANCE AND FINANCIAL SERVICES
Mario Martinez Agency, Inc.

- Auto
- Home
- Business
- Medicare Solutions

RACINE: Mario Martinez
(262) 456-0321

KENOSHA: Adriana Neave
(262) 496-0180

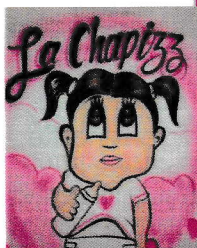

DULCERIA

LA CHAPIS

1326 Douglas Av

262 634 8004



Sirviendo a la comunidad en los momentos mas difíciles!

1001 High St. Racine 262-632 5101

Siguenos en
facebook
Parroquia
Emaus (ELCA)

Este es el templo-lugar donde nos reunimos

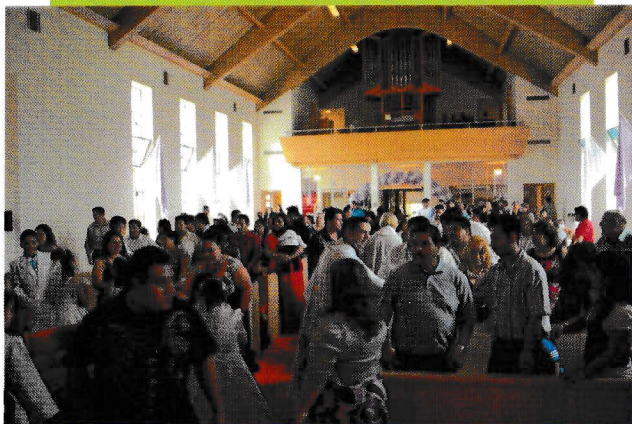

Unete!

Celebración de la virgen de Guadalupe



Los niños son una de nuestras prioridades



Bautizos, Primeras comuniones, confirmaciones, quinceañeras, bodas, unción de los enfermos, bendiciones y mas contáctanos para tener el gusto de caminar contigo!!!

1925 Summit Av. Racine WI 53404
(262) 634 5515



Parroquia Emaus (ELCA)



Misa Domingo 12:00
Misa de Sanacion una vez al mes

Parroquia Emaus (ELCA)

Comprometidos con la comunidad!

En Emaus caminamos juntos...

En el evangelio de San Lucas (capítulo 24) nos relata que Jesús se le apareció a dos de los discípulos en el camino cuando ellos iban tristes y sin esperanzas. Jesús camina con ellos, los acompaña, parte el pan y es así como ellos pueden ver. En Emaús compartimos, nos ayudamos y ayudamos a otros para así ver claramente el rostro de Jesús en los más pobres y necesitados. Únete



Programas- ayudas comunitarias

- * Programa después de la escuela para niños, todos los días.
- * Coro: clases de musica
- * Grupo de Danza Azteca
- * Clases de G.E.D
- * Clases de ESL
- * Grupo Pre-juvenil
- * Mundo Maravilloso: Doctrina de Primera comunión
- * Clases de confirmación
- * Campamento de Verano para niños: 5 semanas gratis
- * Pan del cielo: programa de remesas
- * Necesita hacer horas comunitarias?
- * Estudio bíblico
- * Pan del cielo
- * Consultas con Abogados 2 veces al mes.
- * Consejería familiar
- * Consejería de pareja
- * Consejería individual- confesiones
- * Cooperativa de sembrado



NavIDAR:
envio de remesas a
MEXICO

Nuestra meta en el 2012
Es: \$5,000 dolares